



TOPMET[®]

2018

LED profiles
profile LED

COVERS KLOSZE



A slide / wsuwany
white, frosted, transparent
mleczny, szron, transparentny



B slide / wsuwany
white, frosted, transparent
mleczny, szron, transparentny



C click / klik
white, transparent
mleczny, transparentny



C lens / soczewka
transparent
transparentny

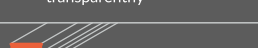

C1 click / klik
white
mleczny



D click / klik
white
mleczny



E slide / wsuwany
white, frosted, transparent
mleczny, szron, transparentny

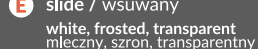

E7 click / klik
white
mleczny



F click / klik
white, transparent
mleczny, transparentny



G slide / wsuwany
white, frosted, transparent
mleczny, szron, transparentny



H slide / wsuwany
white, frosted, transparent
mleczny, szron, transparentny



I click / klik
white, frosted
mleczny, szron



J slide / wsuwany
white, frosted, transparent
mleczny, szron, transparentny



K click / klik
white
mleczny

MOUNTINGS MOCOWANIA

T



T mounting plate
uchwyt **T**

T connector 180 deg
łącznik **T** 180 st



U



U flexible mounting plate
uchwyt **U** sprężysty



cone U flexible mounting plate
uchwyt **U** sprężysty
cone

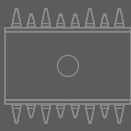

rack U flexible mounting plate
uchwyt **U** sprężysty
rack

W

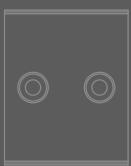

cone W flexible mounting plate
uchwyt **W** sprężysty
cone

white, inox, black
biały, inox, czarny

X



X mounting plate
uchwyt **X**

X connector 180 deg
łącznik **X** 180 st



Y

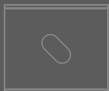

Y flexible mounting plate
uchwyt **Y** sprężysty



cone Y flexible mounting plate
uchwyt **Y** sprężysty
cone

Z



Z flexible mounting plate
uchwyt **Z** sprężysty

white, inox, black
biały, inox, czarny



cone Z flexible mounting plate
uchwyt **Z** sprężysty
cone

white, inox, black
biały, inox, czarny



TOPMET[®]

2018

LED profiles
profile LED



TOPMET LED profiles

profile LED TOPMET

Tutorial / Krok po kroku _____ 1.1



surface LED profiles

profile LED powierzchniowe

| | |
|------------------------|------|
| SLIM8 A/Z | 2.1 |
| SMART10 A/Z | 2.5 |
| SURFACE10 BC/UX | 2.9 |
| BEGTON12 J/S | 2.13 |
| UNI12 BCD/U | 2.17 |
| SURFACE14 EF/TY | 2.21 |
| SMART16 B/U4 | 2.25 |
| LINEA20 EF/TY | 2.29 |
| WIDE24 G/W | 2.41 |

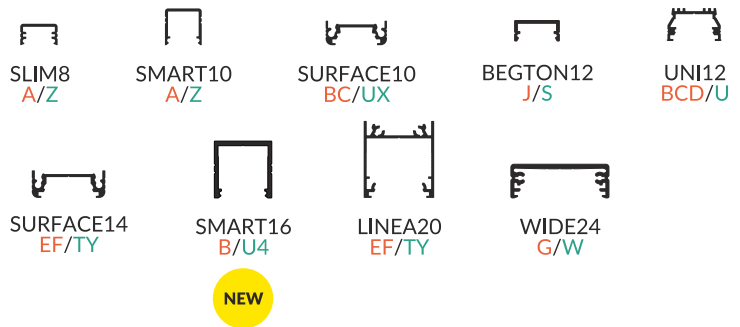

recessed LED profiles

profile LED wpustowe

| | |
|-------------------------|------|
| FLAT8 H/UX | 3.1 |
| HI8 C1 | 3.5 |
| DEEP10 BC/UX | 3.9 |
| GROOVE10 BC/UX | 3.13 |
| SMART-IN10 A/Z | 3.17 |
| BEGTIN12 J/S | 3.21 |
| FLOOR12 K/U | 3.25 |
| GROOVE14 EF/TY | 3.29 |
| LINEA-IN20 EF/U7 | 3.33 |

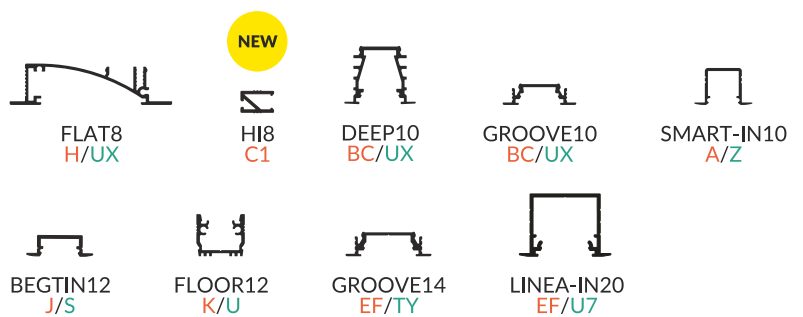

corner LED profiles

profile LED kątowe

| | |
|------------------------|------|
| TRIO10 BC | 4.1 |
| CORNER10 BC/UX | 4.5 |
| QUARTER10 BD/U6 | 4.9 |
| CABI12 E | 4.13 |
| CORNER14 EF/TY | 4.17 |
| CORNER27 G/UX | 4.21 |

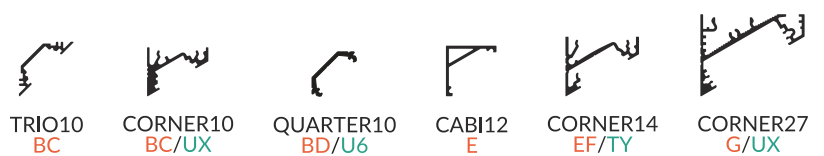

special application LED profiles

profile LED specjalne

| | |
|-----------------------|------|
| PEN8 I | 5.1 |
| BACK10 A/UX | 5.5 |
| STEP10 C | 5.9 |
| AMBI12 C | 5.13 |
| ARC12 CD/U5 | 5.17 |
| FIX12 / FIX16 | 5.21 |
| OUTSTAIRS12 BC | 5.23 |
| WALLE12 BCD | 5.27 |
| FRAME14 BC/Q | 5.31 |
| OVAL20 BC | 5.35 |

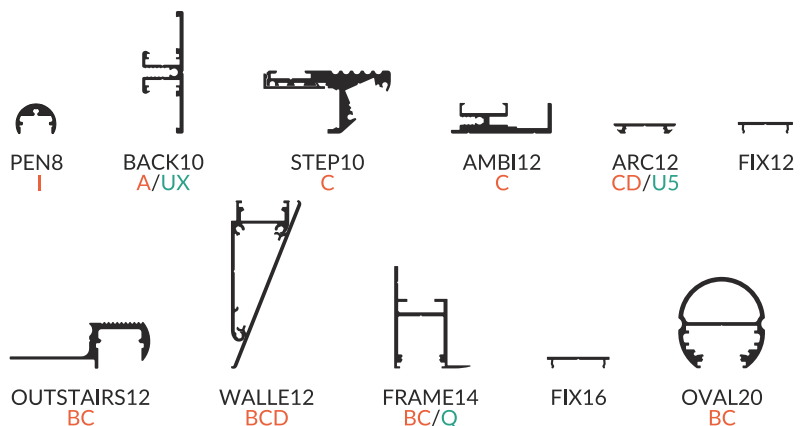

glass application LED profiles

profile LED do szkła

| | |
|-----------------------|-----|
| TWIN8 | 6.1 |
| MIKRO10 | 6.3 |
| EDGE10 BC | 6.5 |
| MIKRO-LINE12 J | 6.9 |



VARIO30

VARIO30

| | |
|-------------------|------|
| VARIO30-01 | 7.6 |
| VARIO30-02 | 7.6 |
| VARIO30-03 | 7.6 |
| VARIO30-08 | 7.6 |
| VARIO30-09 | 7.7 |
| VARIO30-10 | 7.7 |
| FIX 16 | 7.7 |
| VARIO30-04 | 7.14 |
| VARIO30-05 | 7.14 |
| VARIO30-06 | 7.14 |
| VARIO30-07 | 7.14 |

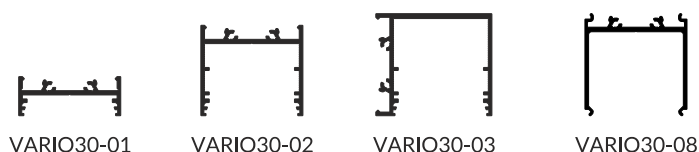
SURFACE / NAWIERZCHNIOWE**POWER SUPPLY PROFILE
PROFIL ZASILAJACY****ASSISTANT PROFILES
PROFILE POMOCNICZE****RECESSED - SPACKLE FLANGE MOUNTING
WPUSTOWE DO SZPACHLOWANIA****RECESSED
WPUSTOWE****big profiles**

duże profile

| | |
|-----------------------------------|-----|
| PHIL53 | 8.2 |
| PHIL recessed / PHIL wpust | 8.2 |
| LOWI | 8.3 |

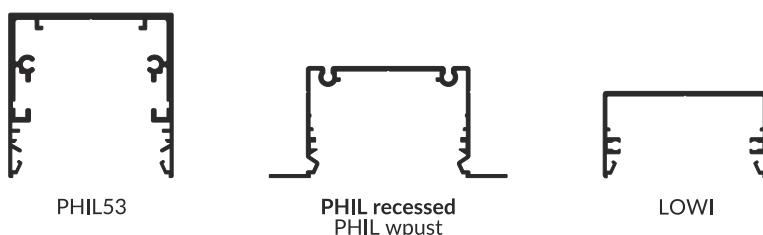
**LED accessories**

akcesoria LED

| | |
|---|------|
| PREMIUM LED strips / taśmy LED z serii PREMIUM | 9.2 |
| STANDARD LED strips / taśmy LED z serii STANDARD | 9.3 |
| BUDGET LED strips / taśmy LED z serii BUDGET | 9.3 |
| TOPMET Light PREMIUM LED modules / moduły LED PREMIUM TOPMET Light | 9.4 |
| LED power supplies / zasilacze LED | 9.5 |
| OSRAM LED power supplies / zasilacze LED OSRAM | 9.6 |
| power supply cases / obudowy do zasilaczy | 9.7 |
| lighting controllers and switches / czujniki sterujące i włączniki | 9.8 |
| RGB lighting system / system oświetlenia RGB | 9.10 |
| Vario white lighting system / system oświetlenia Vario white | 9.10 |
| LED profile slings / zawiesia do profili LED | 9.11 |
| tilted bracket for LED profiles / uchwyt uchylny do profili LED | 9.11 |
| cables, extensions, connectors / przewody, przedłużacze, złączki | 9.12 |
| other accessories / pozostałe akcesoria | 9.13 |

general information

informacje ogólne

| | |
|--|------|
| Why LED profiles? / Dlaczego profile LED? | 10.1 |
| LED technology / technologia LED | 10.3 |

sales support

wsparcie sprzedaży

| | |
|---|------|
| Sales support / Wsparcie sprzedaży | 11.1 |
|---|------|



TOPMET LED PROFILES - TUTORIAL
PROFILE LED TOPMET - KROK PO KROKU

2018

LED profiles
profile LED

TOPMET profile categories / Kategorie profili TOPMET



SURFACE / NAWIERZCHNIOWE

LED profiles with the most universal applications. Installation on a flat surface, most commonly with the use of aluminium holders or steel flexible mounting plates but also with the use of screws, or assembly tapes.

It is worth to note the following profiles: SLIM8, SMART10, BEGTON12, SMART16, WIDE24: Slick socket - easy cover assembly. SURFACE10, SURFACE14, LINEA20: hidden mounting.

Profile LED o najbardziej uniwersalnych zastosowaniach. Montaż na płaskiej powierzchni, najczęściej za pomocą uchwytów aluminiowych lub stalowych sprężystych, ale także wkrętów, taśm montażowych.

Warto zwrócić uwagę na profile: SLIM8, SMART10, BEGTON12, SMART16, WIDE24: gniazdo Slick - łatwy montaż klosza. SURFACE10, SURFACE14, LINEA20: ukryte mocowanie.

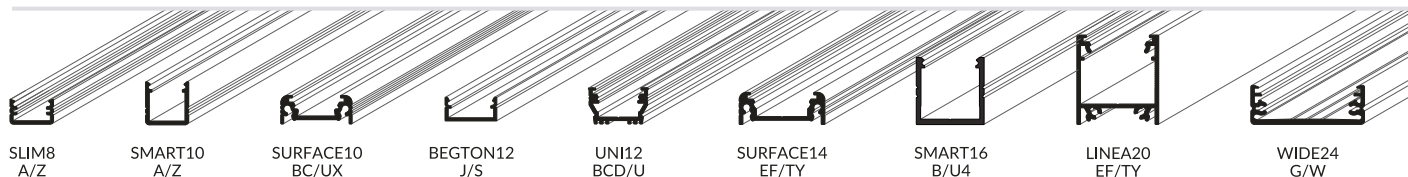

RECESSED / WPUSTOWE

The advantage of embedding a profile is obtaining an illuminating surface which almost levels with the plane of the wall or furniture. Profile installation requires surface preparation - cutting a longitudinal opening in the furniture (HI8, GROOVE10, BEGTIN12, GROOVE14), a plasterboard (FLAT8, DEEP10) or leaving an appropriate distance when installing the tiles (FLOOR12).

Zaletą wpuszczenia profilu jest uzyskanie powierzchni świecącej niemalże licującej się z płaszczyzną ściany lub mebla. Montaż profili wymaga przygotowania powierzchni - wycięcie podłużnego otworu w meblu (HI8, GROOVE10, BEGTIN12, GROOVE14), w płycie gipsowo-kartonowej (FLAT8, DEEP10) lub pozostawienia odpowiedniego dystansu przy montażu płytek (FLOOR12).



CORNER / KĄTOWE

To be used in the corners of wall, furniture and cabinets. Installation with mounting plates, screws, assembly tape. The asset of the CORNER10, CORNER14 and CORNER27 collections is the hidden mounting. These profiles provide a possibility to direct the light at an angle of 30° or 60° to the assembly plane. The CABI12 profile is designed for glass cabinets, then adhesive mounted. It allows to avoid glare. Installation at an angle of 30° or 60°. Thanks to the symmetric cross-section, the profiles can be joined in the corners at an angle of 90°. TRIO10 - for lighting at an angle of 45°.

Do zastosowania w narożnikach ścian, mebli i gablot. Montaż na uchwyty, wkręty, taśmę montażową. Atutem kolekcji CORNER10, CORNER14 i CORNER27 jest ukryte mocowanie. Profile te dają możliwość skierowania światła pod kątem 30° lub 60° do płaszczyzny montażu. Profil CABI12 zaprojektowany do szklanych gablot, montowany na klej. Pozwala uniknąć oślnienia. Montaż pod kątem 30° lub 60°. Dzięki symetrycznemu przekrojowi profile można łączyć w narożnikach pod kątem 90°. TRIO10 - do oświetlania pod kątem 45°.

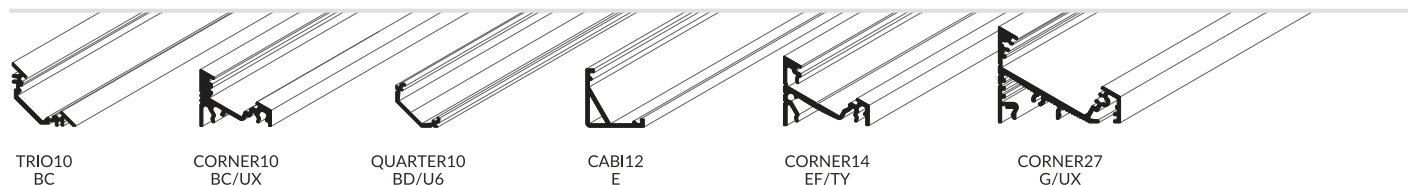



GLASS APPLICATION / DO SZYB

Profiles for glass are used to exhibit objects in cabinets and to illuminate the sanded advertising or decorative graphics. Installed on the edge of the glass panel, they do not constitute a shelf supporting structure. EDGE10 - in contrast to the other ones - is applied on the face of the shelf, which allows to better light up the exhibits under the shelf or above it (after rotating the profile by 180°).

Profile do szyb służy do ekspozycji przedmiotów w gablotach, podświetlają wypisowaną grafikę reklamową lub ozdobną. Montowane na krawędzi szklanej tafli, nie stanowią jednak konstrukcji podtrzymującej półki. EDGE10 – w przeciwieństwie do pozostałych – nakłada się od czoła półki, co pozwala lepiej oświetlić eksponaty pod półką lub nad nią (po obróceniu profilu o 180°).



TWIN8

EDGE10
BC

MIKRO10

MIKRO-LINE12
J



SPECIAL APPLICATION / SPECJALNE

A group of profiles with a broad application spectrum - for the ceiling, wall, architectural, stair, wardrobe. Designed for specialist applications. Among them, the PEN8 with the highest number of holders (i.a.: extension arms, flat, simple and stretcher holders) for creating a number of combinations and achieving the defined illumination effects.

Grupa profili o szerokim spektrum przeznaczenia – ściennie, sufitowe, architektoniczne, schodowe, garderobiane. Zaprojektowane do specjalistycznych zastosowań. Wśród nich PEN8 z największą ilością uchwytów (m.in.: wysięgniki, płaskie, proste, rozporowe) do tworzenia szeregu kombinacji i osiągnięcia określonych efektów świetlnych.

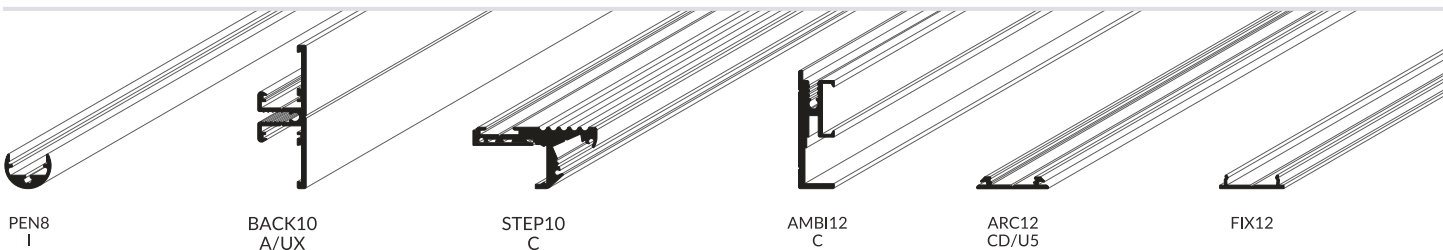

PEN8
I

BACK10
A/UX

STEP10
C

AMBI12
C

ARC12
CD/U5

FIX12

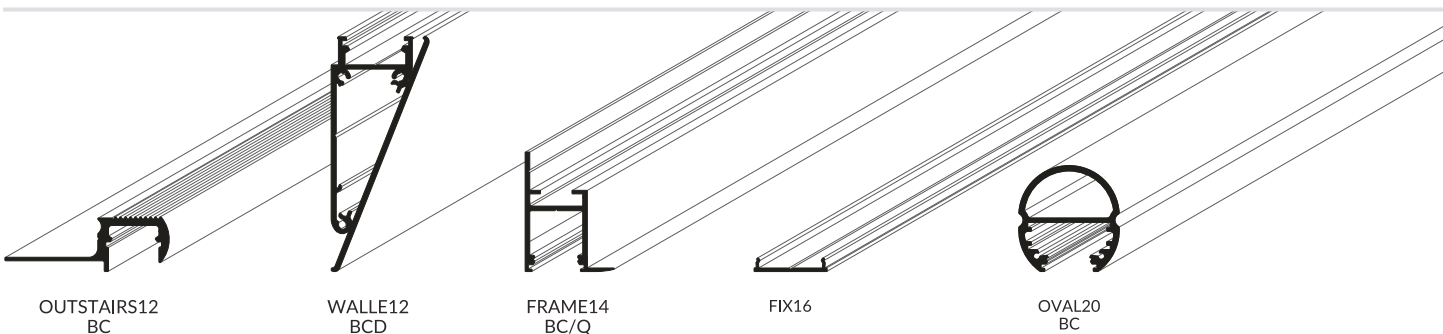

OUTSTAIRS12
BC

WALLE12
BCD

FRAME14
BC/Q

FIX16

OVAL20
BC

What does a profile name indicate? / Co oznacza nazwa profilu?

SURFACE10 BC/UX

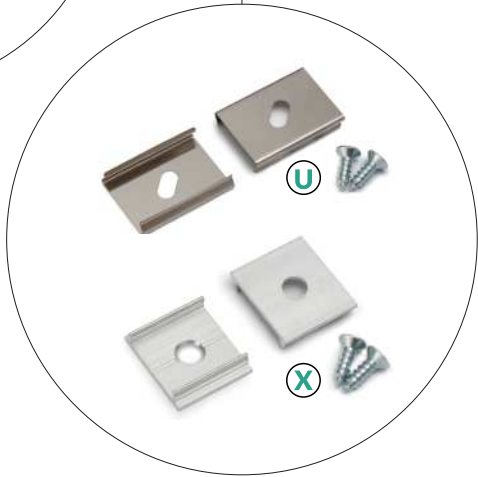
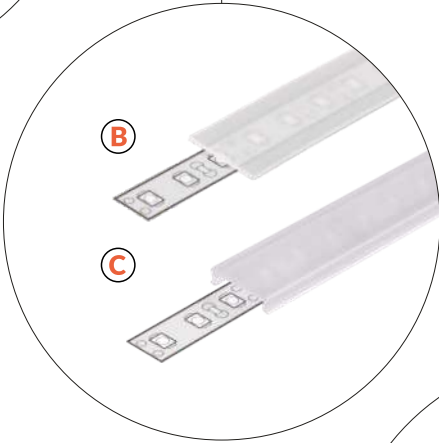

Slick

We also have profiles with the Slick socket in our assortment. This feature allows to click in or slide in the cover.

W naszym asortymencie posiadamy także profile z gniazdem Slick. Funkcja ta pozwala na łatwe „wklikiwanie” lub wsuwanie klosza.

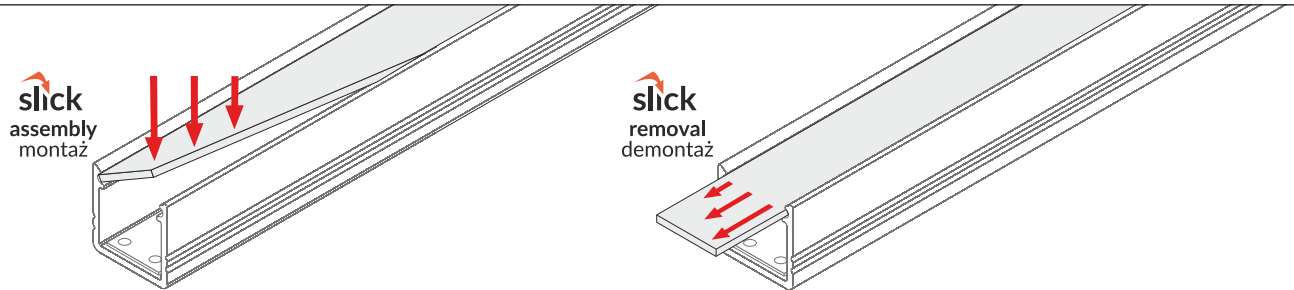

Profiles with Slick socket:

Poniżej profile wyposażone w gniazdo Slick:

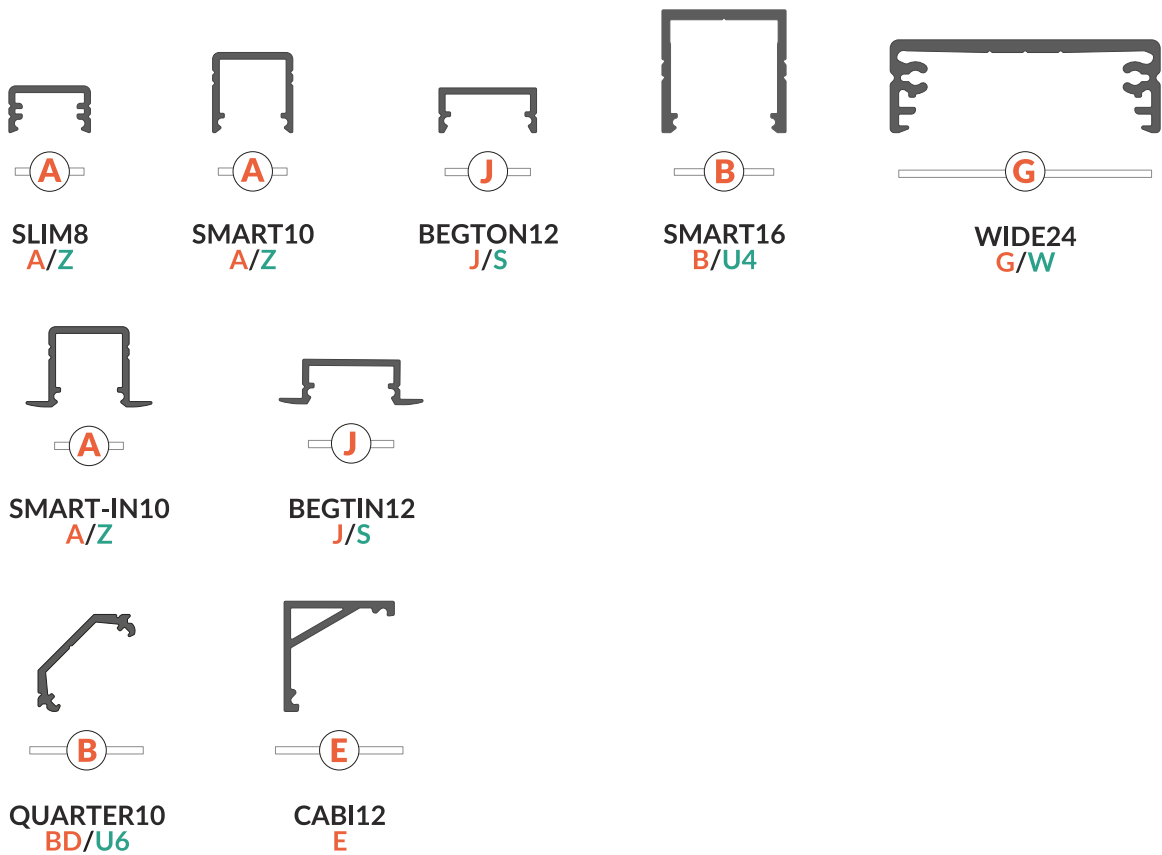

How to select a cover? / Jak dobrać klosz?

Covers for aluminium LED profiles differ in the degree of transparency. Thanks to a conscious choice, you can plan the lighting effect, light dispersion and distribution better. A transparent cover absorbs a smaller amount of light, followed by frosted and white ones.

Klosze do profili aluminiowych LED różnią się stopniem transparentności. Dzięki świadomemu wyborowi można lepiej zaplanować efekt świetlny, rozproszenie i rozsył światła. Klosz transparentny pochłania najmniejszą ilość światła, dalej szron i mleczny.

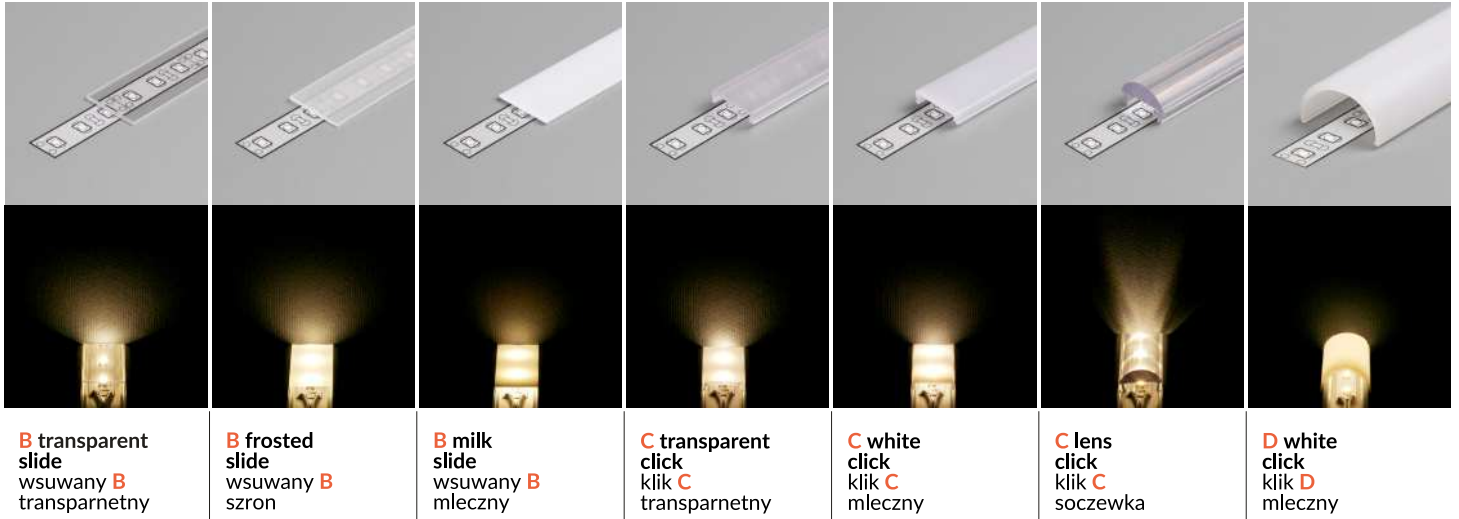

It also means a different degree of visibility of LED points. White covers in some profiles, in conjunction with a 120 P/m tape, allow to achieve the effect of a continuous line of light.

Oznacza to także różny stopień widoczności punktów LED. Klosze mleczne w niektórych profilach w połączeniu z taśmą 120 P/m pozwalają osiągnąć efekt ciągłej linii światła.

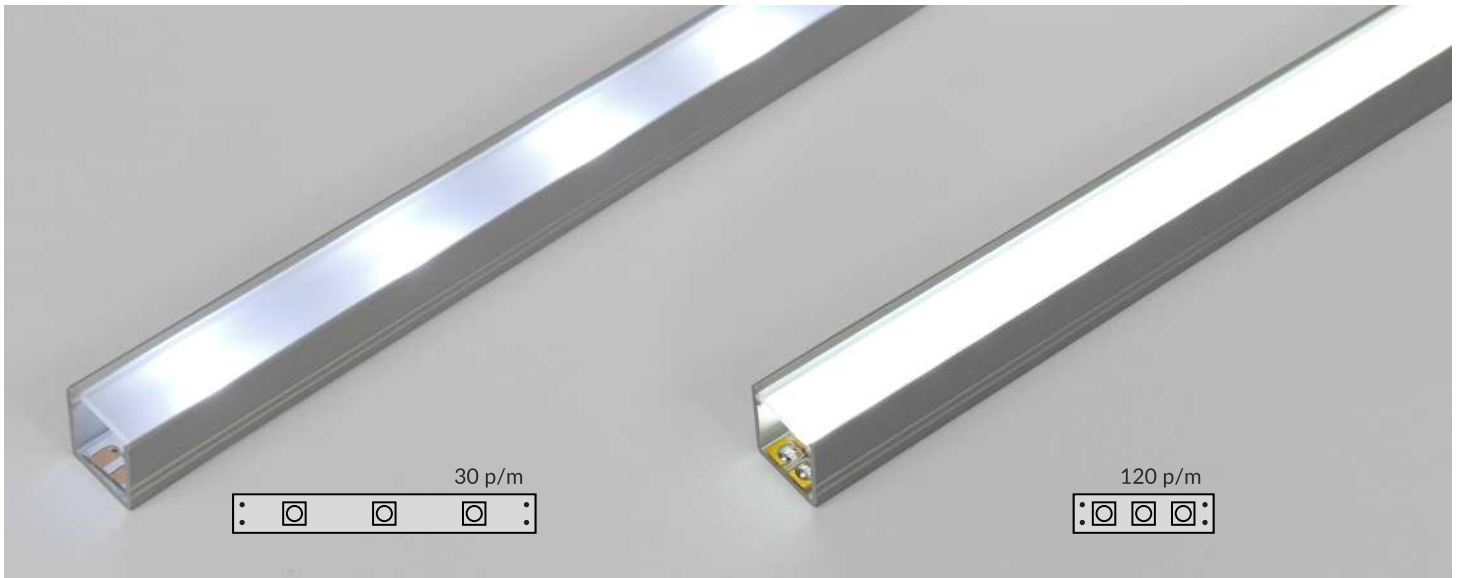

The covers also differ in the method of assembly.

SLIDE COVER (labelling: A, B, E, G, H, J)

It is a strip of plastic available in 3 different degrees of transparency. It needs to be slid from the beginning of the profile and dragged along the marked socket or clicked in the Slick socket.

CLICK COVER (labelling: C, C1, D, F, I, K)

Its assembly and removal are more convenient. Access to the ends of the profile is not necessary, which allows to click in the cover even after installing the profile in a recess or a piece of furniture.

Klosze różnią się także sposobem montażu.

KLOSZ WSUWANY (oznaczenia: A, B, E, G, H, J)

Jest to pasek tworzywa dostępny w 3 różnych stopniach transparentności. Należy go wsunąć od początku profilu i przeciągnąć wzdłuż oznaczonego gniazda lub „wkliknąć” w gniazdo Slick.

KLOSZ KLIK (oznaczenia: C, C1, D, F, I, K)

Jego montaż i demontaż jest wygodniejszy. Dostęp do końców profilu nie jest konieczny, co pozwala wkliknąć klosz nawet po zamontowaniu profilu we wnęce lub w meblu.

Many of the covers in the TOPMET offer are system accessories.
It means that one cover fits a few, different profiles.

A letter describing the socket helps correct matching.

And so, e.g., the SURFACE10 BC/UX profile can be fitted with the covers:

- B slide
- C click
- C lens

Cover C click, on the other hands, fits the profiles:

- SURFACE10 BC/UX
- UNI12 BCD/U
- GROOVE BC/UX
- DEEP10 BC/UX
- TRIO10 BC
- CORNER10 BC/UX
- EDGE10 BC
- STEP10 C
- WALLE12 CD
- AMBI12 C
- ARC12 CD/U5
- OUTSTAIRS12 BC
- FRAME14 BC/Q
- OVAL20 BC

W ofercie TOPMET wiele spośród kloszy to akcesoria systemowe.
Oznacza to, że ten sam klosz pasuje do kilku różnych profili.

W odpowiednim dopasowaniu pomaga litera opisująca gniazdo.

I tak np. do profilu LED SURFACE10 BC/UX pasują klosze:

- B wsuwany
- C klik
- C soczewka

Klosz C klik z kolei pasuje do profili:

- SURFACE10 BC/UX
- UNI12 BCD/U
- GROOVE BC/UX
- DEEP10 BC/UX
- TRIO10 BC
- CORNER10 BC/UX
- EDGE10 BC
- STEP10 C
- WALLE12 CD
- AMBI12 C
- ARC12 CD/U5
- OUTSTAIRS12 BC
- FRAME14 BC/Q
- OVAL20 BC

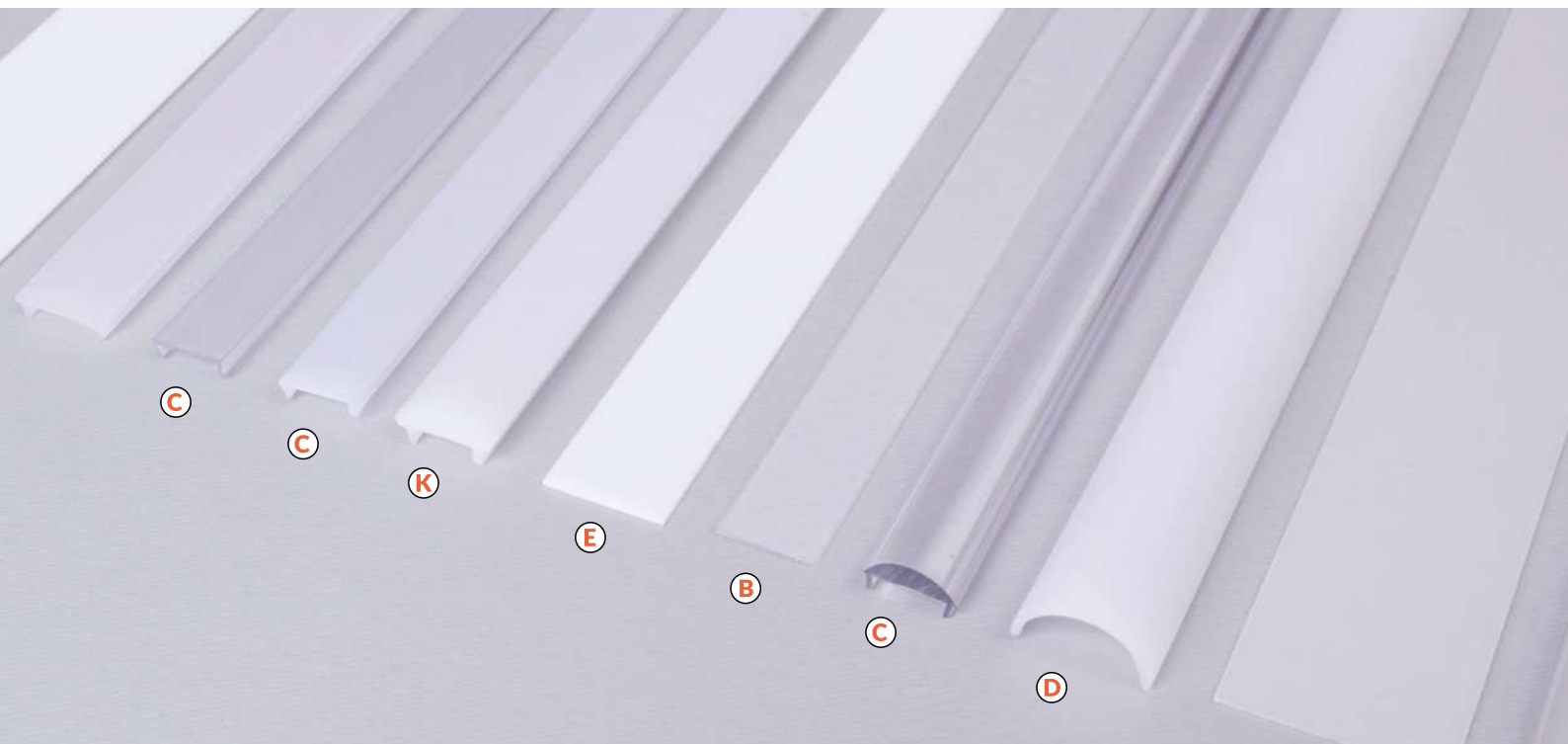

Lengths

Toleration for covers in all lengths: + 20 mm

Długości

Tolerancja dla kloszy we wszystkich długościach: + 20 mm

Covers / Klosze

The covers in the TOPMET offer differ between one another not only in terms of the achieved lighting effect but also in terms of technical parameters. Among the special cover, one stands out in particular - designed for the FLOOR12 LED profile, the K white cover. Its characteristic feature is the high resistance to damage and impacts with a degree of IK 08. This is why it is possible to tread over it - without having to worry about cracking or scratching.

Klosze z oferty TOPMET różnią się między sobą nie tylko uzyskanym efektem świetlnym, ale również parametrami technicznymi. Wśród kloszy specjalnych wyróżnia się zwłaszcza jeden – przeznaczony do profilu LED FLOOR12, czyli klosz K mleczny. Jego cechą charakterystyczną jest wysoka odporność na uszkodzenia oraz udary o stopniu IK 08. Dzięki temu możliwe jest chodzenie po nim - bez obaw o pękanie czy zarysowania.

| cover type rodzaj klosza | material materiał | work temperature temperatura stosowania | | UV resistance odporność na UV | fire hazard certificate according to IEC 60695-2-11 certyfikat na palność wg PN-EN 60695-2-11 | transparency transpa- rentność | coefficient diffusion współczynnik rozproszenia |
|--|----------------------|--|----------|--|---|--------------------------------------|--|
| | | min [°C] | max [°C] | | | | |
| A B E G H transparent transparentny | PC | -50 | 100 | ✓ | ✓ | 93% | low niski |
| A B E G H frosted szron | PP | -15 | 85 | ✓ | ✓ | 90% | low niski |
| A B E G H white mleczny | PP | -15 | 85 | ✓ | ✓ | 70% | high wysoki |
| C transparent transparentny | PMMA | -20 | 70 | ✓ | ✓ | 93% | low niski |
| C white mleczny | PMMA | -20 | 70 | ✓ | ✓ | 75% | low niski |
| C lens soczewka | PC | -50 | 100 | ✓ | ✓ | 90% | low niski |
| D white mleczny | PMMA | -20 | 70 | ✓ | ✓ | 70% | high wysoki |
| F transparent transparentny | PMMA | -20 | 70 | ✓ | ✓ | 93% | low niski |
| F white mleczny | PMMA | -20 | 70 | ✓ | ✓ | 75% | medium średni |
| I frosted szron | PC | -50 | 100 | ✓ | ✓ | 90% | low niski |
| I white mleczny | PC | -50 | 100 | ✓ | ✓ | 80% | medium średni |
| K white mleczny | PC | -50 | 100 | ✓ | ✓ | 60% | high wysoki |

Endings / Zaślepki

The endings, with the aim to aesthetically close the profile and additionally protect the LED source, come in four basic colours: silver, white, black and grey. The endings selected for the profiles for glass are available in transparent colour.

The material used for the production of the endings meets the lighting non-combustibility standard no.: PN-EN 60695-2-11. Material: ABS, PC.

Zaślepki, mające na celu estetyczne domknięcie profilu oraz dodatkową ochronę źródła LED, występują w czterech podstawowych kolorach: srebrnym, białym, czarnym i szarym. Wybrane zaślepki do profili do szyb dostępne są w kolorze transparentnym.

Tworzywo użyte do produkcji zaślepek spełnia oświetleniową normę niepalności nr: PN-EN 60695-2-11. Materiał: ABS, PC.



Endings with a hole or without it - which one to choose? Many of our endings come in two versions:

Zaślepki z otworem czy bez - jakie wybrać? Wiele spośród naszych zaślepek występuje w dwóch wersjach:



With a hole: they allow aesthetic outlet for a cable without the need to drill through the ending or the profile.

Z otworem: pozwalają na estetyczne wyprowadzenie przewodu bez konieczności przewiercania zaślepki lub profilu.



Without a hole: they are an aesthetic and a tighter ending of the profile. Recommended in cases where the appearance is particularly significant, or from the opposite side to the cable outlet.

Bez otworu: stanowią estetyczne i szczelniejsze zakończenie profilu. Zalecane tam, gdzie szczególnie istotny jest wygląd lub od strony przeciwnej niż wyprowadzenie przewodu.

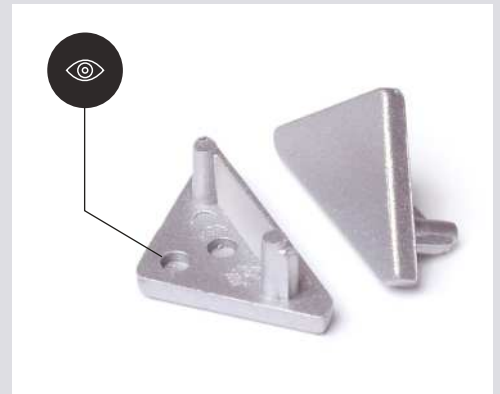

For new products, we offer endings with points to bore a hole. Thanks to this, from one set of endings, it is possible to obtain one ending of each type: with a hole and without one. They are available for the profiles: ARC12, BEGTON12, CABI12, LINEA20, QUARTER10, TRIO10.

Do nowych produktów oferujemy zaślepki z punktami do nawiercenia otworu. Dzięki temu z jednego kompletu zaślepek możliwe jest otrzymanie po jednej zaślepce: z otworem oraz bez otworu. Są one dostępne dla profili: ARC12, BEGTON12, CABI12, LINEA20, QUARTER10, TRIO10.

Mounting accessories / Akcesoria montażowe

SYSTEM ACCESSORIES – fit many different profiles.

DEDICATED ACCESSORIES - matched to one profile, are usually used for a more precise assembly method: pendant, on an extension arm, at an angle, etc.

AKCESORIA SYSTEMOWE – pasują do wielu różnych profili.

AKCESORIA DEDYKOWANE - dopasowane do jednego profilu, zwykle służą do bardziej sprecyzowanego rodzaju montażu: podwieszanego, na wysięgniku, pod kątem itp.

MOUNTING PLATES, HOLDERS / UCHWYTY

flexible / sprężyste



U flexible mounting plate
uchwyt U sprężysty



cone U flexible mounting plate
uchwyt U sprężysty cone



rack U flexible mounting plate
uchwyt U sprężysty rack

aluminium / aluminiowe



X mounting plate
uchwyt X



T mounting plate
uchwyt T

simple - for perpendicular assembly in a furniture board (cabinets)

proste - do montażu prostokątnego w płycie meblowej (szafki)



SLIM8 simple holder
uchwyt SLIM8 prosty



SURFACE10 simple holder
uchwyt SURFACE10 prosty



WIDE24 simple holder
uchwyt WIDE24 prosty



PEN8 simple holder
uchwyt PEN8 prosty



OVAL20 simple holder
uchwyt OVAL20 prosty

„cone” or „slot”?
„cone” czy „fasolka”?

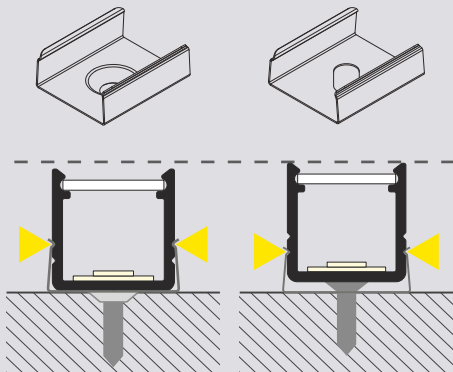

EXTENSION ARMS / WYSIĘGNIKI



OVAL20 double extension arm
wysięgnik OVAL20 podwójny



PEN8 double holder with thread
uchwyt PEN8 podwójny z gwintem



PEN8 jointed holder with soffit ceiling
uchwyt PEN8 przegubowy z podsufitką

CONNECTORS / ŁĄCZNIKI

Easy method of joining 2 profile sections in a straight line or at a defined angle.
Łatwy sposób na łączenie 2 odcinków profili w linii prostej lub pod określonym kątem.



X connector 180 deg
łącznik X 180 st



SURFACE10 connector 90 deg
łącznik SURFACE10 90 st



LINEA20 connectors / łączniki LINEA20:

60°

90°

120°

135°

180°



T connector 180 deg
łącznik T 180 st



GROOVE10 connector 90 deg
łącznik GROOVE10 90 st

LINEA20 bent connectors / łączniki LINEA20 gięte:

90°

270°



CORNER10 connector 90 deg
łącznik CORNER10 90 st

SLINGS / ZAWIESIA

They enable creating pendant luminaires. They are especially recommended for the LED LINEA 20 profile (see pages 2.27-2.28) but are also compatible with most of the profiles.

Umożliwiają tworzenie opraw wiszących. Szczególnie polecane są do profilu LED LINEA20 (patrz str. 2.27-2.28), ale kompatybilne są także z większością profili.

50 V



SELV sling 50V 1500
zawiesie SELV 50V 1500



sling for LED mounting 1500
zawiesie do uchwytu LED 1500



LED accessories / Akcesoria LED

Different LED sources and electronic components can be used for aluminium LED profiles. The correct sequence of connecting individual elements is very important.

Do aluminiowych profili LED można stosować różne źródła LED oraz elektroniczne komponenty. Bardzo istotna jest właściwa kolejność połączenia poszczególnych elementów.

Source / Źródło



We have LED strips with different power, luminous flux and width to choose from. We also have strips available with different light colour temperatures - a few different temperatures of white and primary colours, as well as RGB and warm-cold with adjustable light colour temperature). The most commonly used sources are the ones for the 12 V voltage but sources for the 24 V voltage are also available. Apart from the most popular LED strips available on the market, there are also LED modules on a rigid surface. They are usually characterized by better light parameters and quality. Waterproof sources and components are a special part of the offer.

Depending on the LED selection, you need to match the remaining accessories: cables, connectors, switches, controllers and power supplies.

Some LED sources available on the market may exceed radiation capabilities of a given aluminium profile. In order to ensure correct operation, a LED source with appropriate parameters needs to be matched to an aluminium profile.

LED cable • connectors • distribution box Przewód LED • złączki • konektor



In the case of connecting a few sources to one power supply, you can use a connector for mini-connector with 6 sockets or a LED divider. Our offer also includes cables of different lengths for one colour of LED strips, as well as special ones for RGB strips and separately, for waterproof strips.

Switch • controller / Włącznik • sterownik



A lighting fixture set can be enriched with different types of convenient solutions regarding switching, dimming and change of colour. Mechanical switches are available - integrated with the cable or for connecting directly to the LED source, under the cover inside the profile. Turning on is possible both by touch, as well as radio waves - with a remote control via a controller. You can control the colour (with an appropriate light source selected) as well as illuminance.

12 V or 24 V power supply Zasilacz 12 V lub 24 V

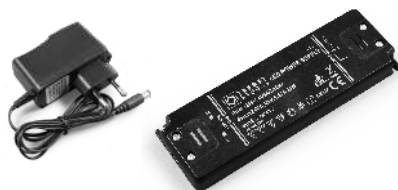

12 V

or / lub

24 V

The selection of the power supply requires calculation of the power to be consumed by the source, according to the indications of the manufacturer. From the primary side, the current has a voltage of 220-240 V, on the secondary side, to which the LED is connected, the voltage is 12 V or 24 V.

220-240 V cable / Przewód 220-240 V



220
-240V

220 - 240 V cables, which allow the connection of an entire set to the power supply are also in our offer. A standard cable is 4 m long and a cable with a foot switch - 3.5 m.

More details are available in the LED accessories catalogue (pages: 9.2-9.13).

Do wyboru mamy taśmy LED'owe o różnej mocy, strumieniu świetlnym i szerokości. Dostępne są również taśmy o różnej temperaturze barwowej światła – kilka różnych temperatur bieli oraz podstawowe kolory, a także RGB oraz ciepła-zimna z możliwością zmiany temperatury barwowej światła). Najpowszechniej stosowane są źródła dostosowane do napięcia 12 V, ale dostępne są również źródła na 24 V. Poza dostępnymi na rynku najpopularniejszymi taśmami LED istnieją również moduły LED'owe na sztywnym podłożu. Zazwyczaj charakteryzują się znacznie lepszymi parametrami i jakością światła. Specjalną częścią oferty są źródła i komponenty wodoodporne.

Według wybranego źródła LED należy dobierać pozostałe akcesoria: przewody, złączki, włączniki, sterowniki oraz zasilacze.

Niektóre źródła LED dostępne na rynku mogą przekraczać radiacyjne możliwości wybranego profilu aluminiowego. W celu zapewnienia poprawnego działania, należy dobrać do profilu aluminiowego źródło LED o odpowiednich parametrach.

W przypadku podłączenia kilku źródeł do jednego zasilacza, można użyć konektora do mini-złączek z 6 gniazdami lub rozdzielacza LED. Nasza oferta obejmuje także przewody o różnej długości, do jednego koloru taśm LED, a także specjalne do taśm RGB i osobno do taśm wodoodpornych.

Zestaw oświetleniowy można wzbogacić o różnego rodzaju wygodne rozwiązania włączania, ściemniania oraz zmiany koloru. Dostępne są włączniki mechaniczne – zintegrowane z przewodem lub do podłączenia bezpośrednio do źródła LED pod kłosem wewnątrz profilu. Włączanie możliwe jest zarówno przez dotyk, jak i przez fale radiowe – pilotem za pośrednictwem sterownika. Sterować można zarówno barwę (przy wyborze odpowiedniego źródła) oraz natężenie światła.

Dobór zasilacza wymaga przeliczenia mocy, jaką będzie pobierać źródło według wskazań producenta. Od strony pierwotnej prąd ma napięcie 220-240 V, po stronie wtórnej, do której podłączamy LED, napięcie wynosi 12 V lub 24 V.

W naszej ofercie są także przewody 220 – 240 V pozwalające podłączyć cały zestaw do zasilania. Standardowy przewód ma długość 4 m, przewód z włącznikiem nożnym – 3,5 m.

Więcej szczegółów dostępnych jest w katalogu akcesoriów LED (str.: 9.2-9.13).





SURFACE
NAWIERZCHNIOWE

2018

LED profiles
profile LED

SMALL, ALUMINIUM, SURFACE PROFILE

MAŁY, ALUMINIOWY PROFIL NAWIERZCHNIOWY

- decorative lighting profile
- universal application
- Slick socket
- 2 channels for mounting bracket (with or without wall distance)
- painted holders
- maximum LED strip width: 8 mm
- profil dekoracyjno-oświetleniowy
- uniwersalne zastosowanie
- gniazdo Slick
- 2 rowki - 2 poziomy przymocowania uchwyty (z dystansem od ściany lub bez)
- malowane uchwyty
- maksymalna szerokość taśmy LED: 8 mm

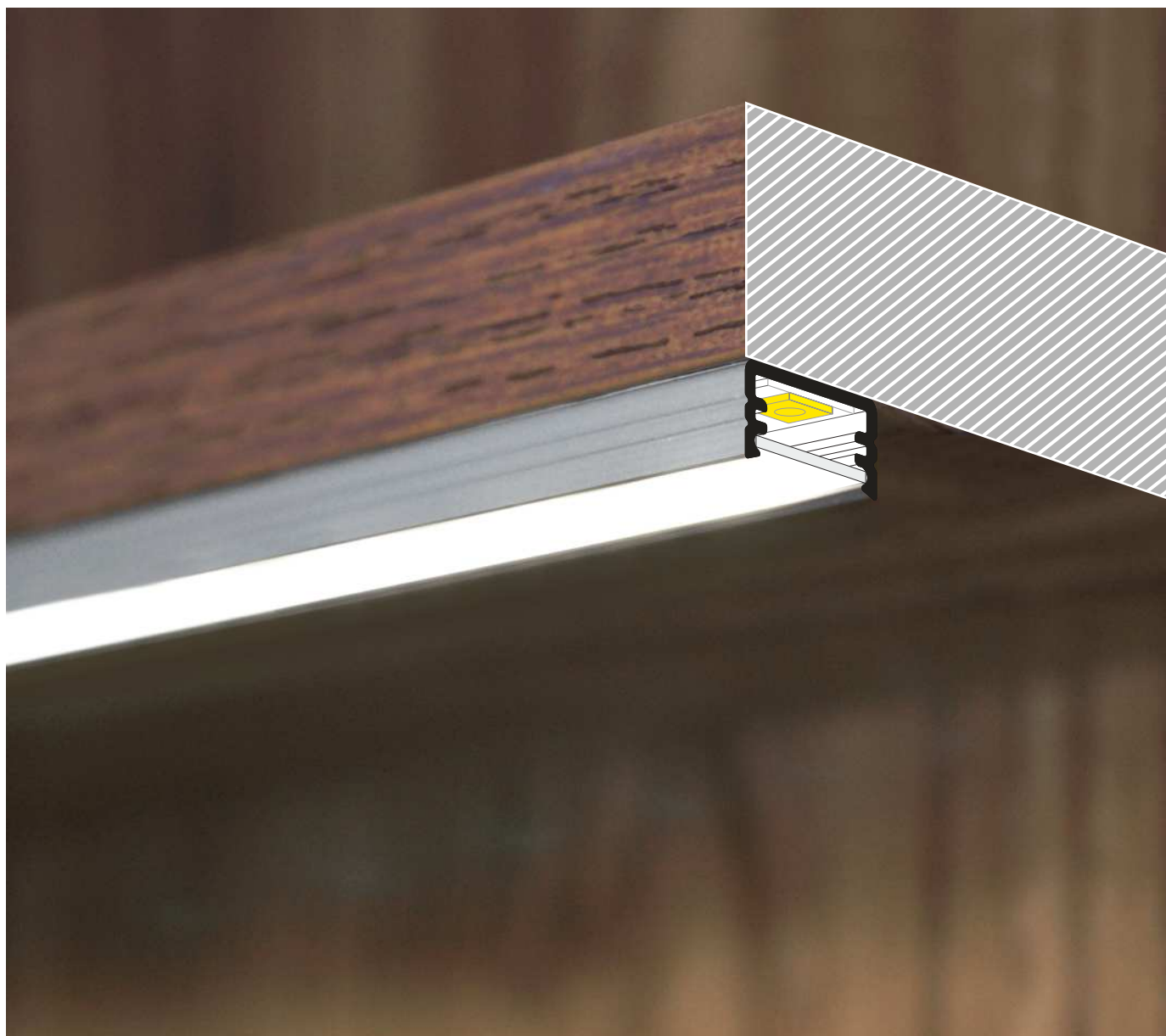

SIMILAR IN THE OFFER / PODOBNE W OFERCIE





A slide cover
klosz A wsuwany

Z¹ Z flexible mounting plate
uchwyt Z sprężysty

Z² cone Z flexible mounting plate
uchwyt Z sprężysty cone

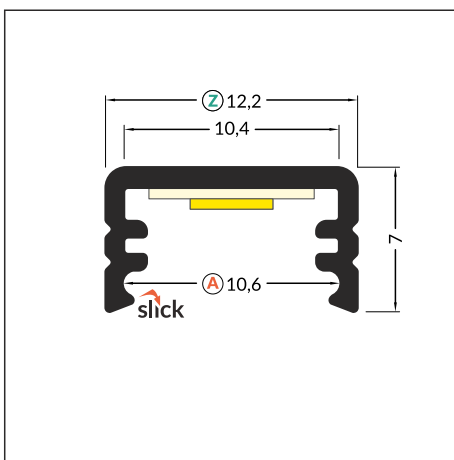
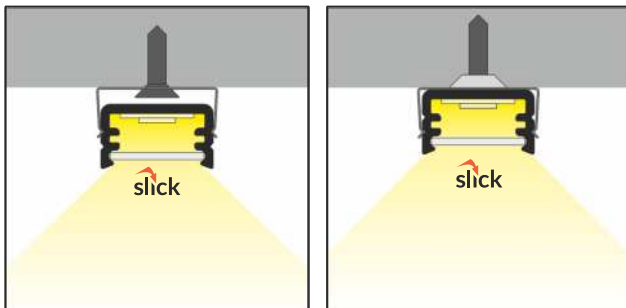
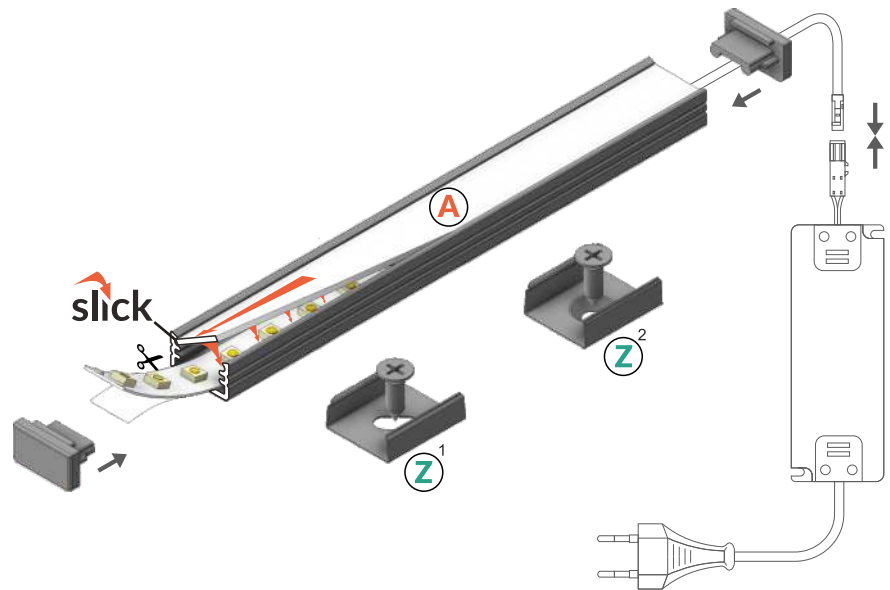

 max 8 mm

 surface
nawierzchniowy



INDEX = 1 pc, length 2000 mm
package = 10 pcs
INDEKS = 1 szt., długość 2000 mm
opakowanie = 10 szt.

 white painted
biały malowany
89030001

 anodized
anodowany
89030020

 black anodized
czarny anodowany
89030021

 raw aluminium
surowe aluminium
89030000

Available lengths / Dostępne długości
1000 mm, 2000 mm, 3000 mm, 4000 mm



COVERS / KLOSZE

A slide cover
colours: transparent, frosted, white
material: PC, PP, PP

klosz **A** wsuwany
kolory: transparentny, szron, mleczny
materiał: PC, PP, PP

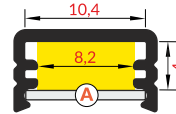
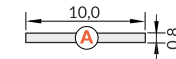

Note! Dimensions of the space
to install LED source
Uwaga! Wymiary przestrzeni
do zamontowania źródła LED

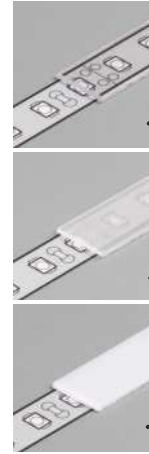

INDEX = 1 pc, length 2000 mm
package = 10 pcs
INDEKS = 1 szt., długość 2000 mm
opakowanie = 10 szt.

A transparent / A transparentny
89070016

A frosted / A szron
89070039

A white / A mleczny
89070038

ENDINGS / ZAŚLEPKI

SLIM8 ending
colours: white, silver, black, grey
material: ABS

zaślepka SLIM8
kolory: biały, srebrny, czarny, szary
materiał: ABS

SLIM8 ending with hole
colours: white, silver, black, grey
material: ABS

zaślepka SLIM8 z otworem
kolory: biały, srebrny, czarny, szary
materiał: ABS

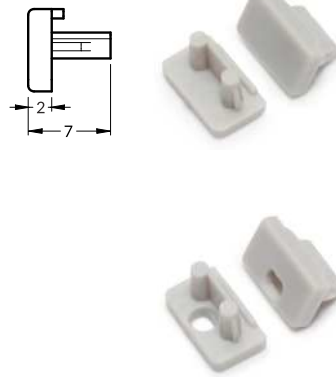
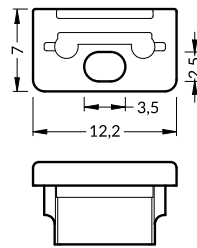

INDEX = 1 set
package of 10 sets = 20 pcs
INDEKS = 1 komplet, opakowanie
zawiera 10 kompletów = 20 szt.

white / białe
with hole z otworem 89140001 | without hole bez otworu 89080001

silver / srebrne
with hole z otworem 89140040 | without hole bez otworu 89080040

black / czarne
with hole z otworem 89140002 | without hole bez otworu 89080002

grey / szare
with hole z otworem 89140022 | without hole bez otworu 89080022

MOUNTINGS / MOCOWANIA

Z flexible mounting plate
colours: white, inox, black
material: stainless steel

uchwyt **Z** sprężysty
kolory: biały, inox, czarny
materiał: stal nierdzewna

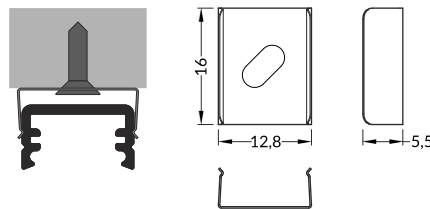

INDEX = 1 set
package of 10 sets = 20 pcs
INDEKS = 1 komplet
opakowanie zawiera 10 kpl = 20 szt.

Z flexible mounting plate
uchwyt **Z** sprężysty

white biały 89270001

inox inox 89270019

black czarny 89270002

cone Z flexible mounting plate
colours: white, inox, black
material: stainless steel

uchwyt **Z** sprężysty cone
kolory: biały, inox, czarny
materiał: stal nierdzewna

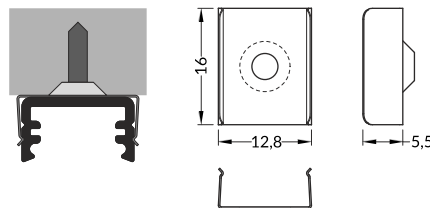

cone Z flexible mounting plate
uchwyt **Z** sprężysty cone

white biały 89980001

inox inox 89980019

black czarny 89980002

SLIM8 simple holder
material: zinc coated steel

uchwyt SLIM8 prosty
materiał: stal ocynkowana

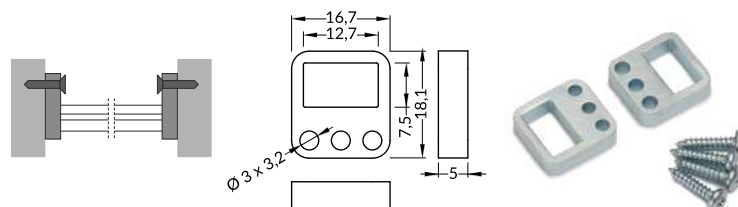

INDEX = 1 set = 2 pcs
INDEKS = 1 komplet = 2 szt.

simple holder
uchwyt prosty

zinc coated
stal ocynkowana
89110030



CONNECTORS / ŁĄCZNIKI

SLIM8 connector 90 deg
colours: white, anodized, black
material: aluminium

łącznik SLIM8 90 st
kolory: biały, anodowany, czarny
materiał: aluminium

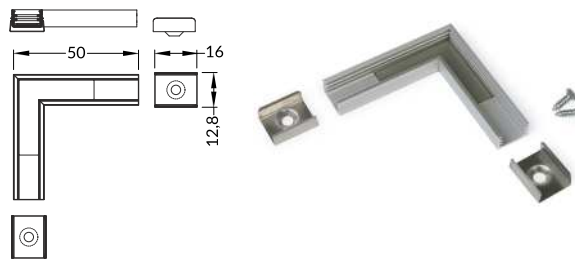

INDEX = 1 set
INDEKS = 1 komplet

-  white painted
biały malowany
89150001
-  anodized
anodowany
89150020
-  black anodized
czarny anodowany
89150021



CONTINUOUS LINE OF LIGHT IN A SMALL OVERALL DIMENSIONS

CIĄGŁA LINIA ŚWIATŁA W MAŁYM GABARYCIE

- decorative and lighting profile
- continuous line of light (when using LED strip 120 P/m and white cover)
- SLICK socket
- miniature dimensions
- universal application
- the possibility of using waterproof LED strips
- maximum width of LED strip: 10 mm

- profil dekoracyjno-oświetleniowy
- ciągła linia światła (przy zastosowaniu taśmy 120 P/m i klosza mlecznego)
- gniazdo SLICK
- miniaturowe gabaryty
- uniwersalne zastosowanie
- możliwość zastosowania taśm wodoodpornych
- maksymalna szerokość taśmy LED: 10 mm



SIMILAR IN THE OFFER / PODOBNE W OFERCIE



SLIM8
A/Z



SMART-IN10
A/Z



SURFACE10
BC/UX



BEGTON12
J/S



SURFACE14
EF/TY



A slide cover
klosz A wsuwany

Z¹ Z flexible mounting plate
uchwyt Z sprężysty

Z² cone Z flexible mounting plate
uchwyt Z sprężysty cone

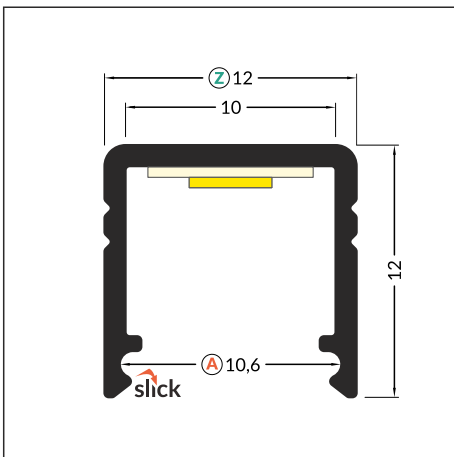
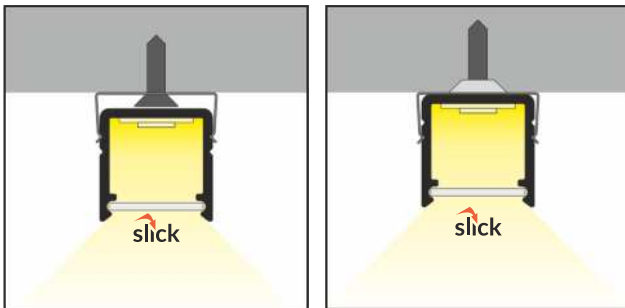
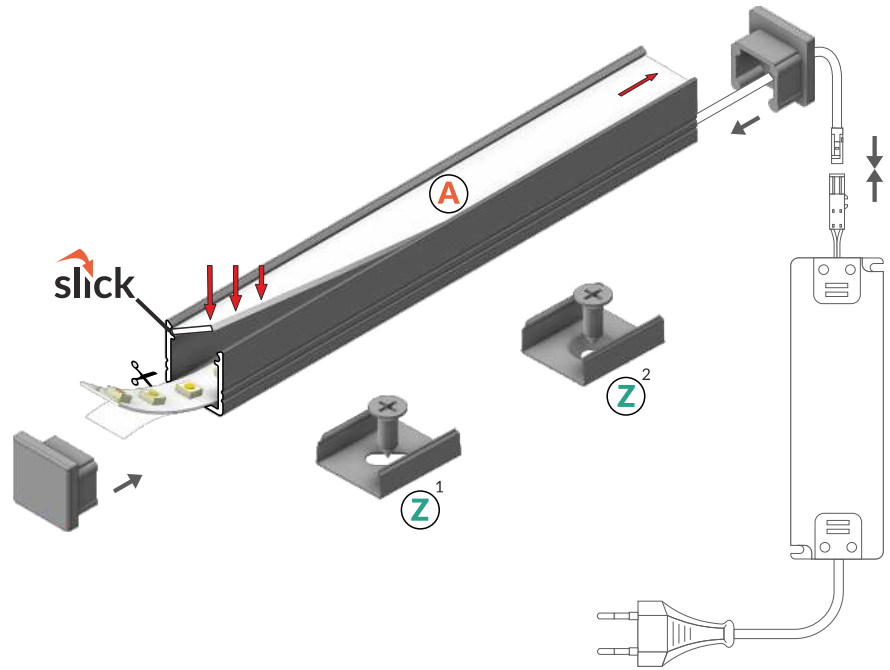

max 10 mm

surface
nawierzchniowy



INDEX = 1 pc, length 2000 mm
package = 10 pcs
INDEKS = 1 szt., długość 2000 mm
opakowanie = 10 szt.

white painted
biały malowany
C2020001



anodized
anodowany
C2020020



black anodized
czarny anodowany
C2020021



raw aluminium
surowe aluminium
C2020000

Available lengths / Dostępne długości
1000 mm, 2000 mm, 3000 mm, 4000 mm



COVERS / KLOSZE

A slide cover
colours: transparent, frosted, white
material: PC, PP, PP

klosz **A** wsuwany
kolory: transparentny, szron, mleczny
materiał: PC, PP, PP



Note! Dimensions of the space to install LED source
Uwaga! Wymiary przestrzeni do zamontowania źródła LED

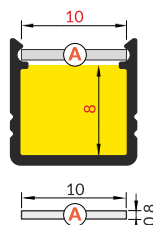

INDEX = 1 pc, length 2000 mm
package = 10 pcs
INDEKS = 1 szt., długość 2000 mm
opakowanie = 10 szt.

A transparent / A transparentny
89070016

A frosted / A szron
89070039

A white / A mleczny
89070038

ENDINGS / ZAŚLEPKI

SMART10 ending
colours: white, silver, black, grey
material: ABS

zaślepka SMART10
kolory: biały, srebrny, czarny, szary
materiał: ABS

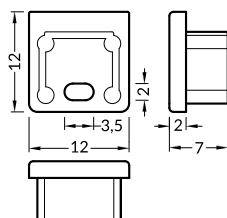

SMART10 ending with hole
colours: white, silver, black, grey
material: ABS

zaślepka SMART10 z otworem
kolory: biały, srebrny, czarny, szary
materiał: ABS

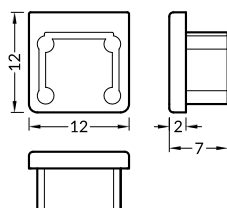

INDEX = 1 set
package of 10 sets = 20 pcs
INDEKS = 1 komplet, opakowanie
zawiera 10 kompletów = 20 szt.

white / białe
without hole bez otworu | with hole z otworem
C2940001 | C2960001

silver / srebrne
without hole bez otworu | with hole z otworem
C2940040 | C2960040

black / czarne
without hole bez otworu | with hole z otworem
C2940002 | C2960002

grey / szare
without hole bez otworu | with hole z otworem
C2940022 | C2960022

MOUNTINGS / MOCOWANIA

Z flexible mounting plate
colours: white, inox, black
material: stainless steel

uchwyt **Z** sprężysty
kolory: biały, inox, czarny
materiał: stal nierdzewna

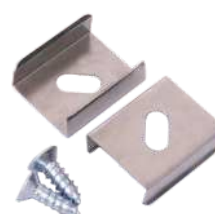
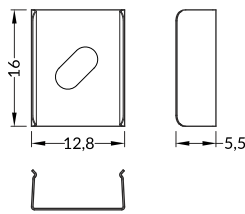
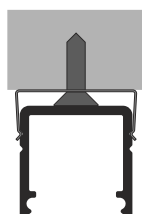

INDEX = 1 set
package of 10 sets = 20 pcs
INDEKS = 1 komplet
opakowanie zawiera 10 kpl = 20 szt.

Z flexible mounting plate
uchwyt **Z** sprężysty

white biały 89270001

inox inox 89270019

black czarny 89270002

cone Z flexible mounting plate
colours: white, inox, black
material: stainless steel

uchwyt **Z** sprężysty cone
kolory: biały, inox, czarny
materiał: stal nierdzewna

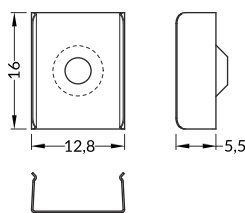
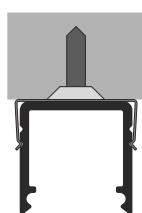

cone Z flexible mounting plate
uchwyt **Z** sprężysty cone

white biały 89980001

inox inox 89980019

black czarny 89980002



CONNECTORS / ŁĄCZNIKI

SMART10 connector 90 deg
colours: white, anodized, black
material: aluminium

łącznik SMART10 90 st
kolory: biały, anodowany, czarny
materiał: aluminium

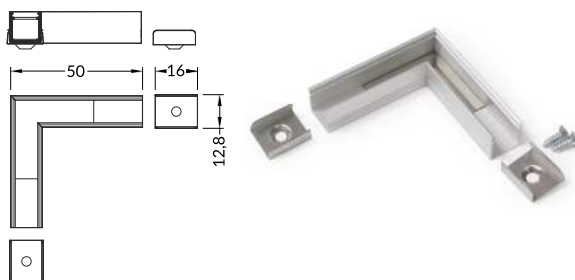

INDEX = 1 set
INDEKS = 1 komplet

-  white painted
biały malowany
C2910001
-  anodized
anodowany
C2910020
-  black anodized
czarny anodowany
C2910021



SURFACE10 BC/UX

ALUMINIUM SURFACE PROFILE

ALUMINIOWY PROFIL NAWIERZCHNIOWY

- hidden mounting
- decorative and lighting profile
- wide range of accessories, 6 types of covers
- maximum LED strip width: 10 mm
- ukryte mocowanie
- profil dekoracyjno oświetleniowy
- szeroki wybór akcesoriów, 6 rodzajów kloszy
- maksymalna szerokość taśmy LED: 10 mm

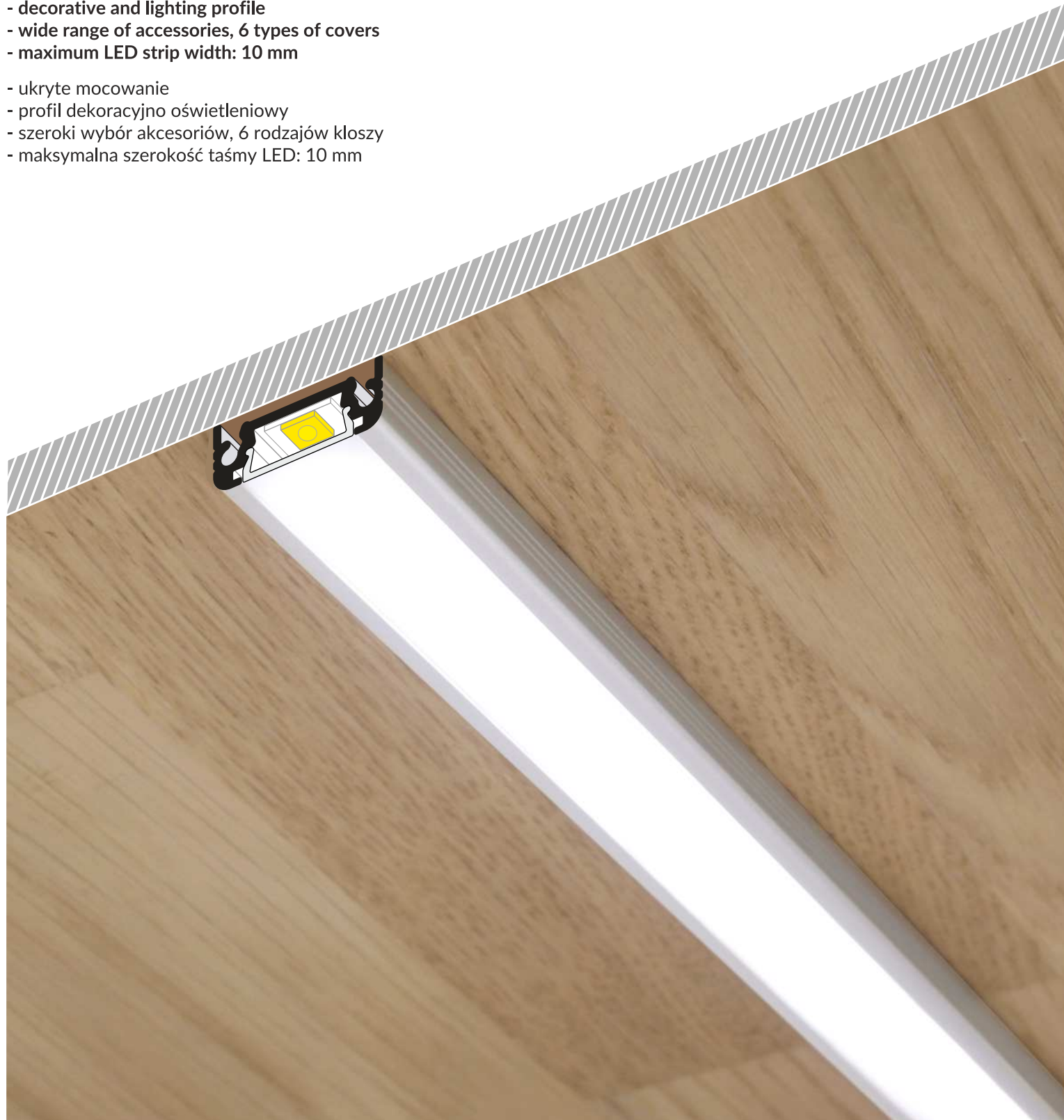

SIMILAR IN THE OFFER / PODOBNE W OFERCIE



SLIM8
A/Z



SMART10
A/Z



BEGTON12
J/S



SURFACE14
EF/TY



LINEA20
EF/TY



WIDE24
G/W



B slide cover
klosz B wsuwany

C click cover
klosz C klik

C lens cover
klosz C soczewka

U¹ flexible mounting plate
uchwyt U sprężysty

U² cone U flexible mounting plate
uchwyt U sprężysty cone

X¹ mounting plate
uchwyt X

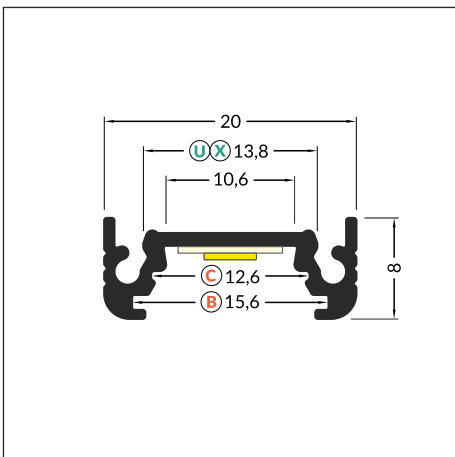
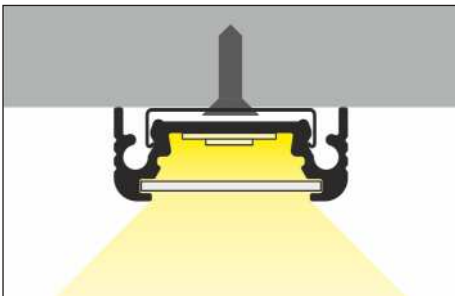
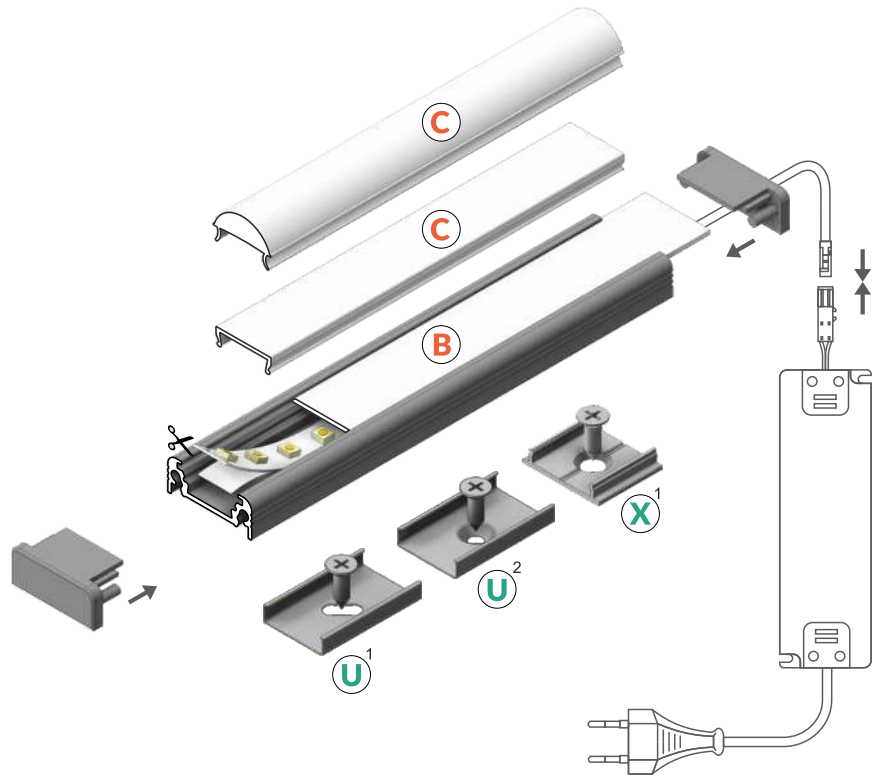

 max 10 mm

 surface
nawierzchniowy



INDEX = 1 pc, length 2000 mm
package = 10 pcs
INDEKS = 1 szt., długość 2000 mm
opakowanie = 10 szt.

 white painted
biały malowany
77270001



 anodized
anodowany
77270020



 black anodized
czarny anodowany
77270021



 raw aluminium
surowe aluminium
77270000

Available lengths / Dostępne długości
1000 mm, 2000 mm, 3000 mm, 4000 mm



COVERS / KLOSZE

B slide cover
colours: transparent, frosted, white
material: PC, PP, PP

klosz **B** wsuwany
kolory: transparentny, szron, mleczny
materiał: PC, PP, PP

C click cover
colours: transparent, white
material: PMMA

klosz **C** klik
kolory: transparentny, mleczny
materiał: PMMA

C click cover lens
colour: transparent
material: PC

klosz **C** klik soczewka
kolor: transparentny
materiał: PC



Note! Dimensions of the space to install LED source
Uwaga! Wymiary przestrzeni do zamontowania źródła LED

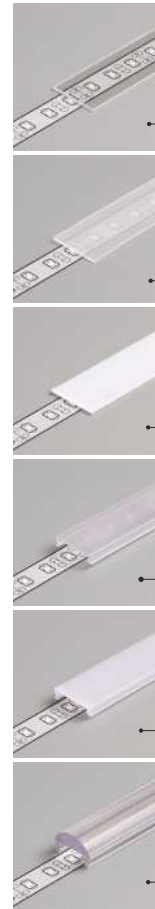
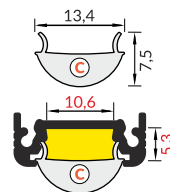
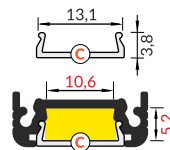
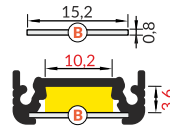

INDEX = 1 pc, length 2000 mm
package = 10 pcs
INDEKS = 1 szt., długość 2000 mm
opakowanie = 10 szt.

B transparent / B transparentny
76250016

B frosted / B szron
76250039

B white / B mleczny
76250038

C transparent / C transparentny
76330000

C white / C mleczny
76330038

C lens / C soczewka
76300000

MOUNTINGS / MOCOWANIA

U flexible mounting plate
colours: inox
material: stainless steel

uchwyt **U** sprężysty
kolory: inox
materiał: stal nierdzewna

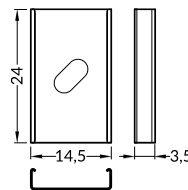
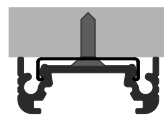

INDEX = 1 set
package of 10 sets = 20 pcs
INDEKS = 1 komplet
opakowanie zawiera 10 kpl = 20 szt

U flexible mounting plate
uchwyt **U** sprężysty

inox 76380000

cone U flexible mounting plate
colours: inox
material: stainless steel

uchwyt **U** sprężysty cone
kolory: inox
materiał: stal nierdzewna

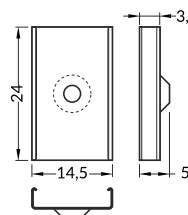
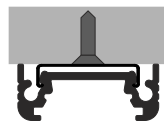

cone U flexible mounting plate
uchwyt **U** sprężysty cone

inox 76620000

X mounting plate
colours: raw aluminium
material: aluminium

uchwyt **X**
kolory: surowe aluminium
materiał: aluminium

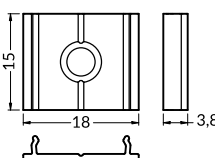
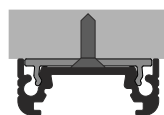

X mounting plate
uchwyt **X**

raw aluminium
surowe aluminium
76260000

SURFACE10 simple holder
material: zinc coated

uchwyt SURFACE10 prosty
materiał: stal ocynkowana

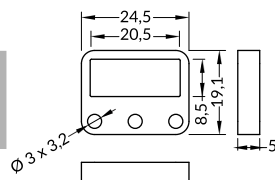
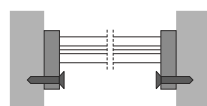

INDEX = 1 set = 2 pcs
INDEKS = 1 komplet = 2 szt.

simple holder
uchwyt prosty

zinc coated
stal ocynkowana
77370030



ENDINGS / ZAŚLEPKI

endings SURFACE10
colours: white, silver, black, grey
material: ABS
zaślepka SURFACE10 bez otworu
kolory: biały, srebro, czarny, szary
materiał: ABS

endings SURFACE10 with hole
colours: white, silver, black, grey
material: ABS
zaślepka SURFACE10 z otworem
kolory: biały, srebro, czarny, szary
materiał: ABS

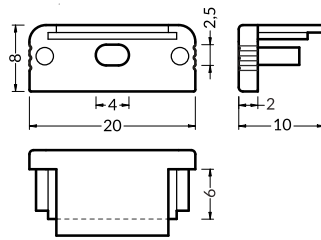

INDEX = 1 set
package of 10 sets = 20 pcs
INDEKS = 1 komplet, opakowanie
zawiera 10 kompletów = 20 szt.

| | | |
|--|------------------------------------|--|
|  white białe | with hole z otworem 77520001 | without hole bez otworu 77280001 |
|  silver srebro | with hole z otworem 77520040 | without hole bez otworu 77280040 |
|  black czarne | with hole z otworem 77520002 | without hole bez otworu 77280002 |
|  grey szare | with hole z otworem 77520022 | without hole bez otworu 77280022 |

CONNECTORS / ŁĄCZNIKI

X connector 180 deg
colour: inox
material: aluminium
łącznik X 180 st
kolor: inox
materiał: aluminium

SURFACE10 connector 90 deg
colours: white, anodized, black
material: aluminium
łącznik SURFACE10 90 st
kolory: biały, anodowany, czarny
materiał: aluminium

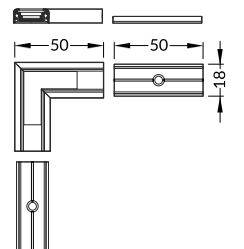
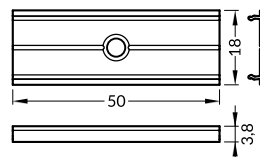

INDEX = 1 set
INDEKS = 1 komplet

X connector
łącznik X

| |
|--|
|  raw aluminium surowe aluminium 76350000 |
| L connector łącznik L |
|  white painted biały malowany 77410001 |
|  anodized anodowany 77410020 |
|  black anodized czarny anodowany 77410021 |



BEGTON12 J/S



SMALL SURFACE ALUMINIUM PROFILE

MAŁY ALUMINIOWY PROFIL NAWIERZCHNIOWY

- decorative and lighting profile
- light weight, budget profile
- Slick socket
- maximum LED strip width: 12 mm
- profil dekoracyjno-oświetleniowy
- lekki profil budżetowy
- gniazdo z funkcją Slick
- maksymalna szerokość taśmy LED: 12 mm



SIMILAR IN THE OFFER / PODOBNE W OFERCIE



SLIM8
A/Z



SMART10
A/Z



SURFACE10
BC/UX



BEGTIN12
J/S



SURFACE14
EF/TY



- J** slide cover
klosz J wsuwany
- S¹** flexible mounting plate
uchwyt S sprężysty
- S²** cone S flexible mounting plate
uchwyt S sprężysty cone

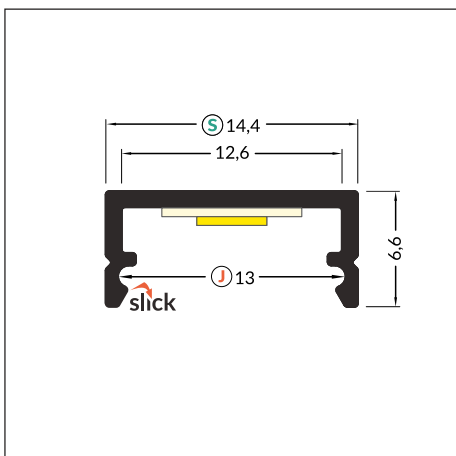
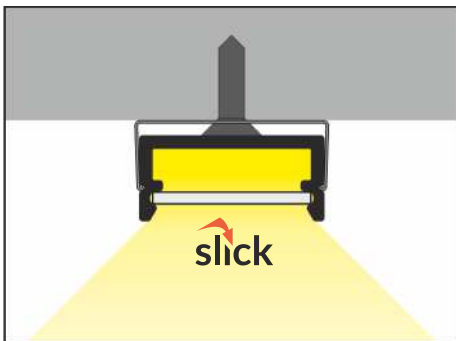
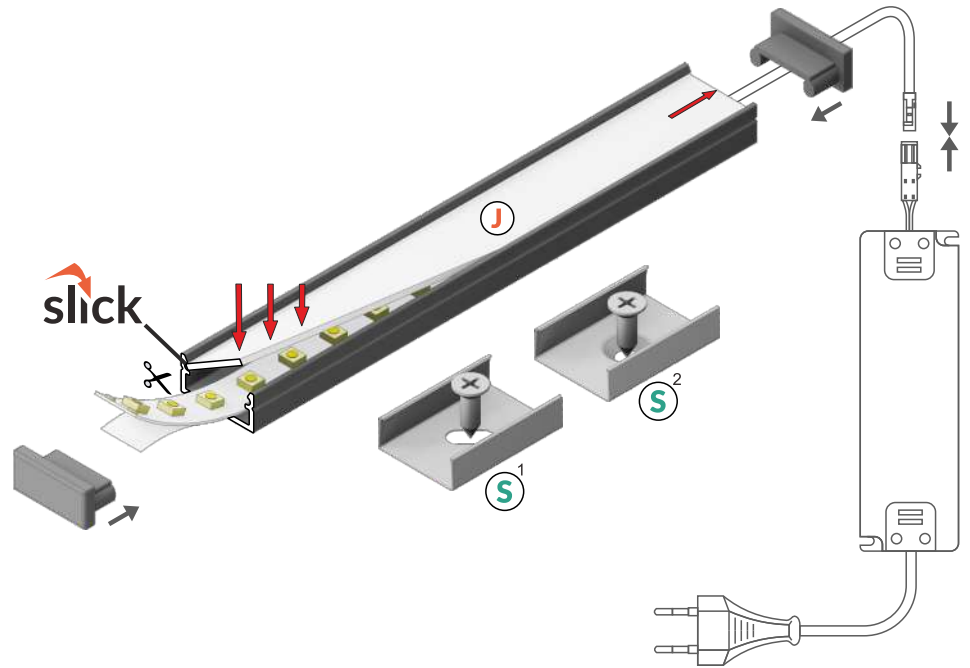

INDEX = 1 pc, length 2000 mm
 package = 10 pcs
 INDEKS = 1 szt., długość 2000 mm
 opakowanie = 10 szt.

○ white painted
biały malowany
C7020001

● anodized
anodowany
C7020020

● black anodized
czarny anodowany
C7020021

● raw aluminium
surowe aluminium
C7020000

max 12 mm

surface
nawierzchniowy

Available lengths / Dostępne długości
 1000 mm, 2000 mm, 3000 mm, 4000 mm



COVERS / KLOSZE

J slide cover

colours: transparent, frosted, white
material: PC, PP, PP

klosz J wsuwany
kolory: transparentny, szron, mleczny
materiał: PC, PP, PP



Note! Dimensions of the space to install LED source
Uwaga! Wymiary przestrzeni do zamontowania źródła LED

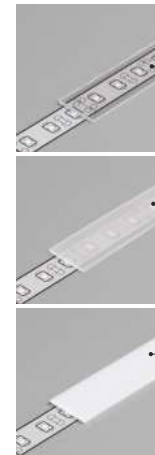
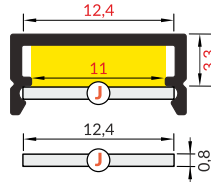

INDEX = 1 pc, length 2000 mm
package = 10 pcs
INDEKS = 1 szt., długość 2000 mm
opakowanie = 10 szt.

J transparent / J transparentny
70330016

J frosted / J szron
70330039

J white / J mleczny
70330038

ENDINGS / ZAŚLEPKI

BEGTON12 ending

colours: white, silver, black, grey
material: ABS

zaślepka BEGTON12
kolory: biały, srebrny, czarny, szary
materiał: ABS

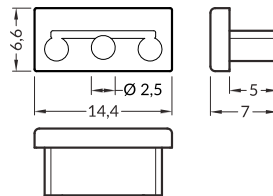

Ending with marked space to bore the holes.
Zaślepka z punktami do przewiercenia otworów.

INDEX = 1 set
package of 10 sets = 20 pcs
INDEKS = 1 komplet, opakowanie
zawiera 10 kompletów = 20 szt.

white
białe C7960001

silver
srebrne C7960040

black
czarne C7960002

grey
szare C7960022

MOUNTINGS / MOCOWANIA

S flexible mounting plate

colours: white, inox, black
material: stainless steel

uchwyt S sprężysty
kolory: biały, inox, czarny
materiał: stal nierdzewna

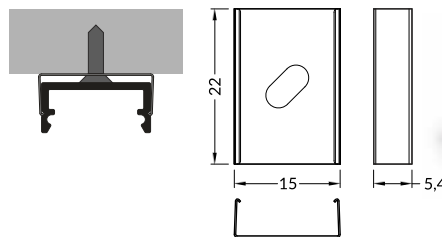

INDEX = 1 set
package of 10 sets = 20 pcs
INDEKS = 1 komplet, opakowanie
zawiera 10 kompletów = 20 szt.

white
biały C7980001

inox
inox C7980019

black
czarny C7980002

cone S flexible mounting plate

colours: white, inox, black
material: stainless steel

uchwyt S sprężysty cone
kolory: biały, inox, czarny
materiał: stal nierdzewna

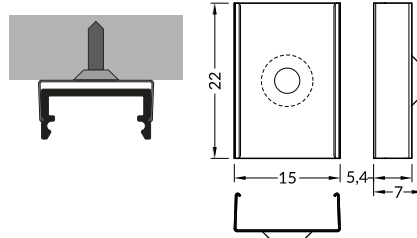

white
biały C7950001

inox
inox C7950019

black
czarny C7950002



UNI12 BCD/U

SURFACE AND RECESSED PROFILE

PROFIL WPUSTOWO-NAWIERZCHNIOWY

- decorative and lighting profile
- 7 diffusers to choose from
- increased radiation - it is possible to use a stronger LED strip
- maximum LED strip width: 12 mm
- profil oświetleniowo-dekoracyjny
- 7 kloszy do wyboru
- zwiększona radiacja - możliwość zastosowania mocniejszej taśmy LED
- maksymalna szerokość taśmy LED: 12 mm



SIMILAR IN THE OFFER / PODOBNE W OFERCIE



DEEP10
BC/UX



GROOVE10
BC/UX



SURFACE10
BC/UX



BEGTON12
J/S



FLOOR12
K/U



GROOVE14
EF/TY



SURFACE14
EF/TY



B slide cover
klosz B wsuwany

C click cover
klosz C klik

C lens cover
klosz C soczewka

D click cover
klosz D klik

U¹ flexible mounting plate
uchwyt U sprężysty

U² cone U flexible mounting plate
uchwyt U sprężysty cone

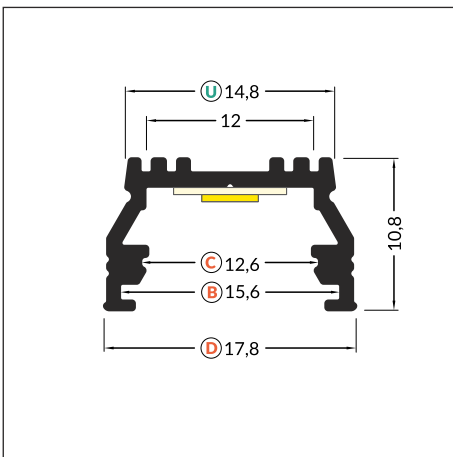
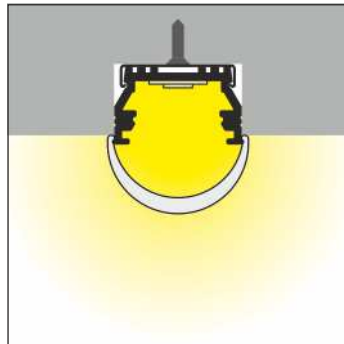
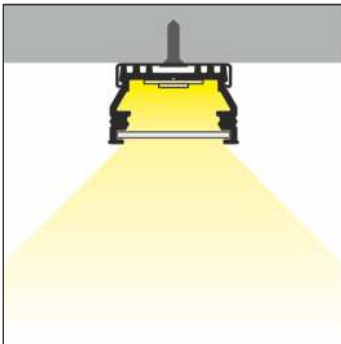
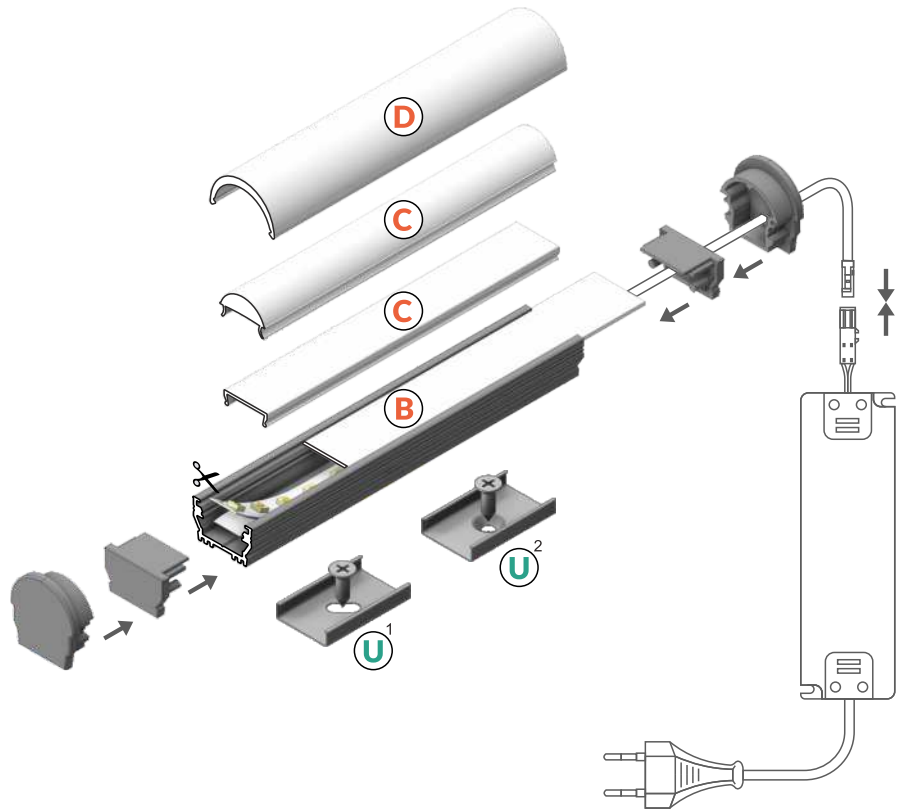

white painted
biały malowany
A1020001



anodized
anodowany
A1020020



black anodized
czarny anodowany
A1020021



raw aluminium
surowe aluminium
A1020000

INDEX = 1 pc, length 2000 mm
package = 10 pcs
INDEKS = 1 szt., długość 2000 mm
opakowanie = 10 szt.

Available lengths / Dostępne długości
1000 mm, 2000 mm, 3000 mm, 4000 mm



COVERS / KLOSZE



Note! Dimensions of the space to install LED source
Uwaga! Wymiary przestrzeni do zamontowania źródła LED

B slide cover

colours: transparent, frosted, white
material: PC, PP, PP

klosz B wsuwany
kolory: transparentny, szron, mleczny
materiał: PC, PP, PP

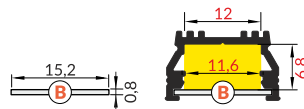

C click cover

colours: transparent, white
material: PMMA

klosz C klik
kolory: transparentny, mleczny
materiał: PMMA

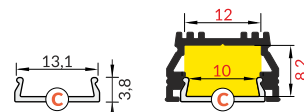

C lens click cover

colour: transparent
material: PC

klosz C klik soczewka
kolor: transparentny
materiał: PC

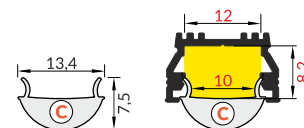

D click cover

colour: white
material: PMMA

klosz D klik
kolor: mleczny
materiał: PMMA

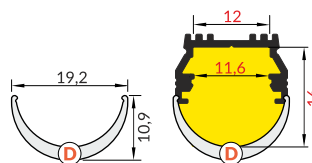

INDEX = 1 pc, length 2000 mm
package = 10 pcs
INDEKS = 1 szt., długość 2000 mm
opakowanie = 10 szt.

B transparent / B transparentny
76250016

B frosted / B szron
76250039

B white / B mleczny
76250038

C transparent / C transparentny
76330000

C white / C mleczny
76330038

C lens / C soczewka
76300000

D white / D mleczny
A1140038

MOUNTINGS / MOCOWANIA

U flexible mounting plate

colour: inox
material: stainless steel

uchwyt U sprężysty
kolor: inox
materiał: stal nierdzewna

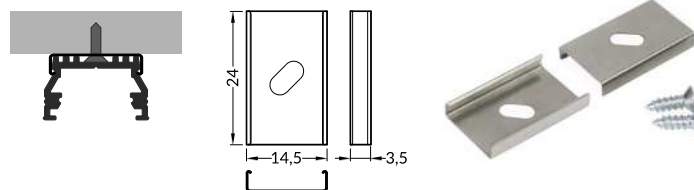

cone U flexible mounting plate

colour: inox
material: stainless steel

uchwyt U sprężysty cone
kolor: inox
materiał: stal nierdzewna

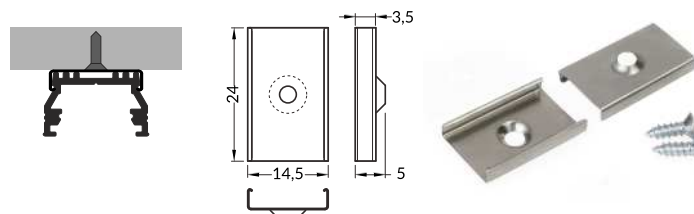

INDEX = 1 set
package of 10 sets = 20 pcs
INDEKS = 1 komplet
opakowanie zawiera 10 kpl = 20 szt

U flexible mounting plate
uchwyt U sprężysty

inox
inox 76380000

cone U flexible mounting plate
uchwyt U sprężysty cone

inox
inox 76620000

CONNECTORS / ŁĄCZNIKI

UNI12 connector 90 deg

colours: white, anodized, black
material: aluminium

łącznik UNI12 90 st
kolory: biały, anodowany, czarny
materiał: aluminium

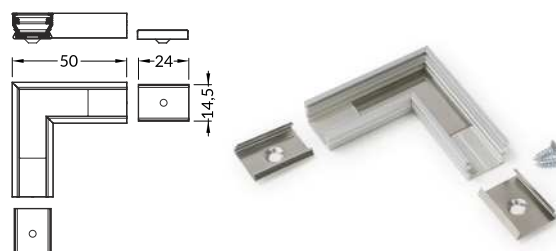

INDEX = 1 set
INDEKS = 1 komplet

white painted
biały malowany
A1910001

anodized
anodowany
A1910020

black anodized
czarny anodowany
A1910021



ENDINGS / ZAŚLEPKI

UNI12 ending

colours: white, silver, black, grey
material: ABS

zaślepka UNI12

kolory: biały, srebrny, czarny, szary
materiał: ABS

UNI12 ending with hole

colours: white, silver, black, grey
material: ABS

zaślepka UNI12 z otworem

kolory: szary, czarny, biały, srebrny
materiał: ABS

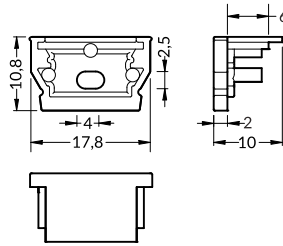

UNI12 D ending

colours: white, silver, black, grey
material: ABS

zaślepka UNI12 D

kolory: biały, srebrny, czarny, szary
materiał: ABS

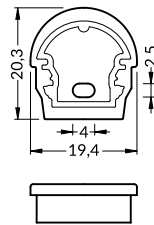

UNI12 D ending with hole

colours: white, silver, black, grey
material: ABS

zaślepka UNI12 D z otworem

kolory: szary, czarny, biały, srebrny
materiał: ABS

INDEX = 1 set
package of 10 sets = 20 pcs
INDEKS = 1 komplet, opakowanie
zawiera 10 kompletów = 20 szt.

| | | |
|--|---------------------|-------------------------|
| | white / białe | |
| | with hole z otworem | without hole bez otworu |
| | A1090001 | A1070001 |
| | silver / srebrne | |
| | with hole z otworem | without hole bez otworu |
| | A1090040 | A1070040 |
| | black / czarne | |
| | with hole z otworem | without hole bez otworu |
| | A1090002 | A1070002 |
| | grey / szare | |
| | with hole z otworem | without hole bez otworu |
| | A1090022 | A1070022 |

| | | |
|--|---------------------|-------------------------|
| | white / białe | |
| | with hole z otworem | without hole bez otworu |
| | A1960001 | A1940001 |
| | silver / srebrne | |
| | with hole z otworem | without hole bez otworu |
| | A1960040 | A1940040 |
| | black / czarne | |
| | with hole z otworem | without hole bez otworu |
| | A1960002 | A1940002 |
| | grey / szare | |
| | with hole z otworem | without hole bez otworu |
| | A1960022 | A1940022 |



SURFACE14 EF/TY

ALUMINIUM SURFACE PROFILE

ALUMINIOWY PROFIL NAWIERZCHNIOWY

- decorative and lighting profile
- hidden mounting
- maximum LED strip width: 14 mm
- profil dekoracyjno-oświetleniowy
- ukryte mocowanie
- maksymalna szerokość taśmy LED: 14 mm



SIMILAR IN THE OFFER / PODOBNE W OFERCIE

SLIM8
A/Z

SMART10
A/Z

SURFACE10
BC/UX

LINEA20
EF/TY

WIDE24
G/W



E slide cover
klosz E wsuwany

F click cover
klosz F klik

E7 click cover
klosz E7 klik

Y¹ flexible mounting plate
uchwyt Y sprężysty

Y² cone Y flexible mounting plate
uchwyt Y sprężysty cone

T mounting plate
uchwyt T

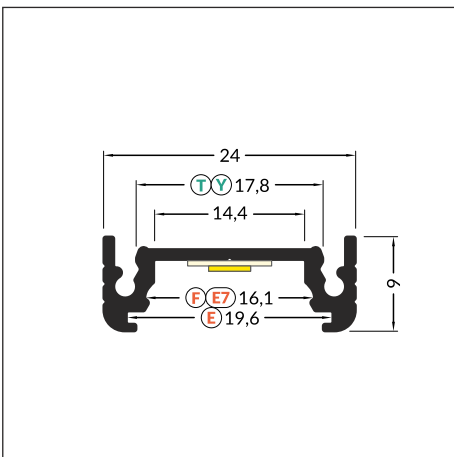
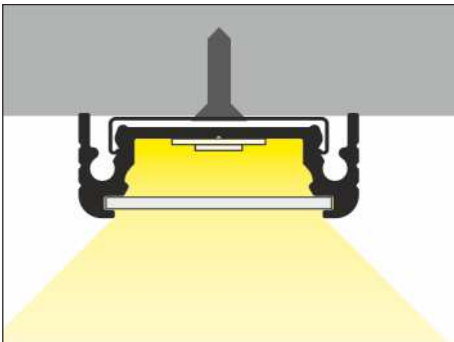
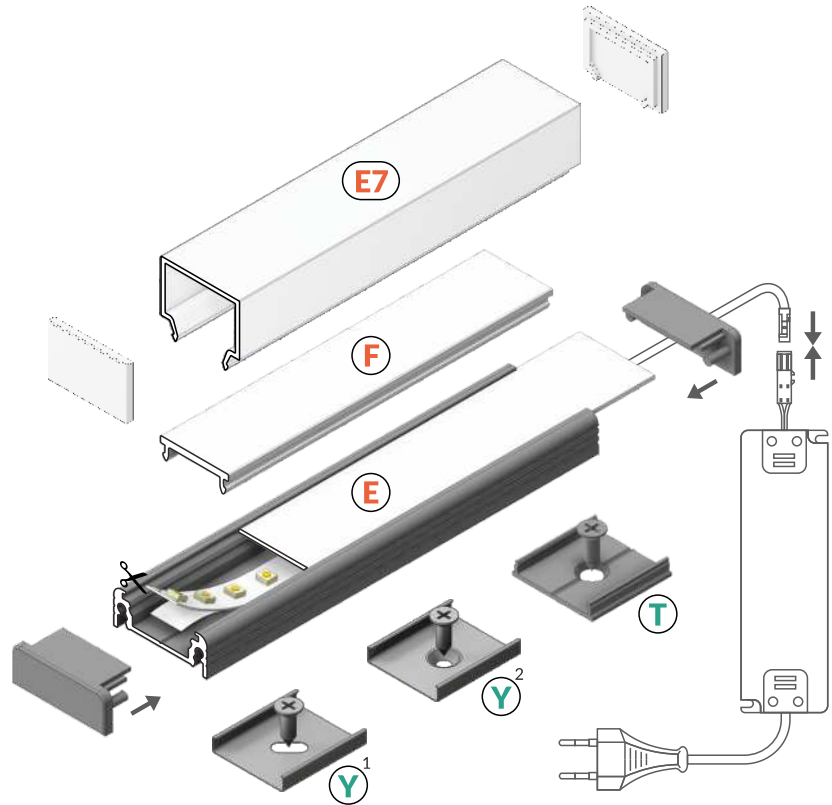

 max 14 mm

 surface
nawierzchniowy



 white painted
biały malowany
A2020001



 anodized
anodowany
A2020020



 black anodized
czarny anodowany
A2020021



 raw aluminium
surowe aluminium
A2020000

INDEX = 1 pc, length 2000 mm
package = 10 pcs
INDEKS = 1 szt., długość 2000 mm
opakowanie = 10 szt.

Available lengths / Dostępne długości
1000 mm, 2000 mm, 3000 mm, 4000 mm



COVERS / KLOSZE

E slide cover
colours: transparent, frosted, white
material: PC, PP, PP

klosz E wsuwany
kolory: przezroczysty, szron, mleczny
materiał: PC, PP, PP



Note! Dimensions of the space to install LED source
Uwaga! Wymiary przestrzeni do zamontowania źródła LED

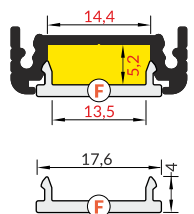
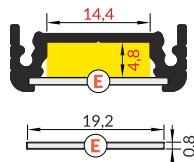

F click cover
colours: transparent, white
material: PMMA

klosz F klik
kolory: przezroczysty, mleczny
materiał: PMMA

E7 click cover
colour: white
material: PMMA

klosz E7 klik
kolor: mleczny
materiał: PMMA

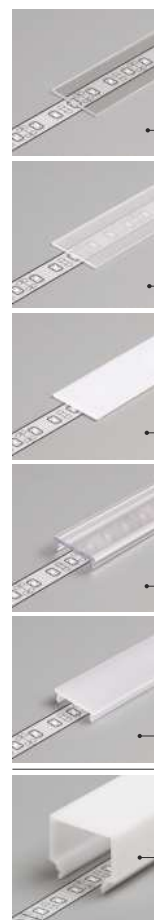
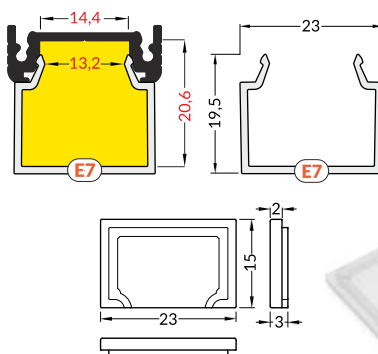

INDEX = 1 pc, length 2000 mm
package = 10 pcs
INDEKS = 1 szt., długość 2000 mm
opakowanie = 10 szt.

E transparent / E transparentny
A2040016

E frosted / E szron
A2040039

E white / E mleczny
A2040038

F transparent / F transparentny
A2060016

F white / F mleczny
A2060038

E7 white / E7 mleczny
C1080038

INDEX = 1 set
package of 10 sets = 20 pcs
INDEKS = 1 komplet, opakowanie
zawiera 10 kompletów = 20 szt.

E7 white ending
zaślepka E7 mleczny
C1840038

MOUNTINGS / MOCOWANIA

Y flexible mounting plate
colour: inox
material: stainless steel

uchwyt Y sprężysty
kolor: inox
materiał: stal nierdzewna

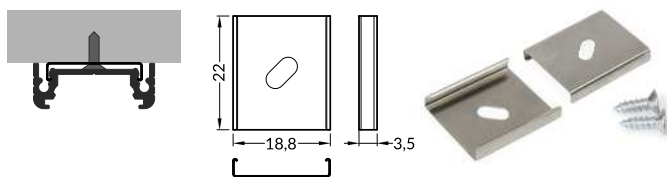

INDEX = 1 set
package of 10 sets = 20 pcs
INDEKS = 1 komplet, opakowanie
zawiera 10 kompletów = 20 szt.

Y flexible mounting plate
uchwyt Y sprężysty

inox
inox A2090019

cone Y flexible mounting plate
colour: inox
material: stainless steel

uchwyt Y sprężysty cone
kolor: inox
materiał: stal nierdzewna

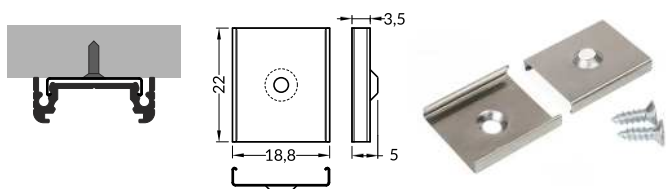

cone Y flexible mounting plate
uchwyt Y sprężysty cone

inox
inox A2130019

T mounting plate
colour: raw aluminium
material: aluminium

uchwyt T
kolor: surowe aluminium
materiał: aluminium

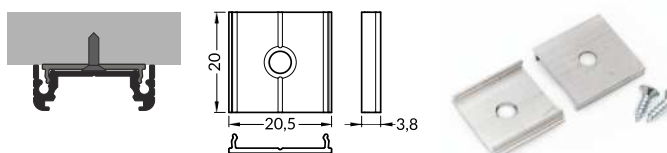

T mounting plate
uchwyt T

raw aluminium
surowe aluminium
C6960000



ENDINGS / ZAŚLEPKI

SURFACE14 ending

colours: white, silver, black, grey
material: ABS

zaślepka SURFACE14

kolory: biały, srebrny, czarny, szary
materiał: ABS

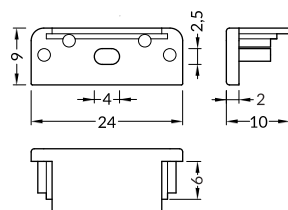

SURFACE14 ending with hole

colours: white, silver, black, grey
material: ABS

zaślepka SURFACE14 z otworem

kolory: biały, srebrny, czarny, szary
materiał: ABS

INDEX = 1 set
package of 10 sets = 20 pcs
INDEKS = 1 komplet, opakowanie
zawiera 10 kompletów = 20 szt.

white
białe

with hole z otworem | without hole bez otworu
A2100001 | A2070001

silver
srebrne

with hole z otworem | without hole bez otworu
A2100040 | A2070040

black
czarne

with hole z otworem | without hole bez otworu
A2100002 | A2070002

grey
szare

with hole z otworem | without hole bez otworu
A2100022 | A2070022

CONNECTORS / ŁĄCZNIKI

T connector 180 deg

colour: raw aluminium
material: aluminium

łącznik T 180 st

kolor: surowe aluminium
materiał: aluminium

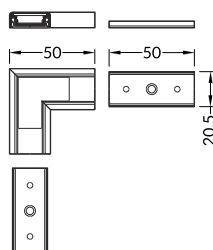
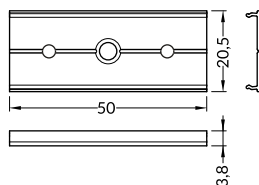

SURFACE14 connector 90 deg

colours: white, anodized, black
material: aluminium

łącznik SURFACE14 90 st

kolory: biały, anodowany, czarny
materiał: aluminium

INDEX = 1 set
INDEKS = 1 komplet

T connector / łącznik T

raw aluminium
surowe aluminium
C6990000

connector 90 deg / łącznik 90 st

white painted
biały malowany
A2990001

anodized
anodowany
A2990020

black anodized
czarny anodowany
A2990021



SMART16 B/U4



ECONOMICAL PROFILE FOR 16 mm LED STRIP

EKONOMICZNY PROFIL DO TAŚM 16 mm

- SLICK socket - easy assembly technology
- 2 channels for mounting bracket (with or without mounting surface distance)
- continuous line of light (when using LED strip 120 P/m and white cover)
- maximum width of LED strip: 16 mm
- gniazdo SLICK - prosty montaż klosza
- 2 rowki - 2 poziomy przymocowania uchwyty (z dystansem od płaszczyzny montażowej lub bez)
- ciągła linia światła (przy zastosowaniu taśmy 120 P/m i klosza mlecznego)
- maksymalna szerokość taśmy LED: 16 mm



SIMILAR IN THE OFFER / PODOBNE W OFERCIE





B slide cover
klosz B wsuwany

U4¹ U4 mounting plate
uchwyt U4

U4² cone U4 mounting plate
uchwyt U4 cone

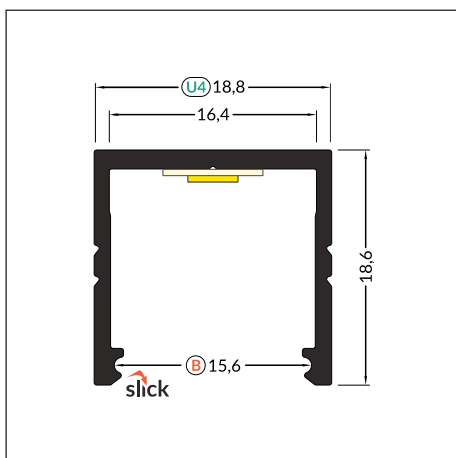
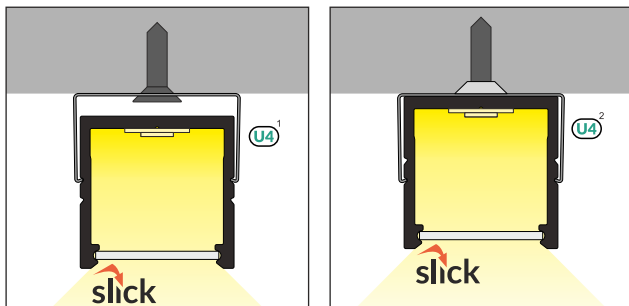
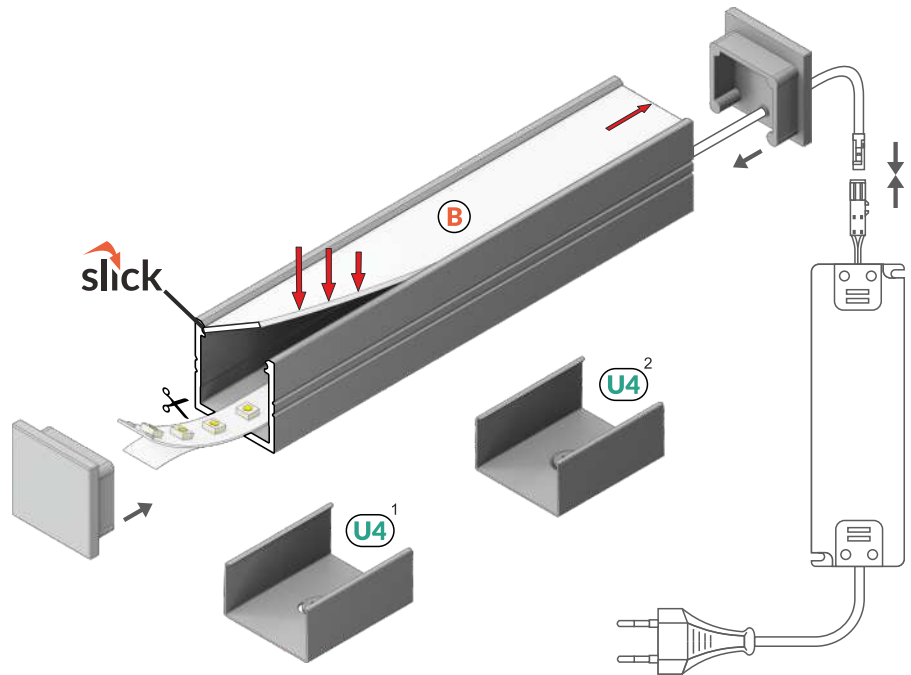

white painted
biały malowany
F1020001



anodized
anodowany
F1020020



black anodized
czarny anodowany
F1020021



raw aluminium
surowe aluminium
F1020000

INDEX = 1 pc, length 2000 mm
package = 10 pcs
INDEKS = 1 szt., długość 2000 mm
opakowanie = 10 szt.

Available lengths / Dostępne długości
1000 mm, 2000 mm, 3000 mm, 4000 mm



COVERS / KLOSZE

B slide cover

colours: transparent, frosted, white
material: PC, PP, PP

klosz B wsuwany
kolory: transparentny, szron, mleczny
materiał: PC, PP, PP



Note! Dimensions of the space to install LED source
Uwaga! Wymiary przestrzeni do zamontowania źródła LED

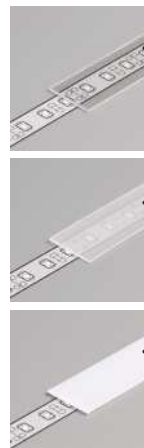
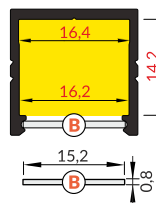

INDEX = 1 pc, length 2000 mm
package = 10 pcs
INDEKS = 1 szt., długość 2000 mm
opakowanie = 10 szt.

B transparent / B transparentny
76250016

B frosted / B szron
76250039

B white / B mleczny
76250038

ENDINGS / ZAŚLEPKI

SMART16 ending

colours: white, silver, black, grey
material: ABS

zaślepka SMART16
kolory: biały, srebrny, czarny, szary
materiał: ABS

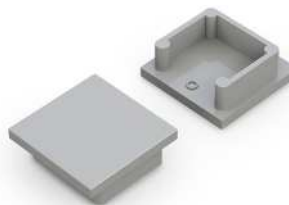
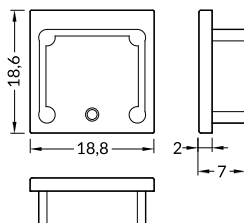

Ending with marked space to bore the holes.
Zaślepka z punktami do przewiercenia otworów.

INDEX = 1 set
package of 10 sets = 20 pcs
INDEKS = 1 komplet, opakowanie
zawiera 10 kompletów = 20 szt.

white / biały
F1990001

silver / srebrny
F1990040

black / czarny
F1990002

grey / szary
F1990022

MOUNTINGS / MOCOWANIA

U4 mounting plate
colours: white, inox, black
material: stainless steel

uchwyt U4
kolory: biały, inox, czarny
materiał: stal nierdzewna

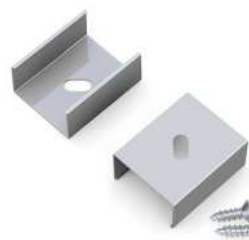
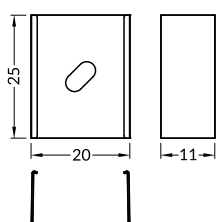
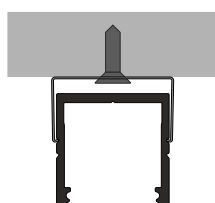

INDEX = 1 set
package of 10 sets = 20 pcs
INDEKS = 1 komplet, opakowanie
opakowanie zawiera 10 kpl = 20 szt

U4 mounting plate
uchwyt U4

white biały F1970001

inox inox F1970019

black czarny F1970002

cone U4 mounting plate
colours: white, inox, black
material: stainless steel

uchwyt U4 cone
kolory: biały, inox, czarny
materiał: stal nierdzewna

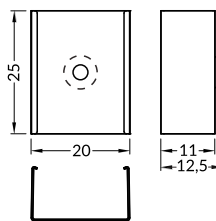
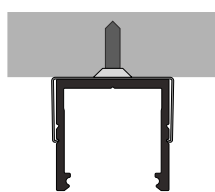

cone U4 mounting plate
uchwyt U4 cone

white biały F1980001

inox inox F1980019

black czarny F1980002



LINEA20 EF/TY

EFFICIENT LUMINAIRE CUT TO SIZE

WYDAJNA OPRAWA Z METRA

- lighting profile
 - over 20 accessories available
 - possibility of suspension along with the power supply
 - LED modules are assembled with extra clamps
 - angled connections illuminated
 - continuous light line (with 120 P/m LED strip and white cover applied)
 - maximum LED source width: 20 mm
- profil oświetleniowy
 - ponad 20 akcesoriów
 - możliwość zawieszenia na zasilaniu
 - montaż modułów LED dociskiem
 - świecące połączenia kątowe
 - ciągła linia światła (przy użyciu taśm 120 P/m oraz klosza mlecznego)
 - maksymalna szerokość źródła LED: 20 mm

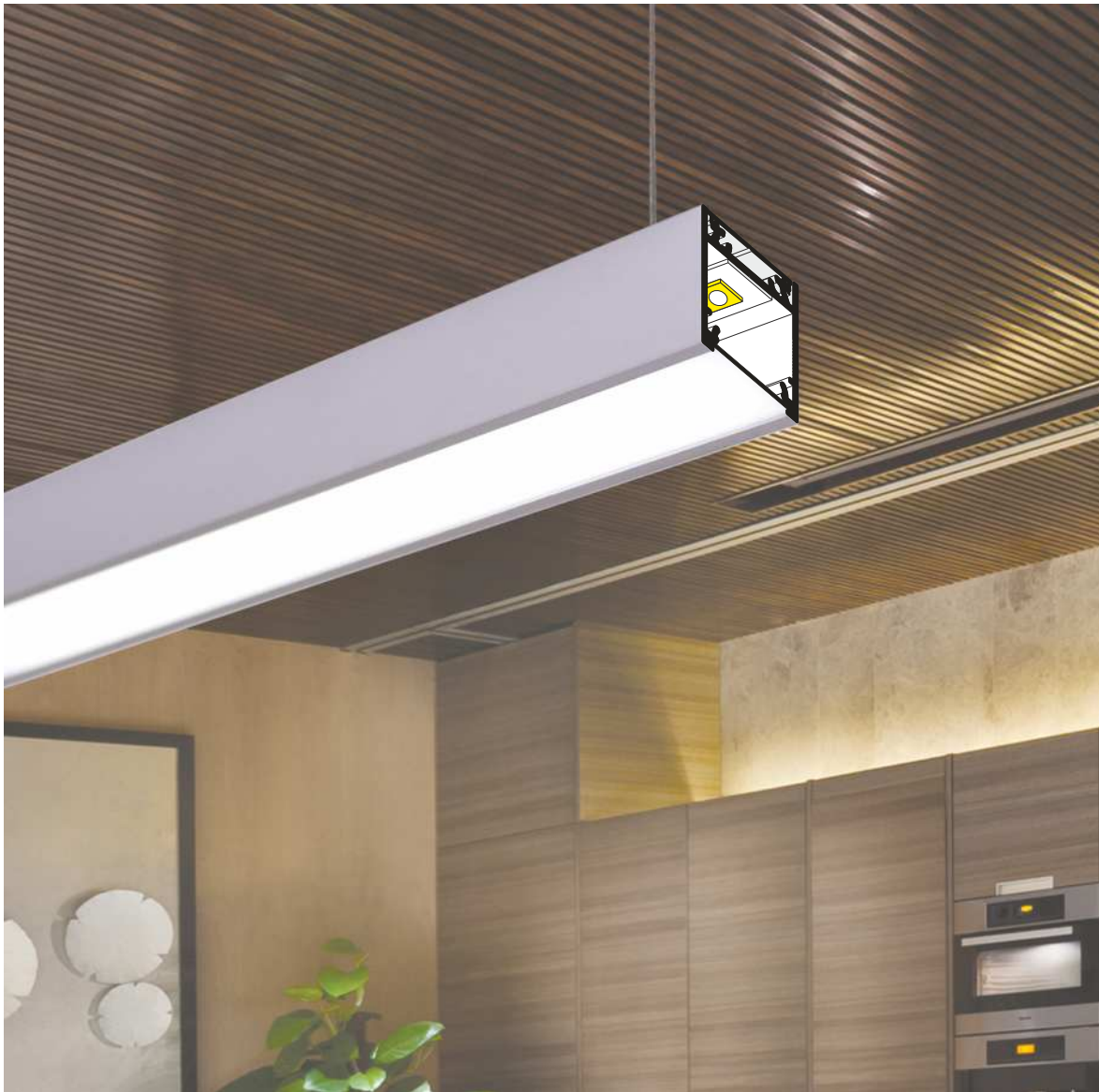

SIMILAR IN THE OFFER / PODOBNE W OFERCIE





E **E** slide cover
klosz **E** wsuwany

F **F** click cover
klosz **F** klik

E7 **E7** click cover
klosz **E7** klik

Y¹ **Y** flexible mounting plate
uchwyt **Y** sprężysty

Y² **cone Y** flexible mounting plate
uchwyt **Y** sprężysty cone

T **T** mounting plate
uchwyt **T**

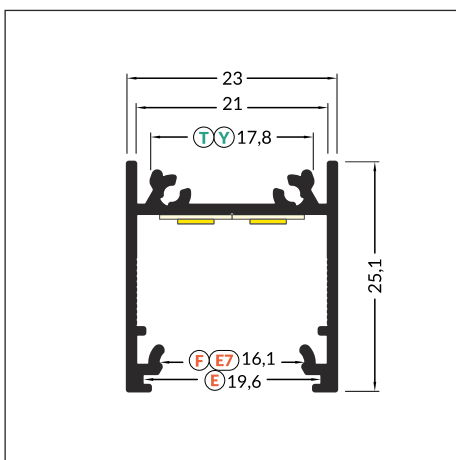
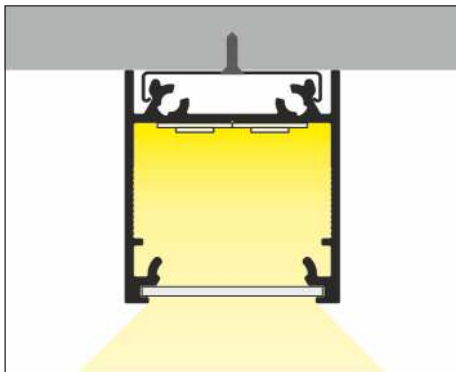
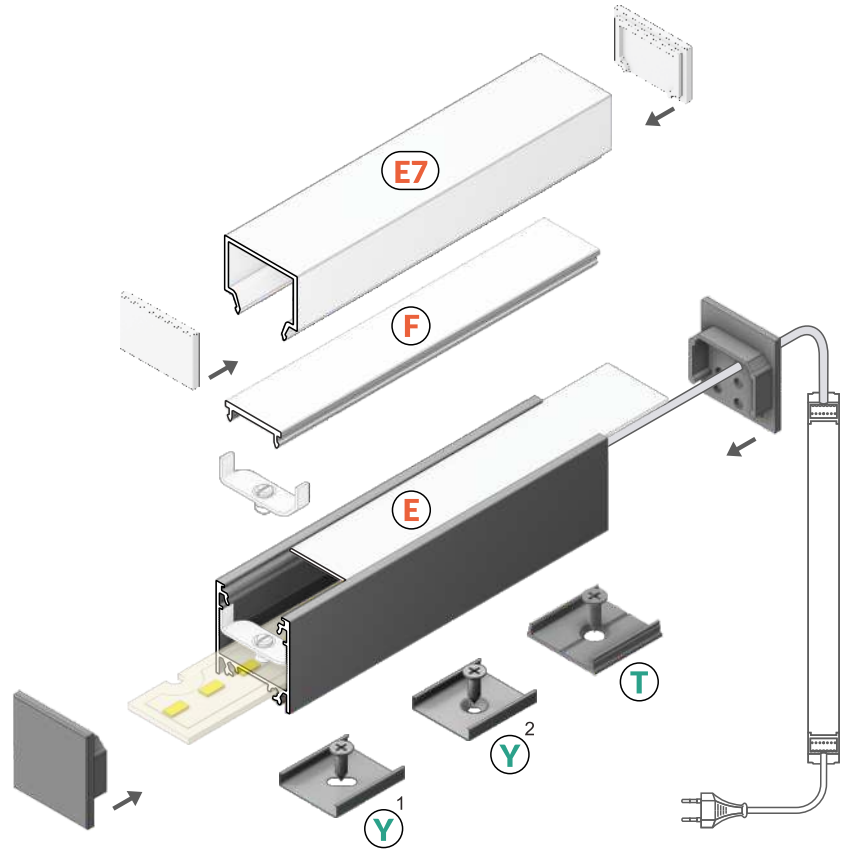

max 20 mm

surface
nawierzchniowy

INDEX = 1 pc, length 2000 mm
package = 10 pcs
INDEKS = 1 szt., długość 2000 mm
opakowanie = 10 szt.

white painted
biały malowany
C1020001

anodized
anodowany
C1020020

black anodized
czarny anodowany
C1020021

raw aluminium
surowe aluminium
C1020000

Available lengths / Dostępne długości
1000 mm, 2000 mm, 3000 mm, 4000 mm

LINEA20 EF/TY



CONTINUOUS LIGHT LINE
The LINEA20 180° connector provides an aesthetic, continuous light line of any length.

CIĄGŁA LINIA ŚWIATŁA
Dzięki wykorzystaniu łącznika LINEA20 180° możliwe jest uzyskanie estetycznej, nieprzerwanej linii światła o dowolnej długości.



COVERS / KLOSZE

E slide cover
colours: transparent, frosted, white
material: PC, PP, PP

klosz **E** wsuwany
kolory: transparentny, szron, mleczny
materiał: PC, PP, PP



Note! Dimensions of the space to install LED source
Uwaga! Wymiary przestrzeni do zamontowania źródła LED

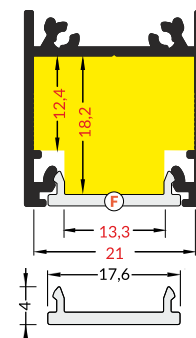
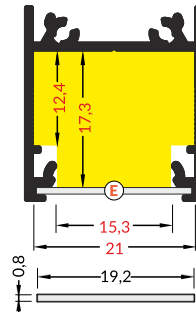

F click cover
colours: transparent, white
material: PMMA

klosz **F** klik
kolory: transparentny, mleczny
materiał: PMMA

E7 click cover
colour: white
material: PMMA

klosz **E7** klik
kolor: mleczny
materiał: PMMA

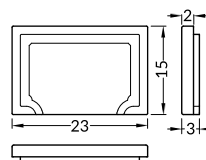
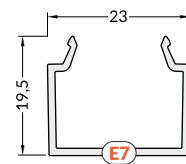
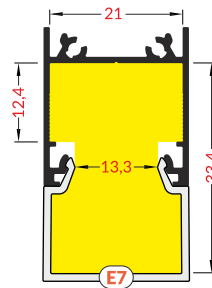

INDEX = 1 pc, length 2000 mm
package = 10 pcs
INDEKS = 1 szt., długość 2000 mm
opakowanie = 10 szt.

E transparent / E transparentny
A2040016

E frosted / E szron
A2040039

E white / E mleczny
A2040038

F transparent / F transparentny
A2060016

F white / F mleczny
A2060038

E7 white / E7 mleczny
C1080038

INDEX = 1 set
package of 10 sets = 20 pcs
INDEKS = 1 komplet, opakowanie
zawiera 10 kompletów = 20 szt.

E7 white ending
zaślepka **E7** mleczny
C1840038



LED MOUNTING / MOCOWANIE LED

LINEA20 LED mounting
material: aluminium

mocowanie LED LINEA20
materiał: aluminium

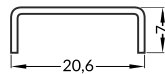

INDEX = 1 pc, length 2000 mm
package = 10 pcs
INDEKS = 1 szt., długość 2000 mm
opakowanie = 10 szt.

 raw aluminium,
surowe aluminium
C6060000

LIGHTING EFFECT / EFEKT ŚWIECENIA

LINEA20 LED mounting + LINEA20-1 LED clamp / Mocowanie LED LINEA20 + docisk LED LINEA20-1



Lighting effect without LINEA20 LED mounting / Efekt świecenia bez użycia mocowania LED LINEA20





CLAMP / DOCISK

LINEA20 LED clamp
colour: white
material: painted steel, plastic

docisk LED LINEA20
kolor: biały
materiał: stal malowana,
tworzywo

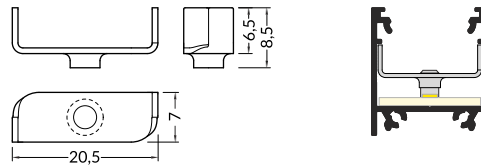

LINEA20-1 LED clamp
colour: white
material: painted steel, plastic

docisk LED LINEA20-1
kolor: biały
materiał: stal malowana,
tworzywo

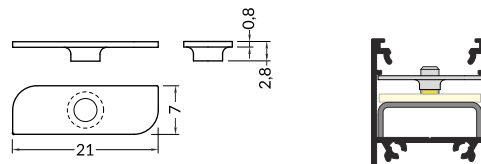

INDEX = 1 set
package of 10 sets = 20 pcs
INDEKS = 1 komplet, opakowanie
zawiera 10 kompletów = 20 szt.

white
biały C6940001

white
biały C6930001

ENDINGS / ZAŚLEPKI

LINEA20 ending
colours: white, silver, black, grey
material: ABS

zaślepka LINEA20
kolory: biały, srebrny, czarny, szary
materiał: ABS

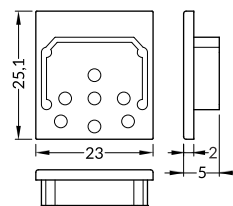

Ending with marked space to bore the holes.
Possibility of buying dedicated screws.
Zaślepka z punktami do przewiercenia otworów.
Istnieje możliwość zakupu dedykowanych wkrętów.

INDEX = 1 set
package of 10 sets = 20 pcs
INDEKS = 1 komplet, opakowanie
zawiera 10 kompletów = 20 szt.

white
biały C1940001

silver
srebrne C1940040

black
czarny C1940002

grey
szare C1940022

screws for LED endings
colours: white, silver, black, inox

wkręty do zaślepek LED
kolory: biały, srebrny, czarny, inox

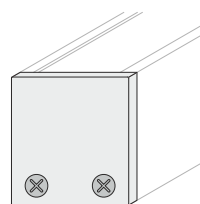

INDEX = 1 set
package of 10 sets = 40 pcs
INDEKS = 1 komplet, opakowanie
zawiera 10 kompletów = 40 szt.

white
biały B1900001

silver
srebrne B1900040

black
czarny B1900002

inox
inox B1900019

LINEA20 EF/TY

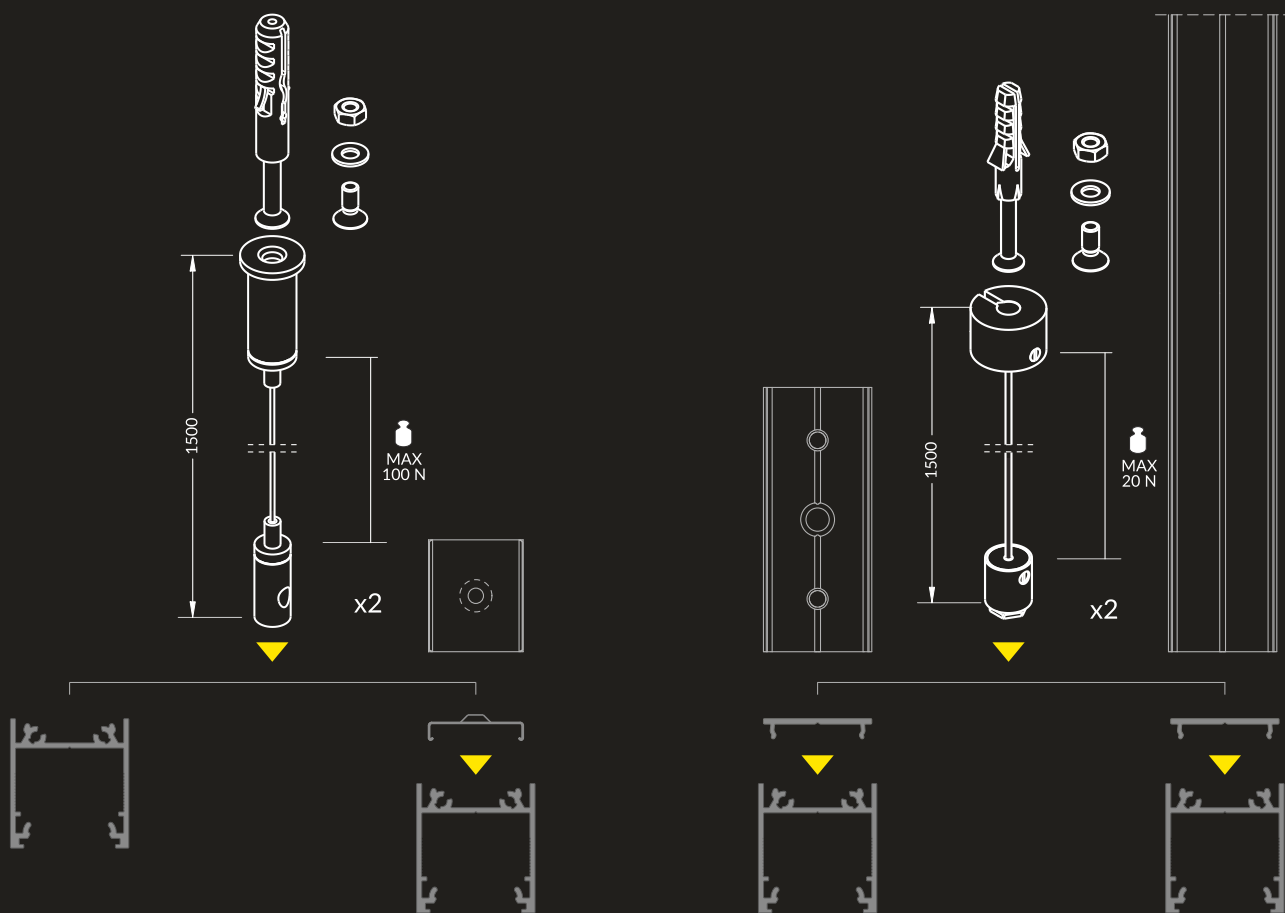

SLING FOR LED MOUNTING 1500

Compatible with flexible mounting plates, allows fast and easy assembly of the luminaire. Possibility of direct mounting to the profile.

ZAWIESIE DO UCHWYTU LED 1500

Kompatybilność z uchwytami sprężystymi, pozwala na szybki i łatwy montaż oprawy. Możliwy jest również montaż bezpośrednio do profilu.



SELV SLING 50 V 1500

It provides a minimalistic look – no additional wires required.

ZAWIESIE ZASILAJĄCE SELV 50 V 1500

Zapewnia minimalistyczny wygląd - bez konieczności doprowadzania dodatkowych przewodów.

Using FIX16 profile creates an aesthetic, closed from the top, luminaire.

Przy zastosowaniu profilu FIX16 tworzymy estetyczną, domkniętą od góry oprawę.

Drill Ø 5 mm mounting holes in FIX16

W profilu FIX16 należy wykonać otwory montażowe Ø 5 mm



MOUNTINGS / MOCOWANIA

Y flexible mounting plate

colour: inox
material: stainless steel

uchwyt Y sprężysty
kolor: inox
materiał: stal nierdzewna

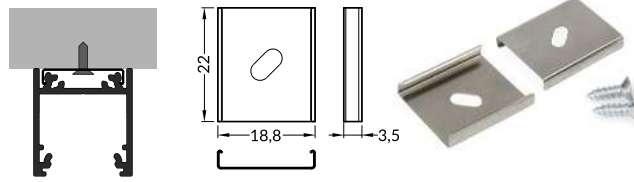

INDEX = 1 set
package of 10 sets = 20 pcs
INDEKS = 1 komplet, opakowanie
zawiera 10 kompletów = 20 szt.

Y flexible mounting uchwyt Y sprężysty

inox **A2090019**

cone Y flexible mounting plate

colour: inox
material: stainless steel

uchwyt Y sprężysty cone
kolor: inox
materiał: stal nierdzewna

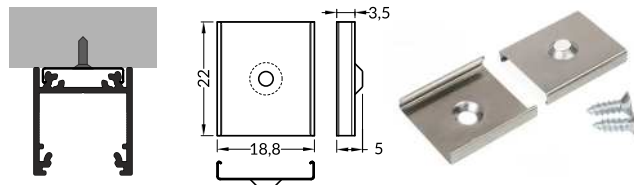

cone Y flexible mounting plate uchwyt Y sprężysty cone

inox **A2130019**

T mounting plate

colour: raw aluminium
material: aluminium

uchwyt T
kolor: surowe aluminium
materiał: aluminium

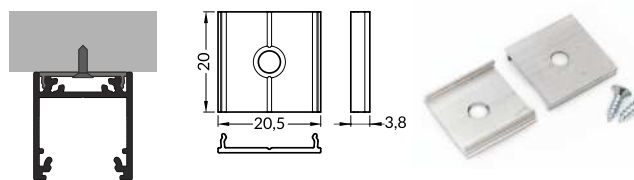

T mounting plate uchwyt T

raw aluminium
surowe aluminium
C6960000

ALUMINIUM COVER / OSŁONA ALUMINIOWA

LED profile FIX16

colours: white, anodized, black, raw aluminium
material: aluminium

profil LED FIX16
kolory: biały, anodowany, czarny, surowe aluminium
materiał: aluminium

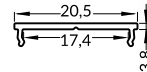

INDEX = 1 pc, length 2000 mm
package = 10 pcs
INDEKS = 1 szt., długość 2000 mm
opakowanie = 10 szt.

white painted
biały malowany
C6020001

anodized
anodowany
C6020020

black anodized
czarny anodowany
C6020021

raw aluminium
surowe aluminium
C6020000

Available lengths / Dostępne długości
1000 mm, 2000 mm, 3000 mm, 4000 mm

SLING / ZAWIESIE

SELV sling 50 V 1500

colours: white, silver, black

zawiesie SELV 50 V 1500
kolory: biały, srebro, czarny



INDEX = 1 set
INDEKS = 1 zestaw

SELV sling 50 V 1500
zawiesie SELV 50 V 1500

white
biały **67120001**

silver
srebrne **67120022**

black
czarny **67120002**

sling for LED mounting 1500

colour: chrome

zawiesie do uchwyту LED 1500
kolor: chrom



sling for LED mounting 1500
zawiesie do uchwyту LED 1500

chrome
chrom **67140003**

LINEA20 EF/TY

CONNECTION POSSIBILITY MOŻLIWOŚCI ŁĄCZENIA



60°



90°



120°



135°



180°

ANGULAR CONNECTORS

Thanks to five different angle connectors (60° / 90° / 120° / 135° / 180°) it is possible to create many various lighting systems - with no need to cut the profile at an angle.

Bent connectors allows to connect profiles in two planes, at two angles: 90° on the inside and 270° on the outside.

ŁĄCZNIKI KĄTOWE

Dzięki łącznikom o pięciu różnych kątach (60° / 90° / 120° / 135° / 180°) możliwe jest tworzenie wielu różnych układów oświetlenia bez konieczności cięcia profilu pod skosem.

Łączniki gięte umożliwiają łączenie profili w dwóch płaszczyznach, pod dwoma kątami: wewnętrznym 90° i zewnętrznym 270°.



The component made of clear fabric provides secure connection, letting light through at the same time. Thanks to that, the luminaire can illuminate on the entire surface of the cover - even in the corners.

Element z przejrzystego tworzywa zapewnia stabilizację łączenia, jednocześnie przepuszczając światło. Dzięki temu oprawa może świecić na całej powierzchni klosza - również w rogach.



CONNECTORS / ŁĄCZNIKI

LINEA20 connector 60 deg
colours: white, anodized, black
material: aluminium, polycarbonate

łącznik LINEA20 60 st
kolory: biały, anodowany, czarny
materiał: aluminium, poliwęglan

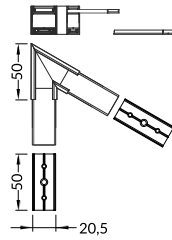

LINEA20 connector 90 deg
colours: white, anodized, black
material: aluminium, polycarbonate

łącznik LINEA20 90 st
kolory: biały, anodowany, czarny
materiał: aluminium, poliwęglan

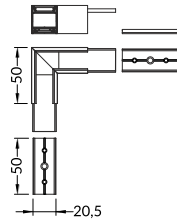

LINEA20 connector 90 deg bent
colours: white, anodized, black
material: aluminium, polycarbonate

łącznik LINEA20 90 st gięty
kolory: biały, anodowany, czarny
materiał: aluminium, poliwęglan

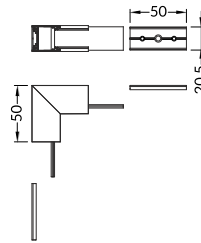

LINEA20 connector 120 deg
colours: white, anodized, black
material: aluminium, polycarbonate

łącznik LINEA20 120 st
kolory: biały, anodowany, czarny
materiał: aluminium, poliwęglan

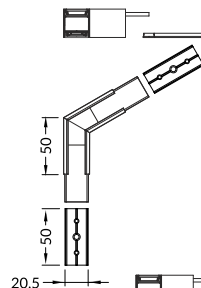

LINEA20 connector 135 deg
colours: white, anodized, black
material: aluminium, polycarbonate

łącznik LINEA20 135 st
kolory: biały, anodowany, czarny
materiał: aluminium, poliwęglan

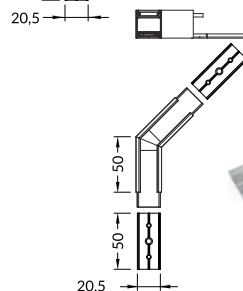

LINEA20 connector 180 deg
material: aluminium, polycarbonate

łącznik LINEA20 180 st
materiał: aluminium, poliwęglan

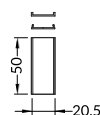

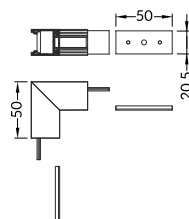

LINEA20 connector 270 deg bent
colours: white, anodized, black
material: aluminium, polycarbonate

łącznik LINEA20 270 st gięty
kolory: biały, anodowany, czarny
materiał: aluminium, poliwęglan





INDEX = 1 set
INDEKS = 1 zestaw



connector 60 deg
łącznik 60 st

-  white biały **C1850001**
-  anodized anodowany **C1850020**
-  black czarny **C1850002**



connector 90 deg
łącznik 90 st

-  white biały **C1860001**
-  anodized anodowany **C1860020**
-  black czarny **C1860002**



connector 90 deg bent
łącznik 90 st gięty

-  white biały **C1870001**
-  anodized anodowany **C1870020**
-  black czarny **C1870002**

connector 120 deg
łącznik 120 st

-  white biały **C1880001**
-  anodized anodowany **C1880020**
-  black czarny **C1880002**



connector 135 deg
łącznik 135 st

-  white biały **C1890001**
-  anodized anodowany **C1890020**
-  black czarny **C1890002**

connector 180 deg
łącznik 180 st

C1900000

connector 270 deg bent
łącznik 270 st gięty

-  white biały **C1910001**
-  anodized anodowany **C1910020**
-  black czarny **C1910002**

LINEA20 EF/TY





PENDANT LUMINAIRE

Thanks to wide range of profile accessories it could be applied in many arrangements. SELV sling 50 V 1500 and FIX16 closing profile allows to create pendant luminaire with a small intersection, but strong light.

OPRAWA WISZĄCA

Dzięki licznym akcesoriom profil można zastosować w wielu aranżacjach. Zawiesie SELV 50 V 1500 oraz domykający profil FIX16 pozwalają stworzyć wiszącą oprawę o niewielkim przekroju, ale dającą silne światło.

WIDE, ALUMINIUM, SURFACE PROFILE

SZEROKI, ALUMINIOWY PROFIL NAWIERZCHNIOWY

- lighting and decorative profile
- possibility of installing 3 8 mm LED strips
- Slick socket
- maximum LED strip width: 24 mm
- profil oświetleniowo-dekoracyjny
- możliwość zastosowania równoległe 3 taśm 8 mm
- gniazdo z funkcją Slick
- maksymalna szerokość taśmy LED: 24 mm



SIMILAR IN THE OFFER / PODOBNE W OFERCIE

SURFACE10
BC/UX

UNI12
BCD/U

BEGTON12
J/S

SURFACE14
EF/TY

LINEA20
EF/TY



VARIO30-02

VARIO30-01

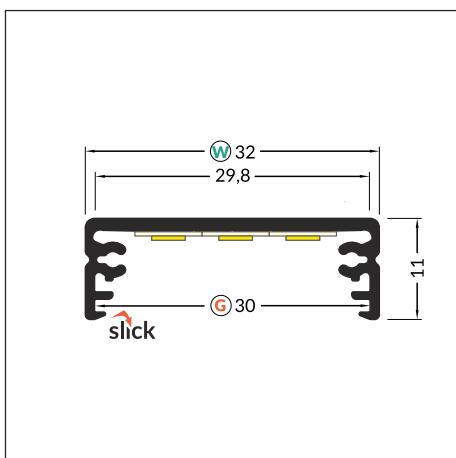
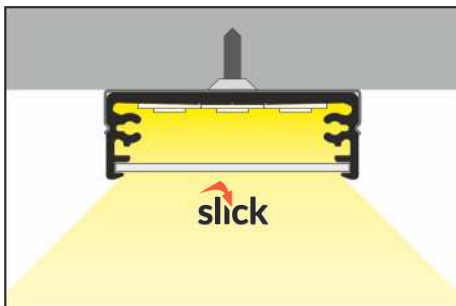
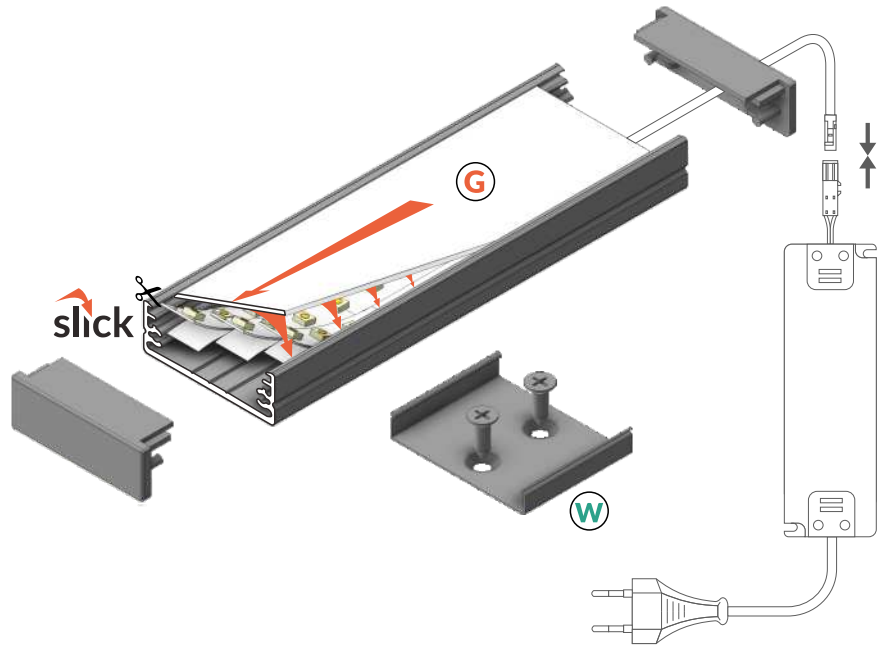

G slide cover
klosz G wsuwany

W cone W flexible mounting plate
uchwyt W sprężysty cone



white painted
biały malowany
84030001



anodized
anodowany
84030020



black anodized
czarny anodowany
84030021



raw aluminium
surowe aluminium
84030000

 max 24 mm

 surface
nawierzchniowy

Available lengths / Dostępne długości
1000 mm, 2000 mm, 3000 mm, 4000 mm



COVERS / KLOSZE

G slide cover
colours: transparent, frosted, white
material: PC, PP, PP

klosz G wsuwany
kolory: transparentny, szron, mleczny
materiał: PC, PP, PP



Note! Dimensions of the space to install LED source
Uwaga! Wymiary przestrzeni do zamontowania źródła LED

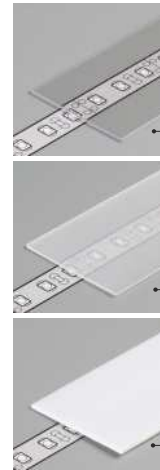
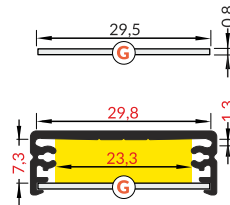

INDEX = 1 pc, length 2000 mm
package = 10 pcs
INDEKS = 1 szt., długość 2000 mm
opakowanie = 10 szt.

G transparent / G transparentny
84070016

G frosted / G szron
84070039

G white / G mleczny
84070038

ENDINGS / ZAŚLEPKI

WIDE24 ending
colours: white, silver, black, grey
material: ABS

zaślepka WIDE24
kolory: biały, srebrny, czarny, szary
materiał: ABS

WIDE24 ending with hole
colours: white, silver, black, grey
material: ABS

zaślepka WIDE24 z otworem
kolory: szary, czarny, biały, srebrny
materiał: ABS

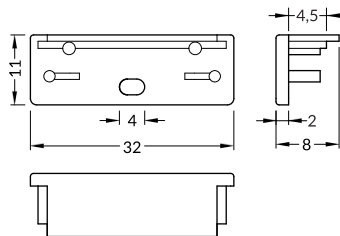

INDEX = 1 set
package of 10 sets = 20 pcs
INDEKS = 1 komplet, opakowanie
zawiera 10 kompletów = 20 szt.

white
białe

with hole z otworem
84300001

without hole bez otworu
84040001

silver
srebrne

with hole z otworem
84300040

without hole bez otworu
84040040

black
czarne

with hole z otworem
84300002

without hole bez otworu
84040002

grey
szare

with hole z otworem
84300022

without hole bez otworu
84040022

MOUNTINGS / MOCOWANIA

cone W flexible mounting plate
colour: inox
material: stainless steel

uchwyt W sprężysty cone
kolor: inox
materiał: stal nierdzewna

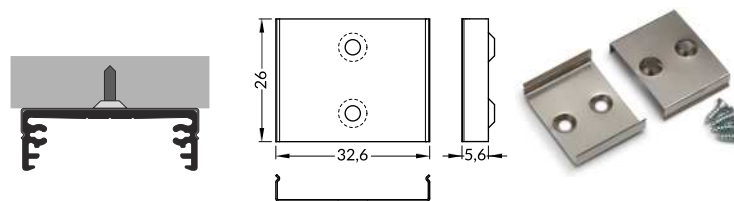

INDEX = 1 set
package of 10 sets = 20 pcs
INDEKS = 1 komplet
opakowanie zawiera 10 kpl = 20 szt.

cone W flexible mounting plate
uchwyt W sprężysty cone

white painted
biały malowany 84510001

inox
inox 84510019

black painted
czarny malowany 84510002

WIDE24 simple holder
material: zinc coated steel

uchwyt WIDE24 prosty
materiał: stal ocynkowana

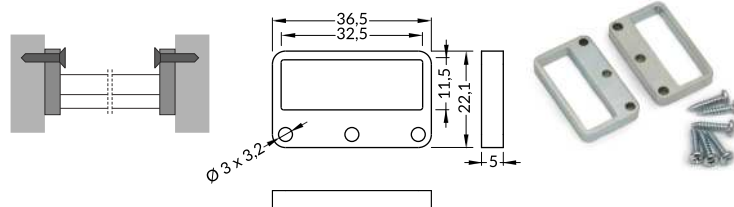

INDEX = 1 set = 2 pcs
INDEKS = 1 komplet = 2 szt.

simple holder
uchwyt prosty

zinc coated
stal ocynkowana
84220030



SLING / ZAWIESIE

SELV sling 50 V 1500
colours: white, silver, black

zawiesie SELV 50 V 1500
kolory: biały, srebrny, czarny

sling for LED mounting 1500
colour: chrome

zawiesie do uchwytu LED 1500
kolor: chrom



INDEX = 1 set
INDEKS = 1 zestaw

SELV sling 50 V 1500
zawiesie SELV 50 V 1500

 white
biały **67120001**

 silver
srebrny **67120022**

 black
czarny **67120002**

sling for LED mounting 1500
zawiesie do uchwytu LED 1500

 chrome
chrom **67140003**





**RECESSED
WPUSTOWE**

2018

**LED profiles
profile LED**

FLAT8 H/UX

FLAT RECESSED PROFILE EMITTING DIFFUSED LIGHT GLOW

PŁASKI, WPUSTOWY PROFIL EMITUJĄCY ROZPROSZONĄ ŁUNĘ ŚWIATŁA

- decorative and lighting profile
- a parabolic, reflecting element - even, smooth, diffused light
- a flat profile, designed to fit into plasterboards - installation without interference in the frame construction
- mounted to furniture, walls, pedestals with holders (click-in) or directly (with screws, adhesive tape or glue)
- maximum LED strip width: 8 mm
- profil dekoracyjno-oświetleniowy
- paraboliczny odbłyśnik - równomierne, gładkie, rozproszone światło
- płaski profil mieszczący się w grubości płyty karton-gips, montaż bez ingerencji w stelaż zabudowy
- montaż do mebli, ścian, cokołów za pomocą uchwytów (wklikując) lub bezpośrednio (przykręcając lub wklejając)
- maksymalna szerokość taśmy LED: 8 mm



SIMILAR IN THE OFFER / PODOBNE W OFERCIE





H slide cover
klosz H wsuwany

U¹ flexible mounting plate
uchwyt U sprężysty

U² cone U flexible mounting plate
uchwyt U sprężysty cone

X¹ X mounting plate
uchwyt X

X² spring X mounting plate
uchwyt X sprężyna

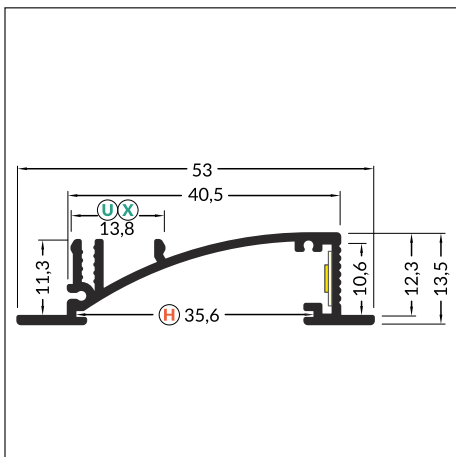
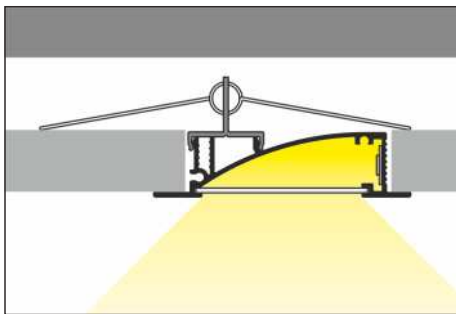
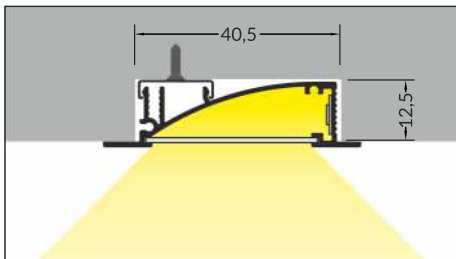
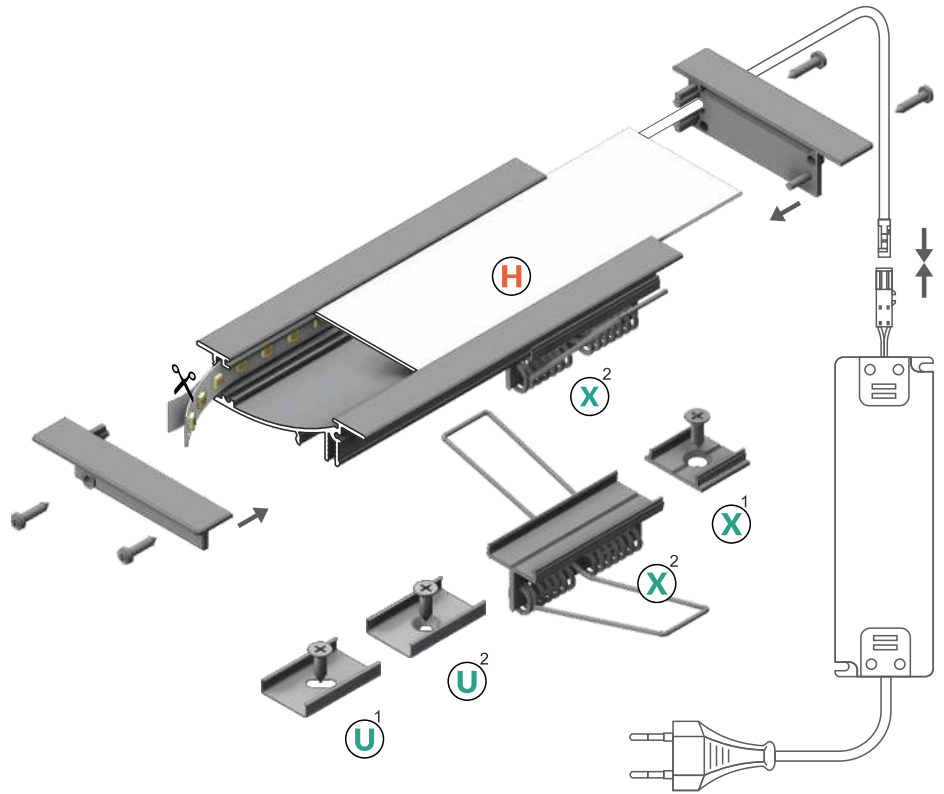

max 8 mm

recessed
wpustowy



INDEX = 1 pc, length 2000 mm
package = 10 pcs
INDEKS = 1 szt., długość 2000 mm
opakowanie = 10 szt.

white painted
biały malowany
23050001

anodized
anodowany
23050020

black anodized
czarny anodowany
23050021

raw aluminium
surowe aluminium
23050000



Available lengths / Dostępne długości
1000 mm, 2000 mm, 3000 mm, 4000 mm



COVERS / KLOSZE

H slide cover
colours: transparent, frosted, white
material: PC, PP, PP

klosz **H** wsuwany
kolory: transparentny, szron, mleczny
materiał: PC, PP, PP



Note! Dimensions of the space to install LED source
Uwaga! Wymiary przestrzeni do zamontowania źródła LED

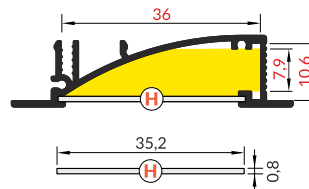

INDEX = 1 pc, length 2000 mm
package = 10 pcs
INDEKS = 1 szt., długość 2000 mm
opakowanie = 10 szt.

H transparent / H transparentny
23080016

H frosted / H szron
23080039

H white / H mleczny
23080038

ENDINGS / ZAŚLEPKI

FLAT8 ending with hole
colours: white, silver, black, grey
material: ABS

zaślepka FLAT8 z otworem
kolory: biały, srebrny, czarny, szary
materiał: ABS

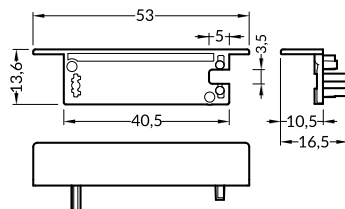

INDEX = 1 set,
package of 10 sets = 20 pcs
INDEKS = 1 komplet, opakowanie
zawiera 10 kompletów = 20 szt.

white
białe 23110001

silver
srebrne 23110040

black
czarne 23110002

grey
szare 23110022

MOUNTINGS / MOCOWANIA

U flexible mounting plate
colour: inox
material: stainless steel

uchwyt **U** sprężysty
kolor: inox
materiał: stal nierdzewna

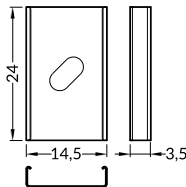
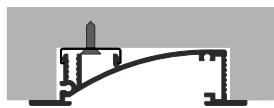

INDEX = 1 set
package of 10 sets = 20 pcs
INDEKS = 1 komplet
opakowanie zawiera 10 kpl = 20 szt

U flexible mounting plate
uchwyt **U** sprężysty

inox
inox 76380000

cone U flexible mounting plate
colour: inox
material: stainless steel

uchwyt **U** sprężysty cone
kolor: inox
materiał: stal nierdzewna

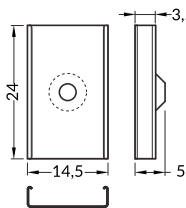
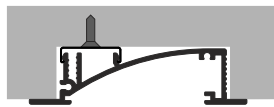

cone U flexible mounting plate
uchwyt **U** sprężysty cone

inox
inox 76620000

X mounting plate
colour: raw aluminium
material: aluminium

uchwyt **X**
kolor: surowe aluminium
materiał: aluminium

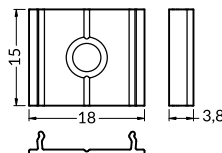
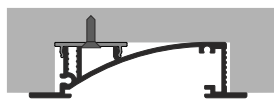

X mounting plate
uchwyt **X**

raw aluminium
surowe aluminium 76260000

spring X mounting plate
colour: raw aluminium
material: aluminium

uchwyt **X** sprężyna
kolor: surowe aluminium
materiał: aluminium

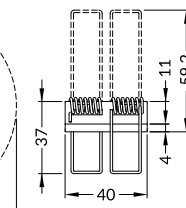
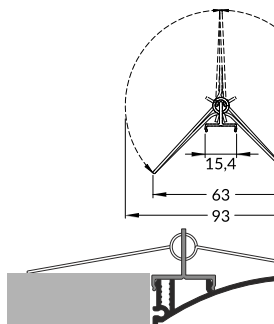

INDEX = 1 pc
INDEKS = 1 szt.

spring X mounting plate
uchwyt **X** sprężyna

raw aluminium
surowe aluminium 23130000



CONNECTORS / ŁĄCZNIKI

X connector 180 deg
colour: raw aluminium
material: aluminium

łącznik X 180 st
kolor: surowe aluminium
materiał: aluminium

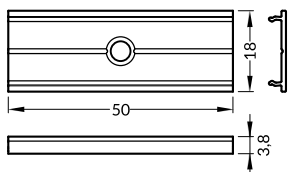

INDEX = 1 set
INDEKS = 1 komplet

raw aluminium
surowe aluminium
76350000

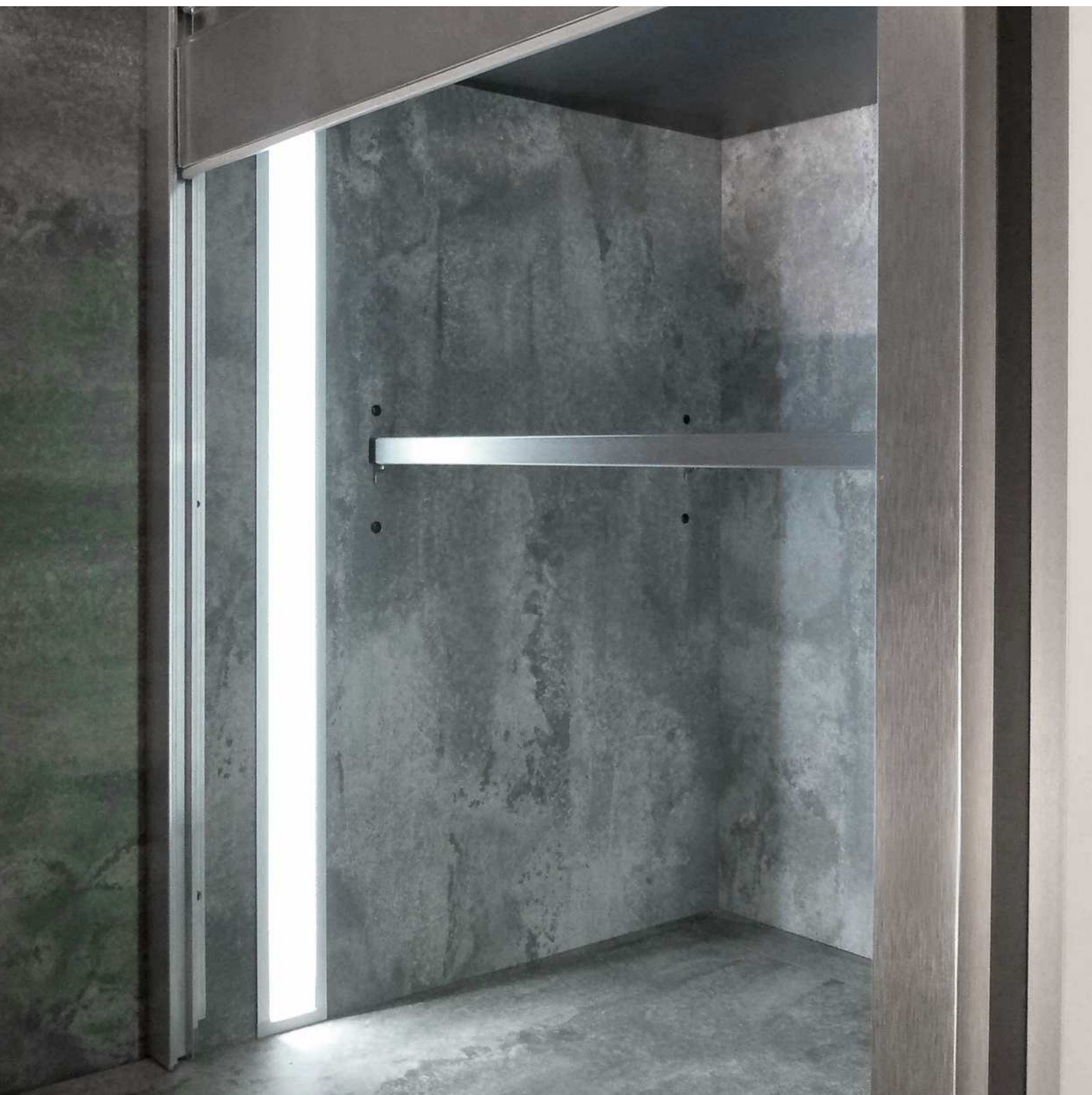

HI8 C1

THIN LINE OF LIGHT

CIENKA LINIA ŚWIATŁA

- for counter edges, steps
- flushes with mounting surface
- only enlight surface of the cover is visible
- miniature dimensions
- maximum width of LED strip: 8 mm
- do montażu w krawędzi blatów, stopni
- zlicowany z powierzchnią montażową
- widoczna tylko świecąca powierzchnia klosza
- miniaturowe gabaryty
- maksymalna szerokość taśmy LED: 8 mm



SIMILAR IN THE OFFER / PODOBNE W OFERCIE



FLOOR12
K/U



SMART-IN10
A/Z



C1 C1 click cover
klosz C1 klik

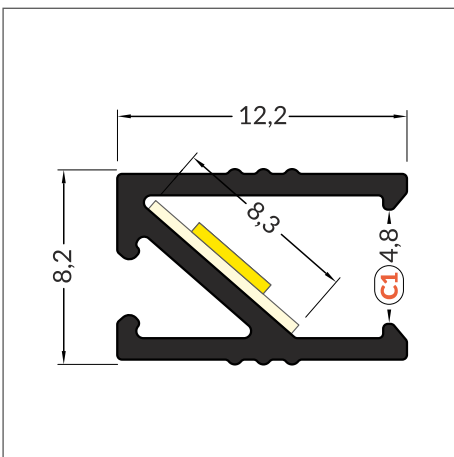
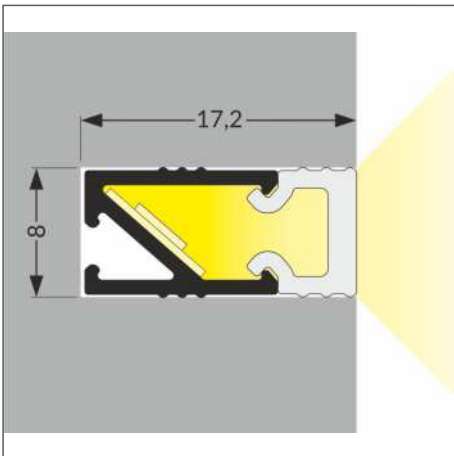
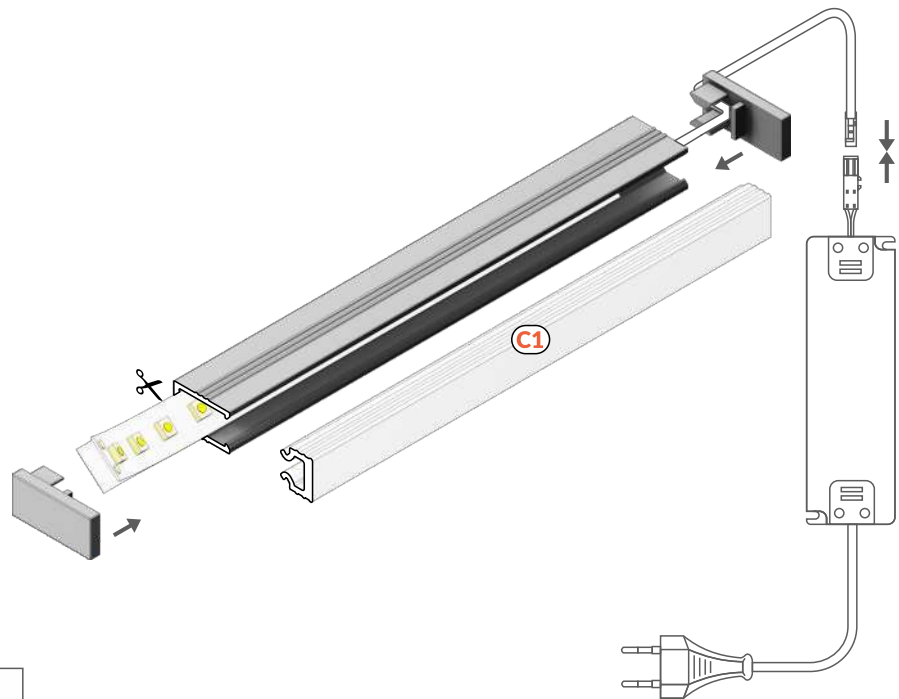

INDEX = 1 pc, length 2000 mm
package = 10 pcs
INDEKS = 1 szt., długość 2000 mm
opakowanie = 10 szt.

● anodized
anodowany
H8020020



max 8 mm



recessed
wpustowy

Available lengths / Dostępne długości
1000 mm, 2000 mm, 3000 mm, 4000 mm

COVERS / KLOSZE

C1 click cover
colour: white
material: PMMA

klosz C1 klik
kolor: mleczny
materiał: PMMA



Note! Dimensions of the space to install LED source
Uwaga! Wymiary przestrzeni do zamontowania źródła LED

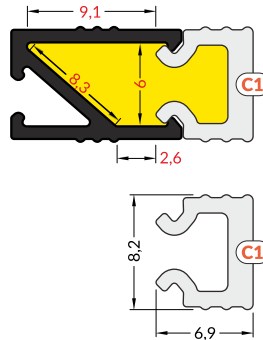

INDEX = 1 pc, length 2000 mm
package = 10 pcs
INDEKS = 1 szt., długość 2000 mm
opakowanie = 10 szt.

C1 white / C1 mleczny
H8060038

ENDINGS / ZAŚLEPKI

H18 ending
colours: silver, grey, white
material: ABS, ABS, PMMA

zaślepka H18
kolory: srebrny, szary, mleczny
materiał: ABS, ABS, PMMA

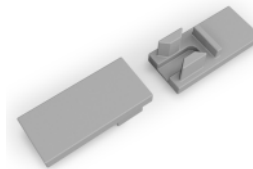
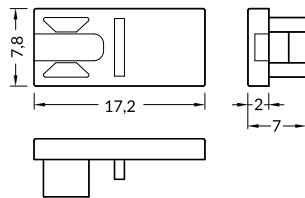

INDEX = 1 set
package of 10 sets = 20 pcs
INDEKS = 1 komplet, opakowanie
zawiera 10 kompletów = 20 szt.

-  silver
srebrne H8990040
-  grey
szare H8990022
-  white
mleczny H8990038



DEEP10 BC/UX

A RECESSED PROFILE WHICH CAN GIVE A CONTINUOUS LINE EFFECT

PROFIL WPUSTOWY Z MOŻLIWOŚCIĄ UZYSKANIA CIĄGŁEJ LINII

- decorative and lighting profile
 - mainly used in furniture or plasterboard
 - continuous line of light (when using LED strip 120 P/m and white cover)
 - angled profile sides are designed for better light reflection
 - maximum LED strip width: 10 mm
-
- profil dekoracyjno-oświetleniowy
 - zastosowanie głównie meblowe lub w płycie karton-gips
 - ciągła linia światła przy użyciu taśmy 120 P/m i klosza mlecznego
 - ścianki profilu ustawione pod kątem działające jak odbłyśnik
 - maksymalna szerokość taśmy LED: 10 mm

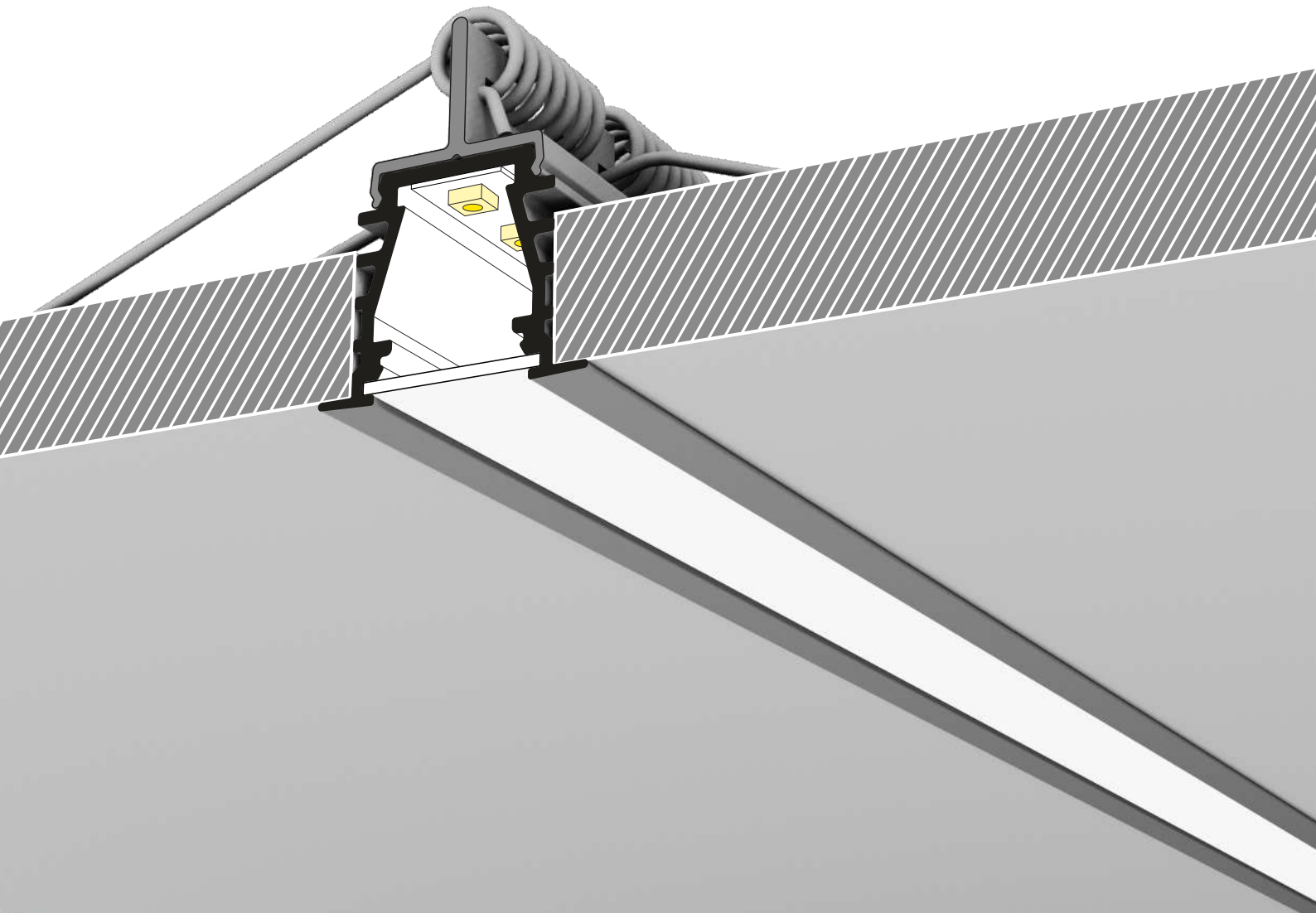

SIMILAR IN THE OFFER / PODOBNE W OFERCIE



FLAT8
H/UX



BEGTIN12
J/S



GROOVE10
BC/UX



UNI12
BCD/U



GROOVE14
EF/TY



B slide cover
klosz B wsuwany

C click cover
klosz C klik

C lens cover
klosz C soczewka

U¹ flexible mounting plate
uchwyt U sprężysty

U² cone **U** flexible mounting plate
uchwyt U sprężysty cone

U³ rack **U** flexible mounting plate
uchwyt U sprężysty rack

X¹ **X** mounting plate
uchwyt X

X² spring **X** mounting plate
uchwyt X sprężyna

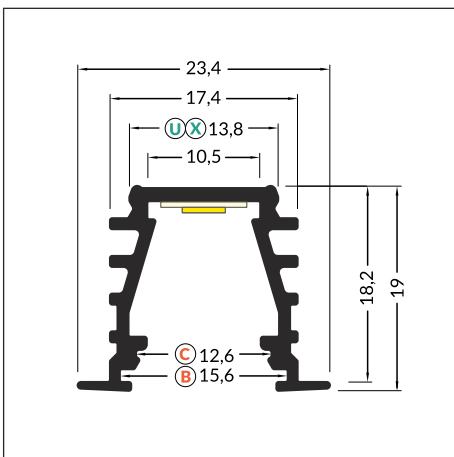
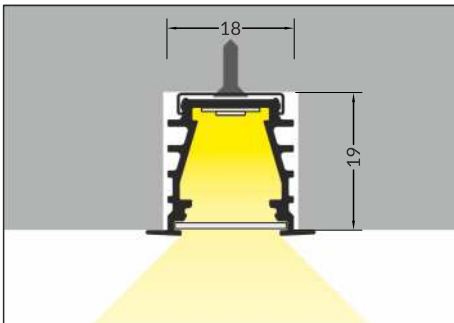
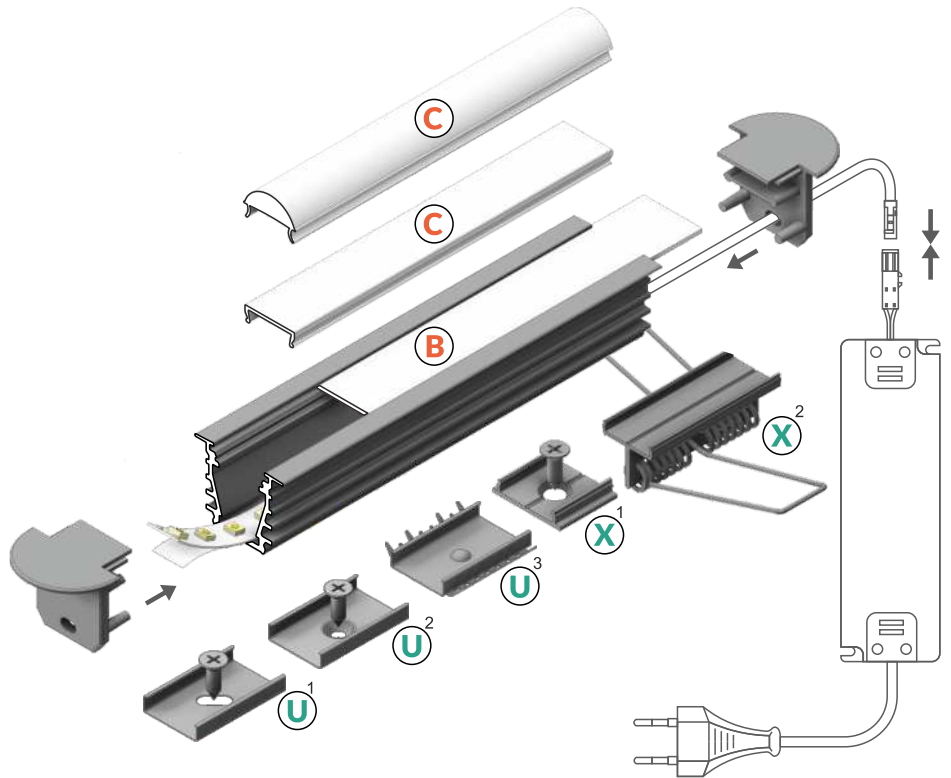

 max 10 mm

 recessed
wpustowy



INDEX = 1 pc, length 2000 mm
package = 10 pcs
INDEKS = 1 szt., długość 2000 mm
opakowanie = 10 szt.

 white painted
biały malowany
96030001

 anodized
anodowany
96030020

 black anodized
czarny anodowany
96030021

 raw aluminium
surowe aluminium
96030000



Available lengths / Dostępne długości
1000 mm, 2000 mm, 3000 mm, 4000 mm



COVERS / KLOSZE

B slide cover

colours: transparent, frosted, white
material: PC, PP, PP

klosz B wsuwany
kolory: transparentny, szron, mleczny
materiał: PC, PP, PP



Note! Dimensions of the space to install LED source
Uwaga! Wymiary przestrzeni do zamontowania źródła LED

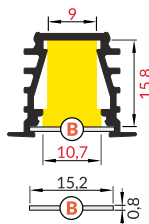

C click cover

colours: transparent, white
material: PMMA

klosz C klik
kolory: transparentny, mleczny
materiał: PMMA

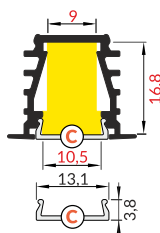

C lens click cover

colour: transparent
material: PC

klosz C klik soczewka
kolor: transparentny
materiał: PC

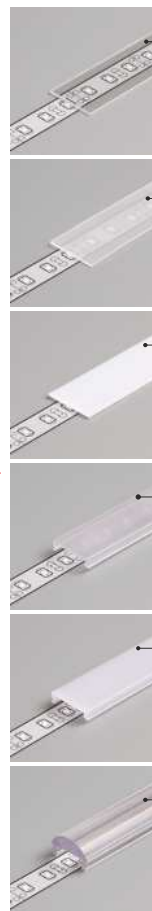
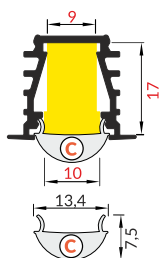

INDEX = 1 pc, length 2000 mm
package = 10 pcs
INDEKS = 1 szt., długość 2000 mm
opakowanie = 10 szt.

B transparent / B transparentny
76250016

B frosted / B szron
76250039

B white / B mleczny
76250038

C transparent / C transparentny
76330000

C white / C mleczny
76330038

C lens / C soczewka
76300000

ENDINGS / ZAŚLEPKI

DEEP10 ending with hole
colours: white, silver, black, grey
material: ABS

zaślepka DEEP10 z otworem
kolory: biały, srebrny, czarny, szary
materiał: ABS

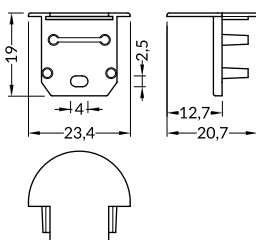

INDEX = 1 set,
package of 10 sets = 20 pcs
INDEKS = 1 komplet, opakowanie
zawiera 10 kompletów = 20 szt.

white
białe 96070001

silver
srebrne 96070040

black
czarne 96070002

grey
szare 96070022

CONNECTORS / ŁĄCZNIKI

X connector 180 deg
colour: raw aluminium
material: aluminium

łącznik X 180 st
kolor: surowe aluminium
materiał: aluminium

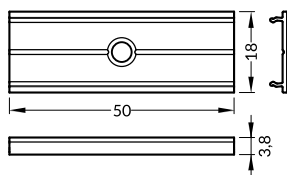

INDEX = 1 set
INDEKS = 1 komplet

raw aluminium
surowe aluminium
76350000



MOUNTINGS / MOCOWANIA

U flexible mounting plate
colour: inox
material: stainless steel

uchwyt U sprężysty
kolor: inox
materiał: stal nierdzewna

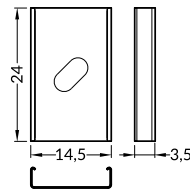
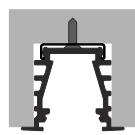

INDEX = 1 set
package of 10 sets = 20 pcs
INDEKS = 1 komplet
opakowanie zawiera 10 kpl = 20 szt

U flexible mounting plate
uchwyt U sprężysty

inox
inox
76380000

cone U flexible mounting plate
colour: inox
material: stainless steel

uchwyt U sprężysty cone
kolor: inox
materiał: stal nierdzewna

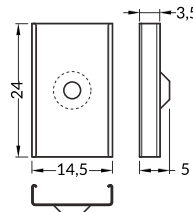

cone U flexible mounting plate
uchwyt U sprężysty cone

inox
inox
76620000

rack U flexible mounting plate
colour: inox
material: stainless steel

uchwyt U sprężysty rack
kolor: inox
materiał: stal nierdzewna

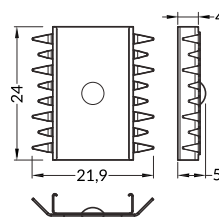

rack U flexible mounting plate
uchwyt U sprężysty rack

inox
inox
76610019

X mounting plate
colour: raw aluminium
material: aluminium

uchwyt X
kolor: surowe aluminium
materiał: aluminium

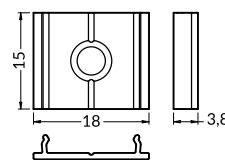

X mounting plate
uchwyt X

raw aluminium
surowe aluminium
76260000

spring X mounting plate
colour: raw aluminium
material: aluminium

uchwyt X sprężyna
kolor: surowe aluminium
materiał: aluminium

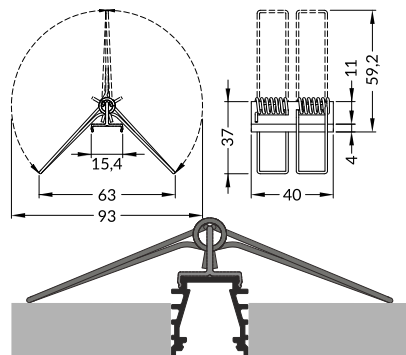

INDEX = 1 pc
INDEKS = 1 szt.

spring X mounting plate
uchwyt X sprężyna

raw aluminium
surowe aluminium
23130000



GROOVE10 BC/UX

RECESSED ALUMINIUM PROFILE

ALUMINIOWY PROFIL WPUSTOWY

- used mainly in furniture
- ceiling installation possible
- decorative and lighting profile
- 6 types of covers
- maximum LED strip width: 10 mm
- głównie do zastosowania meblowego
- możliwe zastosowanie sufitowe
- profil dekoracyjno-oświetleniowy
- 6 rodzajów kloszy
- maksymalna szerokość taśmy LED: 10 mm



SIMILAR IN THE OFFER / PODOBNE W OFERCIE



DEEP10
BC/UX



TRIO10
BC



BEGTIN12
J/S



UNI12
BCD/U



GROOVE14
EF/TY



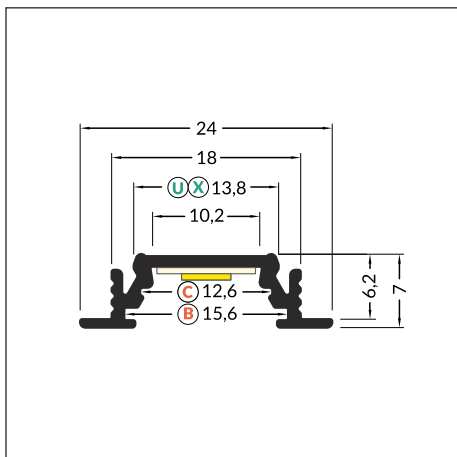
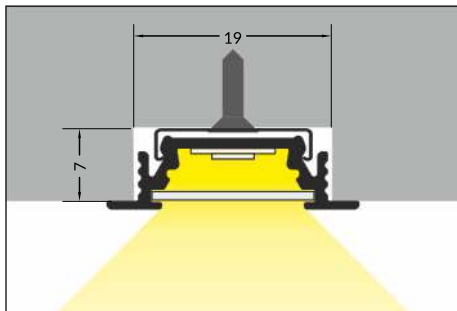
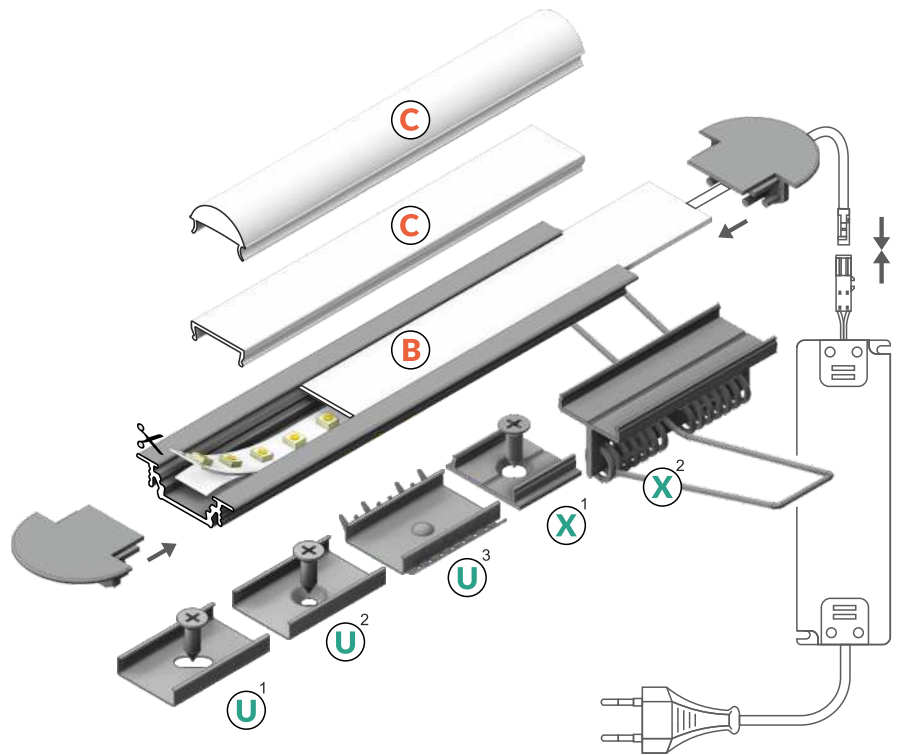

- B** slide cover
klosz B wsuwany
- C** click cover
klosz C klik
- C** lens cover
klosz C soczewka
- U¹** U flexible mounting plate
uchwyt U sprężysty
- U²** cone U flexible mounting plate
uchwyt U sprężysty cone
- U³** rack U flexible mounting plate
uchwyt U sprężysty rack
- X¹** X mounting plate
uchwyt X
- X²** spring X mounting plate
uchwyt X sprężyna



INDEX = 1 pc, length 2000 mm
package = 10 pcs
INDEKS = 1 szt., długość 2000 mm
opakowanie = 10 szt.

 white painted
biały malowany
76210001

 anodized
anodowany
76210020

 black anodized
czarny anodowany
76210021

 raw aluminium
surowe aluminium
76210000

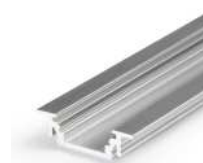

 max 10 mm

 recessed
wpustowy

Available lengths / Dostępne długości
1000 mm, 2000 mm, 3000 mm, 4000 mm



COVERS / KLOSZE

B slide cover

colours: transparent, frosted, white
material: PC, PP, PP

klosz B wsuwany
kolory: transparentny, szron, mleczny
materiał: PC, PP, PP

C click cover

colours: transparent, white
material: PMMA

klosz C klik
kolory: transparentny, mleczny
materiał: PMMA

C click cover lens

colour: transparent
material: PC

klosz C klik soczewka
kolor: transparentny
materiał: PC



Note! Dimensions of the space needed to install LED source
Uwaga! Wymiary przestrzeni do zamontowania źródła LED

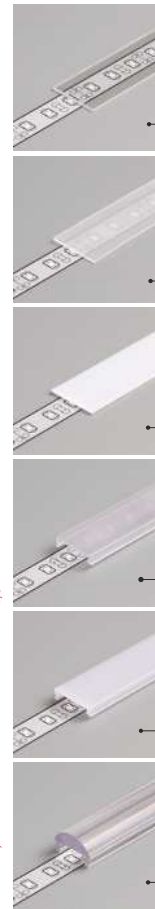
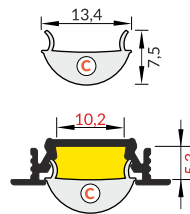
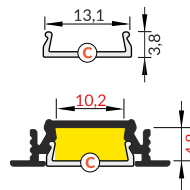
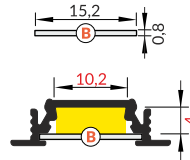

INDEX = 1 pc, length 2000 mm
package = 10 pcs
INDEKS = 1 szt., długość 2000 mm
opakowanie = 10 szt.

B transparent / B transparentny
76250016

B frosted / B szron
76250039

B white / B mleczny
76250038

C transparent / C transparentny
76330000

C white / C mleczny
76330038

C lens / C soczewka
76300000

ENDINGS / ZAŚLEPKI

endings GROOVE10 with hole
colours: white, silver, black, grey
material: ABS

zaślepka GROOVE10 z otworem
kolory: biały, srebrny, czarny, szary
materiał: ABS

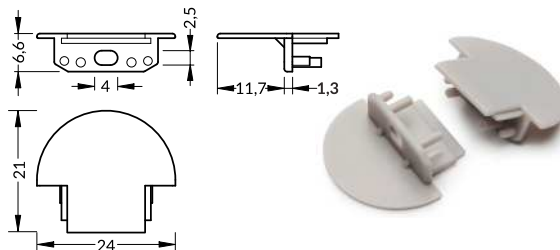

INDEX = 1 set,
package of 10 sets = 20 pcs
INDEKS = 1 komplet, opakowanie
zawiera 10 kompletów = 20 szt.

- white
białe 76480001
- silver
srebrne 76480040
- black
czarne 76480002
- grey
szare 76480022

CONNECTORS / ŁĄCZNIKI

X connector 180 deg
colour: raw aluminium
material: aluminium

łącznik X 180 st
kolor: surowe aluminium
materiał: aluminium

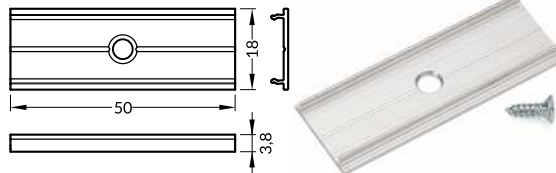

GROOVE10 connector 90 deg
colours: white, anodized, black
material: aluminium

łącznik GROOVE10 90 st
kolory: biały, anodowany, czarny
materiał: aluminium

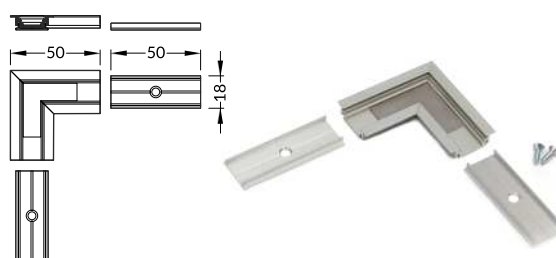

INDEX = 1 set
INDEKS = 1 komplet

X connector
łącznik X

raw aluminium
surowe aluminium
76350000

L connector
łącznik L

white painted
biały malowany
76530001

anodized
anodowany
76530020

black anodized
czarny anodowany
76530021



MOUNTINGS / MOCOWANIA

U flexible mounting plate
colours: inox
material: stainless steel

uchwyt U sprężysty
kolory: inox
materiał: stal nierdzewna

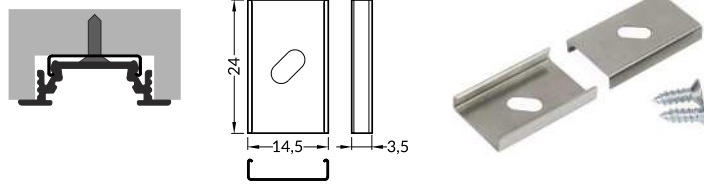

INDEX = 1 set
package of 10 sets = 20 pcs
INDEKS = 1 komplet
opakowanie zawiera 10 kpl = 20 szt

U flexible mounting plate
uchwyt U sprężysty

 inox 76380000

cone U flexible mounting plate
colours: inox
material: stainless steel

uchwyt U sprężysty cone
kolory: inox
materiał: stal nierdzewna

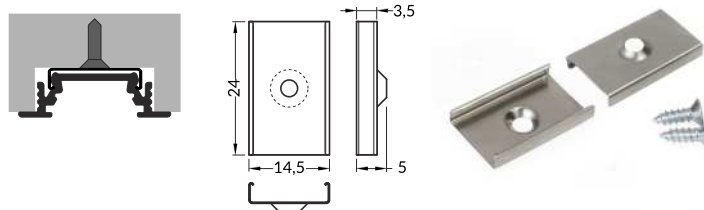

cone U flexible mounting plate
uchwyt U sprężysty cone

 inox 76620000

rack U flexible mounting plate
colours: inox
material: stainless steel

uchwyt U sprężysty rack
kolory: inox
materiał: stal nierdzewna

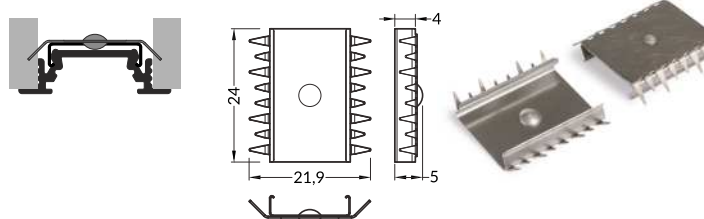

rack U flexible mounting plate
uchwyt U sprężysty rack

 inox 76610019

X mounting plate
colours: raw aluminium
material: aluminium

uchwyt X
kolory: surowe aluminium
materiał: aluminium

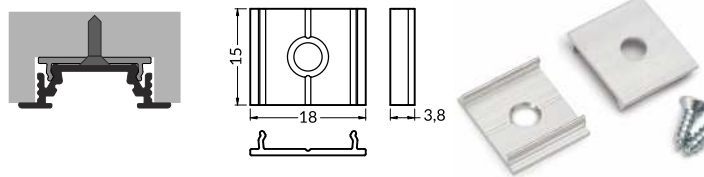

X mounting plate
uchwyt X

 raw aluminium
surowe aluminium
76260000

spring X mounting plate
colours: raw aluminium
material: aluminium

uchwyt X sprężyna
kolory: surowe aluminium
materiał: aluminium

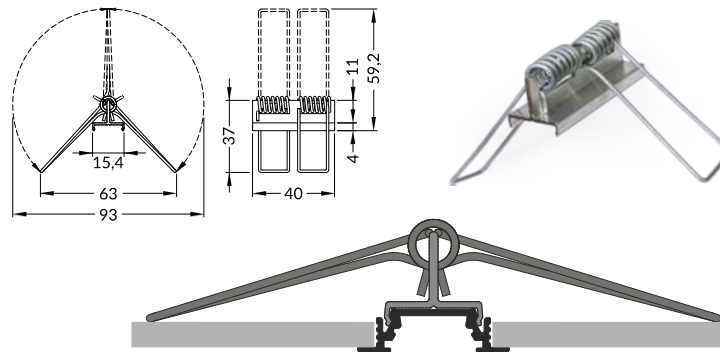

INDEX = 1 pc
INDEKS = 1 szt.

spring X mounting plate
uchwyt X sprężyna

 raw aluminium
surowe aluminium
23130000



CONTINUOUS LIGHT LINE IN SMALL RECESSED PROFILE

CIĄGŁA LINIA ŚWIATŁA W MAŁYM PROFILU WPUSTOWYM

- suitable for use in plasterboards - does not affect the structure of the board
- used also in furniture
- continuous line of light (when using LED strip 120 p/m and white cover)
- SLICK socket
- miniature dimensions
- maximum width of LED strip: 10 mm

- do zastosowania w płycie gipsowo-kartonowej - nie narusza konstrukcji płyty
- również do zastosowania meblowego
- ciągła linia światła (przy zastosowaniu taśmy 120 P/m i klosza mlecznego)
- gniazdo Slick
- miniaturowe gabaryty
- maksymalna szerokość taśmy LED: 10 mm



SIMILAR IN THE OFFER / PODOBNE W OFERCIE



DEEP10
BC/UX



SMART10
A/Z



GROOVE10
BC/UX



BEGTIN12
J/S



UNI12
BCD/U



GROOVE14
EF/TY



- A** slide cover
klosz A wsuwany
- Z**¹ flexible mounting plate
uchwyt Z sprężysty
- Z**² cone Z flexible mounting plate
uchwyt Z sprężysty cone

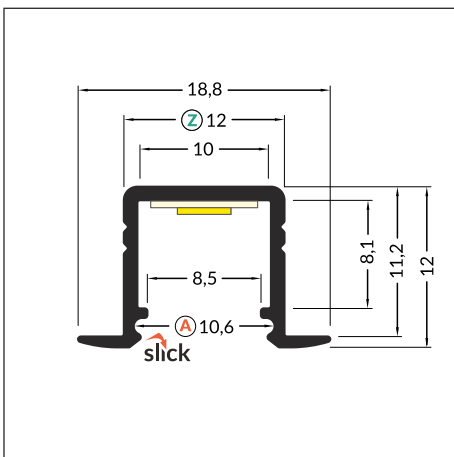
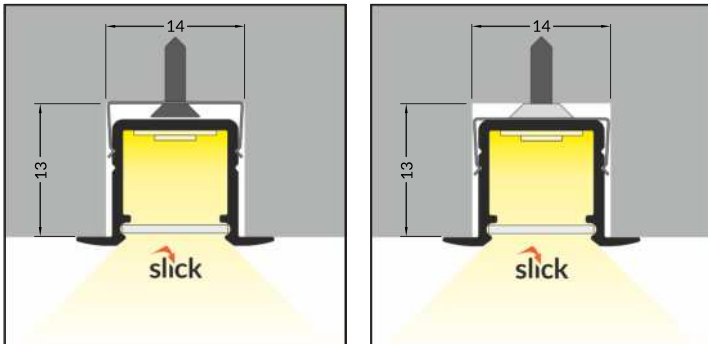
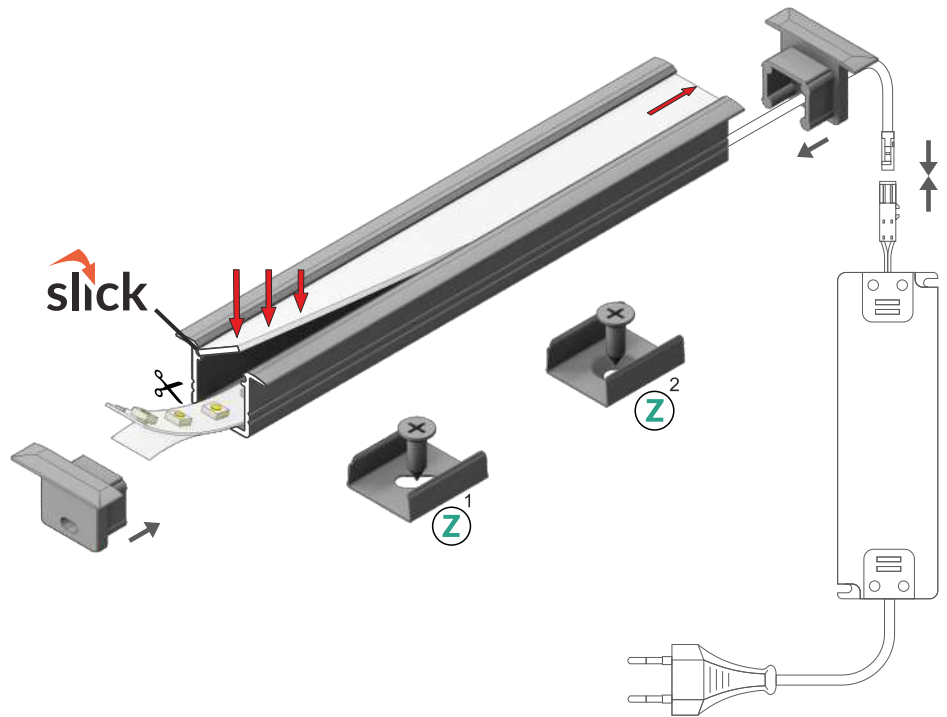

○ white painted
biały malowany
E3020001



● anodized
anodowany
E3020020



● black anodized
czarny anodowany
E3020021



○ raw aluminium
surowe aluminium
E3020000

max 10 mm

recessed
wpustowy

Available lengths / Dostępne długości
1000 mm, 2000 mm, 3000 mm, 4000 mm



COVERS / KLOSZE

A slide cover
colours: transparent, frosted, white
material: PC, PP, PP

klosz **A** wsuwany
kolory: przezroczysty, szron, mleczny
materiał: PC, PP, PP



Note! Dimensions of the space to install LED source
Uwaga! Wymiary przestrzeni do zamontowania źródła LED

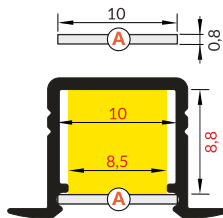

INDEX = 1 pc, length 2000 mm
package = 10 pcs
INDEKS = 1 szt., długość 2000 mm
opakowanie = 10 szt.

A transparent / A przezroczysty
89070016

A frosted / A szron
89070039

A white / A mleczny
89070038

ENDINGS / ZAŚLEPKI

SMART-IN10 ending with hole
colours: white, silver, black, grey
material: ABS

zaślepka SMART-IN10 z otworem
kolory: biały, srebrny, czarny, szary
materiał: ABS

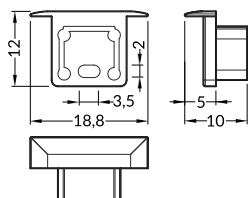

INDEX = 1 set
package of 10 sets = 20 pcs
INDEKS = 1 komplet, opakowanie
zawiera 10 kompletów = 20 szt.

- white biały E3990001
- silver srebrny E3990040
- black czarny E3990002
- grey szary E3990022

MOUNTINGS / MOCOWANIA

Z flexible mounting plate
colours: white, inox, black
material: stainless steel

uchwyt **Z** sprężysty
kolory: biały, inox, czarny
materiał: stal nierdzewna

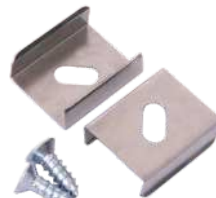
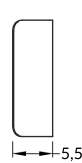
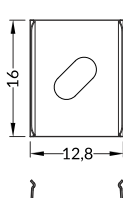
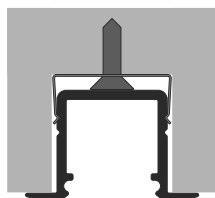

INDEX = 1 set
package of 10 sets = 20 pcs
INDEKS = 1 komplet
opakowanie zawiera 10 kpl = 20 szt

Z flexible mounting plate
uchwyt **Z** sprężysty

- white biały 89270001
- inox 89270019
- black czarny 89270002

cone Z flexible mounting plate
colours: white, inox, black
material: stainless steel

uchwyt **Z** sprężysty cone
kolory: biały, inox, czarny
materiał: stal nierdzewna

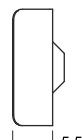
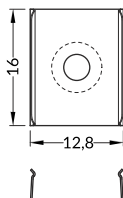
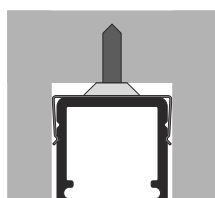

cone **Z** flexible mounting plate
uchwyt **Z** sprężysty cone

- white biały 89980001
- inox 89980019
- black czarny 89980002



BEGTIN12 J/S



SMALL RECESSED ALUMINIUM PROFILE

MAŁY ALUMINIOWY PROFIL WPUSTOWY

- decorative and lighting profile
- light weight, budget profile
- used mainly in furniture
- Slick socket
- maximum LED strip width: 12 mm
- profil dekoracyjno-oświetleniowy
- lekki profil budżetowy
- głównie do zastosowania meblowego
- gniazdo z funkcją Slick
- maksymalna szerokość taśmy LED: 12 mm



SIMILAR IN THE OFFER / PODOBNE W OFERCIE



DEEP10
BC/UX



GROOVE10
BC/UX



SMART-IN10
A/Z



BEGTON12
J/S



- J** slide cover
klosz J wsuwany
- S¹** flexible mounting plate
uchwyt S sprężysty
- S²** cone S flexible mounting plate
uchwyt S sprężysty cone

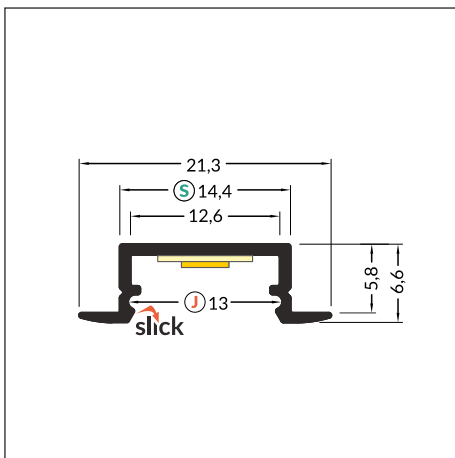
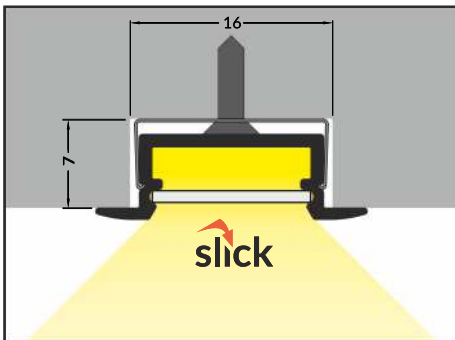
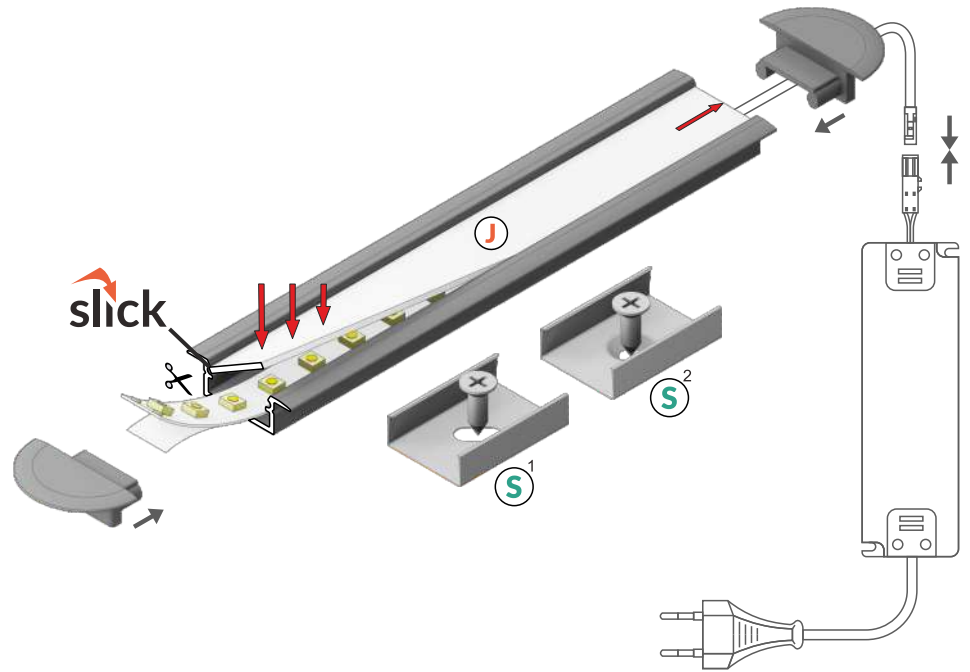

INDEX = 1 pc, length 2000 mm
package = 10 pcs
INDEKS = 1 szt., długość 2000 mm
opakowanie = 10 szt.

 white painted
biały malowany
C8020001

 anodized
anodowany
C8020020

 black anodized
czarny anodowany
C8020021

 raw aluminium
surowe aluminium
C8020000

 max 12 mm

 recessed
wpustowy

Available lengths / Dostępne długości
1000 mm, 2000 mm, 3000 mm, 4000 mm



COVERS / KLOSZE

J slide cover

colours: transparent, frosted, white
material: PC, PP, PP

klosz J wsuwany

kolory: transparentny, szron, mleczny
materiał: PC, PP, PP



Note! Dimensions of the space to install LED source
Uwaga! Wymiary przestrzeni do zamontowania źródła LED

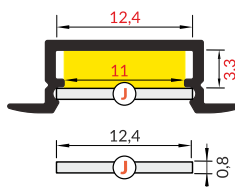

INDEX = 1 pc, length 2000 mm
package = 10 pcs
INDEKS = 1 szt., długość 2000 mm
opakowanie = 10 szt.

J transparent / J transparentny
70330016

J frosted / J szron
70330039

J white / J mleczny
70330038

ENDINGS / ZAŚLEPKI

BEGTIN12 ending with hole

colours: white, silver, black, grey
material: ABS

zaślepka BEGTIN12 z otworem

kolory: biały, srebrny, czarny, szary
materiał: ABS

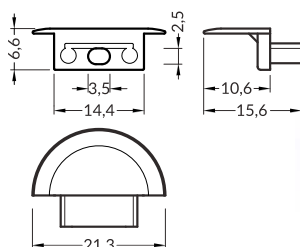

INDEX = 1 set
package of 10 sets = 20 pcs
INDEKS = 1 komplet, opakowanie
zawiera 10 kompletów = 20 szt.

white
białe C8980001

silver
srebrne C8980040

black
czarne C8980002

grey
szare C8980022

MOUNTINGS / MOCOWANIA

S flexible mounting plate

colours: white, inox, black
material: stainless steel

uchwyt S sprężysty

kolory: biały, inox, czarny
materiał: stal nierdzewna

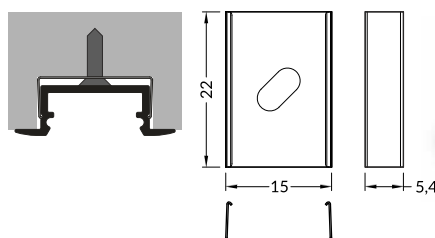

INDEX = 1 set
package of 10 sets = 20 pcs
INDEKS = 1 komplet, opakowanie
zawiera 10 kompletów = 20 szt.

white
biały C7980001

inox
inox C7980019

black
czarny C7980002

cone S flexible mounting plate

colours: white, inox, black
material: stainless steel

uchwyt S sprężysty cone

kolory: biały, inox, czarny
materiał: stal nierdzewna

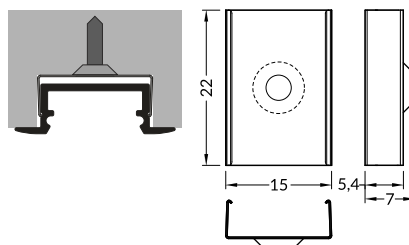

white
biały C7950001

inox
inox C7950019

black
czarny C7950002



FLOOR12 K/U

RECESSED FLOOR PROFILE

PROFIL WPUSTOWY DO PODŁÓG

- decorative and lighting profile
- high abrasion resistance, resistant cover
- possibility of waterproof
- with high humidity, please use waterproof tape
- maximum LED strip width: 12 mm
- profil dekoracyjno-oświetleniowy
- wysoka odporność na ścieranie, wytrzymały klosz
- możliwość uzyskania wodoszczelności
- przy podwyższonej wilgotności stosować taśmę wodoodporną
- maksymalna szerokość taśmy LED: 12 mm



SIMILAR IN THE OFFER / PODOBNE W OFERCIE



STEP10
C



OUTSTAIRS12
BC



DEEP10
BC/UX



UNI12
BCD/U



- K** **K click cover**
klosz K klik
- U**¹ **U flexible mounting plate**
uchwyt U sprężysty
- U**² **cone U flexible mounting plate**
uchwyt U sprężysty cone

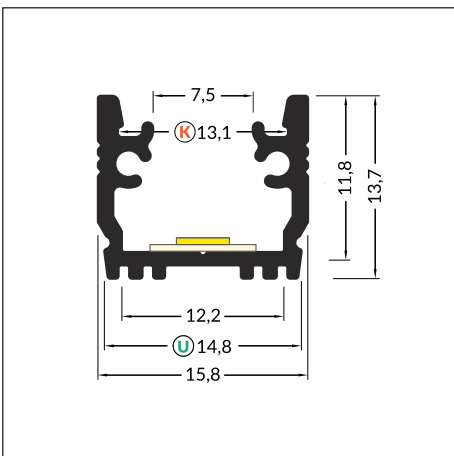
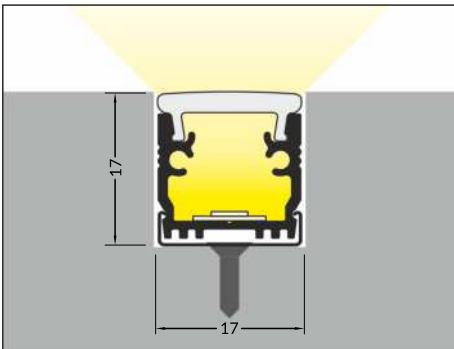
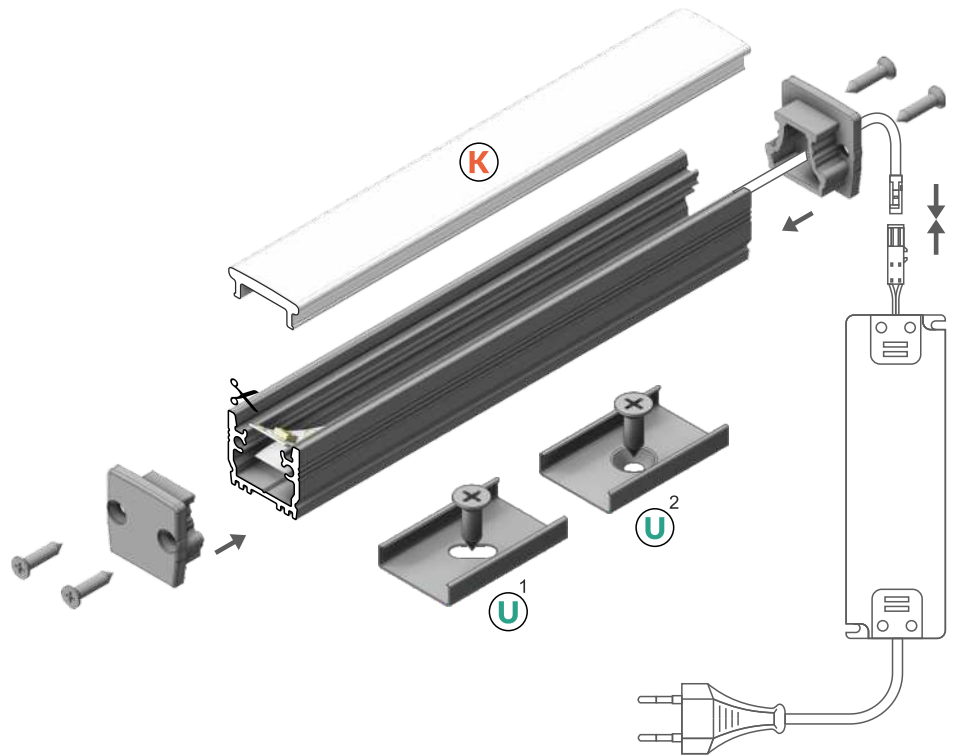

INDEX = 1 pc, length 2000 mm
package = 10 pcs
INDEKS = 1 szt., długość 2000 mm
opakowanie = 10 szt.

 anodized
anodowany
B1020020

Available lengths / Dostępne długości
1000 mm, 2000 mm, 3000 mm, 4000 mm



max 12 mm



recessed
wpustowy



IK08 (5 J)



↓ 5 J

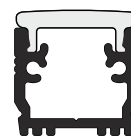



COVERS / KLOSZE

K click cover
colour: white
material: PC

klosz **K** klik
kolor: mleczny
materiał: PC

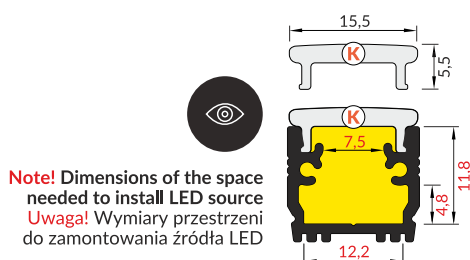

INDEX = 1 pc, length 2000 mm
package = 10 pcs
INDEKS = 1 szt., długość 2000 mm
opakowanie = 10 szt.

K white / K mleczny
B1040038

ENDINGS / ZAŚLEPKI

FLOOR12 ending
colours: silver, grey
material: ABS

zaślepka FLOOR12
kolory: srebrny, szary
materiał: ABS

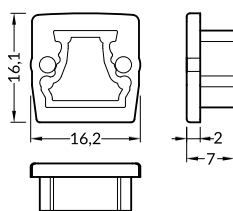

INDEX = 1 set
package of 10 sets = 20 pcs
INDEKS = 1 komplet, opakowanie
zawiera 10 kompletów = 20 szt.

● silver
srebrne

with hole
z otworem
B1960040

without hole
bez otworu
B1940040

● grey
szare

with hole
z otworem
B1960022

without hole
bez otworu
B1940022

FLOOR12 ending with hole
colours: silver, grey
material: ABS

zaślepka FLOOR12 z otworem
kolory: srebrny, szary
materiał: ABS

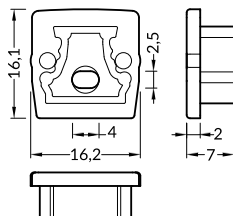

MOUNTINGS / MOCOWANIA

U flexible mounting plate
colour: inox
material: stainless steel

uchwyt **U** sprężysty
kolor: inox
materiał: stal nierdzewna

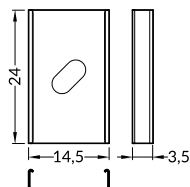
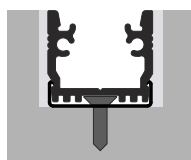

INDEX = 1 set
package of 10 sets = 20 pcs
INDEKS = 1 komplet
opakowanie zawiera 10 kpl = 20 szt

U flexible mounting plate
uchwyt **U** sprężysty

● inox
inox
76380000

cone U flexible mounting plate
colour: inox
material: stainless steel

uchwyt **U** sprężysty cone
kolor: inox
materiał: stal nierdzewna

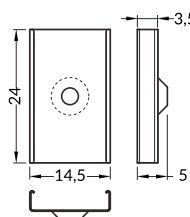
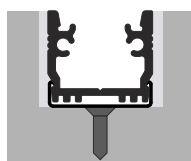

cone **U** flexible mounting plate
uchwyt **U** sprężysty cone

● inox
inox
76620000

SEALING / USZCZELKA

sealings for FLOOR12 endings
2x silicone sealings
4x rubber o-ring

uszczelki do zaślepki FLOOR12
2x silikonowa uszczelka
4x gumowa uszczelka o-ring



In high humidity conditions
use waterproof tape and silicone seal
Przy podwyższonej wilgotności zaleca się
użycie zestawu uszczelniającego
i wodoodpornej taśmy.



INDEX = 1 set
INDEKS = 1 komplet

sealing set
zestaw uszczelniający
B1830000



GROOVE14 EF/TY

BASIC ALUMINIUM RECESSED PROFILE

PODSTAWOWY, ALUMINIOWY PROFIL WPUSTOWY

- decorative and lighting profile
- used mainly in furniture
- maximum LED strip width: 14 mm
- profil dekoracyjno-oświetleniowy
- głównie do zastosowania meblowego
- maksymalna szerokość taśmy LED: 14 mm



SIMILAR IN THE OFFER / PODOBNE W OFERCIE





E **E** slide cover
klosz **E** wsuwany

F **F** click cover
klosz **F** klik

E7 **E7** click cover
klosz **E7** klik

Y¹ **Y** flexible mounting plate
uchwyt **Y** sprężysty

Y² **cone Y** flexible mounting plate
uchwyt **Y** sprężysty cone

T **T** mounting plate
uchwyt **T**

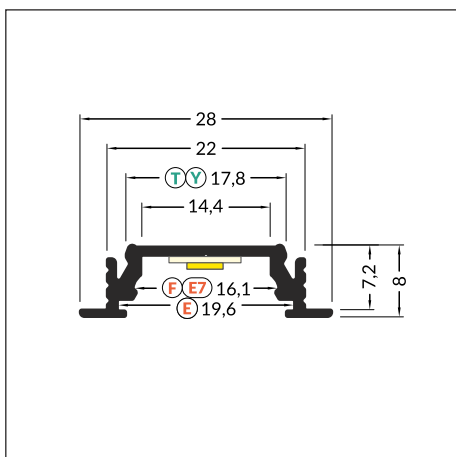
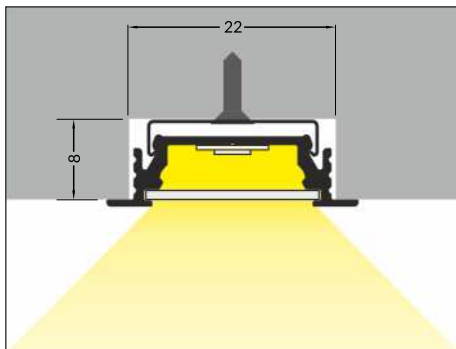
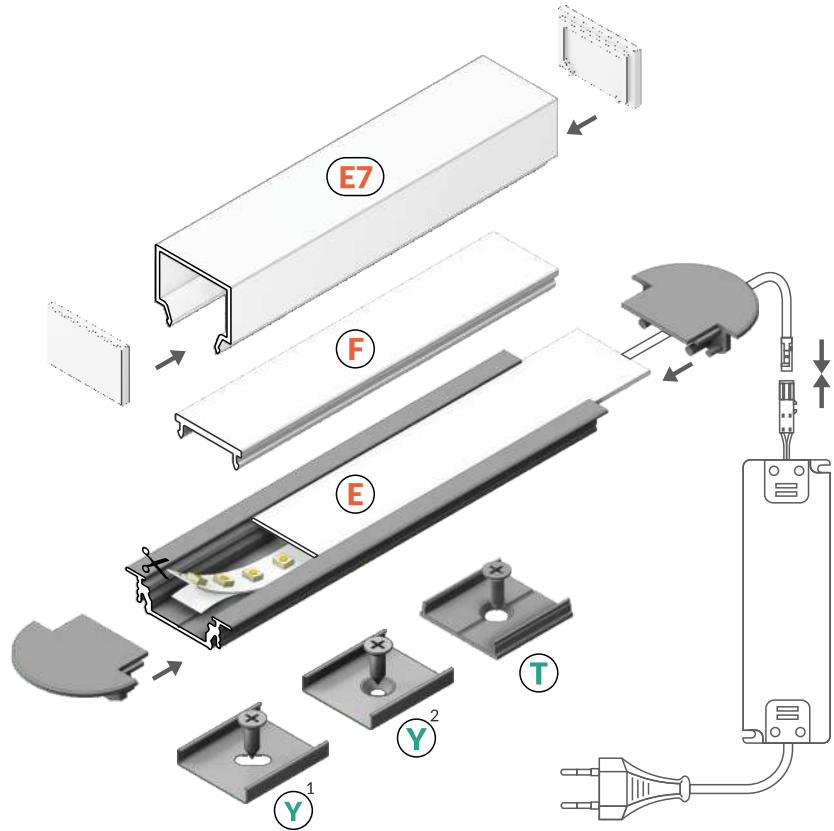

white painted
biały malowany
A3020001



anodized
anodowany
A3020020



black anodized
czarny anodowany
A3020021



raw aluminium
surowe aluminium
A3020000

max 14 mm

recessed
wpustowy

Available lengths / Dostępne długości
1000 mm, 2000 mm, 3000 mm, 4000 mm



COVERS / KLOSZE

E slide cover
colours: transparent, frosted, white
material: PC, PP, PP

klosz E wsuwany
kolory: transparentny, szron, mleczny
materiał: PC, PP, PP



Note! Dimensions of the space to install LED source
Uwaga! Wymiary przestrzeni do zamontowania źródła LED

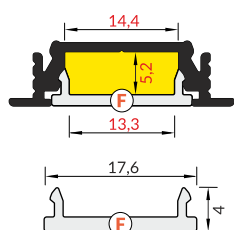
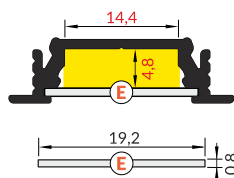

F click cover
colours: transparent, white
material: PMMA

klosz F klik
kolory: transparentny, mleczny
materiał: PMMA

E7 click cover
colour: white
material: PMMA

klosz E7 klik
kolor: mleczny
materiał: PMMA

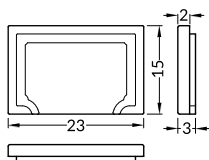
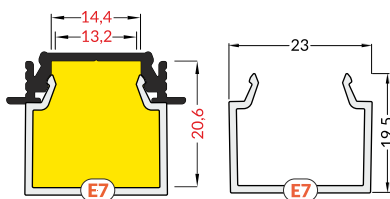

INDEX = 1 pc, length 2000 mm
package = 10 pcs
INDEKS = 1 szt., długość 2000 mm
opakowanie = 10 szt.

E transparent / E transparentny
A2040016

E frosted / E szron
A2040039

E white / E mleczny
A2040038

F transparent / F transparentny
A2060016

F white / F mleczny
A2060038

E7 white / E7 mleczny
C1080038

INDEX = 1 set
package of 10 sets = 20 pcs
INDEKS = 1 komplet, opakowanie
zawiera 10 kompletów = 20 szt.

E7 white ending
zaślepka E7 mleczny
C1840038

MOUNTINGS / MOCOWANIA

Y flexible mounting plate
colour: inox
material: stainless steel

uchwyt Y sprężysty
kolor: inox
materiał: stal nierdzewna

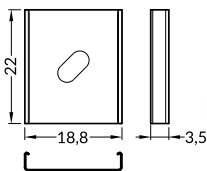
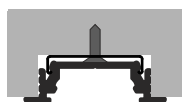

cone Y flexible mounting plate
colour: inox
material: stainless steel

uchwyt Y sprężysty cone
kolor: inox
materiał: stal nierdzewna

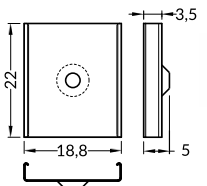

T mounting plate
colour: raw aluminium
material: aluminium

uchwyt T
kolor: surowe aluminium
materiał: aluminium

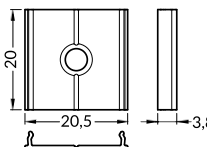
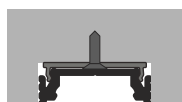

INDEX = 1 set
package of 10 sets = 20 pcs
INDEKS = 1 komplet, opakowanie
zawiera 10 kompletów = 20 szt.

Y flexible mounting plate
uchwyt Y sprężysty

inox
inox A2090019

cone Y flexible mounting plate
uchwyt Y sprężysty cone

inox
inox A2130019

T mounting plate
uchwyt T

raw aluminium
surowe aluminium
C6960000



ENDINGS / ZAŚLEPKI

GROOVE14 ending with hole
colours: white, silver, black, grey
material: ABS

zaślepka GROOVE14 z otworem
kolory: biały, srebrny, czarny, szary
materiał: ABS

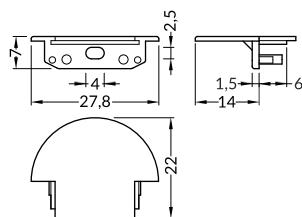

INDEX = 1 set
package of 10 sets = 20 pcs
INDEKS = 1 komplet, opakowanie
zawiera 10 kompletów = 20 szt.

-  white
białe A3100001
-  silver
srebrne A3100040
-  black
czarne A3100002
-  grey
szare A3100022

CONNECTORS / ŁĄCZNIKI

T connector 180 deg
colour: raw aluminium
material: aluminium

łącznik T 180 st
kolor: surowe aluminium
materiał: aluminium

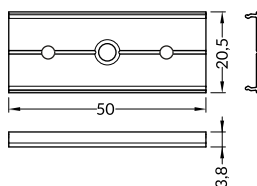

GROOVE14 connector 90 deg
colours: white, anodized, black
material: aluminium

łącznik GROOVE14 90 st
kolory: biały, anodowany, czarny
materiał: aluminium

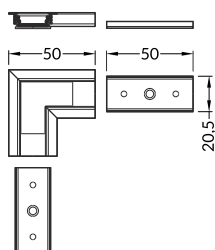



INDEX = 1 set
INDEKS = 1 komplet

T connector / łącznik T

 raw aluminium
surowe aluminium
C6990000

connector 90 deg / łącznik 90 st

-  white painted
biały malowany
A3990001
-  anodized
anodowany
A3990020
-  black anodized
czarny anodowany
A3990021



LINEA-IN20 EF/U7

CREATING LIGHTING PATTERNS THANKS TO ANGULAR CONNECTORS

KSZTAŁTOWANIE WZORÓW ŚWIETLNYCH DZIĘKI ŁĄCZNIKOM KĄTOWYM

- recessed, lighting profile - dedicated to medium-voltage light sources
 - continuous line of light (when using LED strip 120 P/m and white cover)
 - angled connections illuminated
 - 20 accessories available
 - 3 mounting options of LED modules: thermic tape, LED module on a strip, additionally LED clamp
 - maximum LED source width: 20 mm
- wpustowy profil oświetleniowy - przeznaczony do źródeł światła o średniej mocy
 - ciągła linia światła (przy użyciu taśm 120 P/m oraz klosza mlecznego)
 - świecące połączenia kątowe
 - 20 akcesoriów
 - 3 sposoby mocowania modułów LED: taśmą termiczną, moduł na taśmie, dodatkowo docisk LED
 - maksymalna szerokość źródła LED: 20 mm

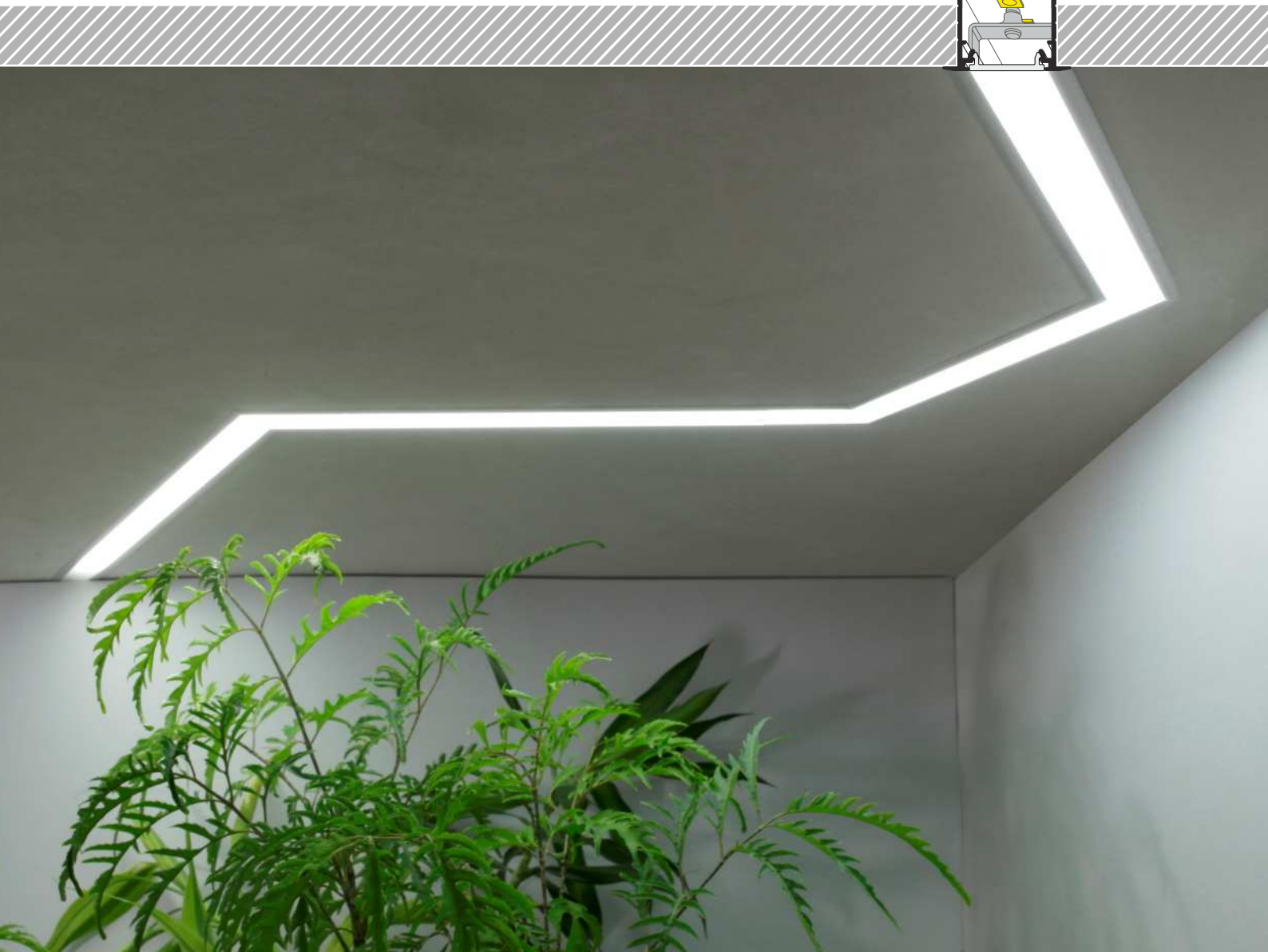
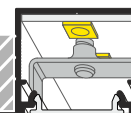

SIMILAR IN THE OFFER / PODOBNE W OFERCIE





- E** slide cover
klosz E wsuwany
- F** click cover
klosz F klik
- E7** click cover
klosz E7 klik
- U7**¹ U7 mounting plate
uchwyt U7
- U7**² cone U7 mounting plate
uchwyt U7 cone
- U7**³ rack U7 mounting plate
uchwyt U7 rack
- U7**⁴ spring U7 mounting plate
uchwyt U7 sprężyna

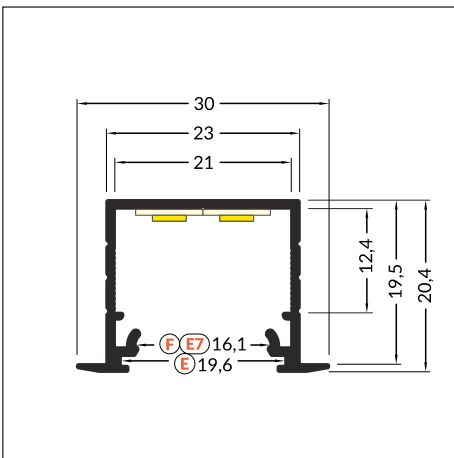
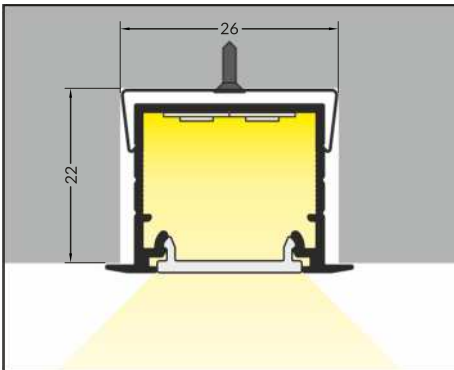
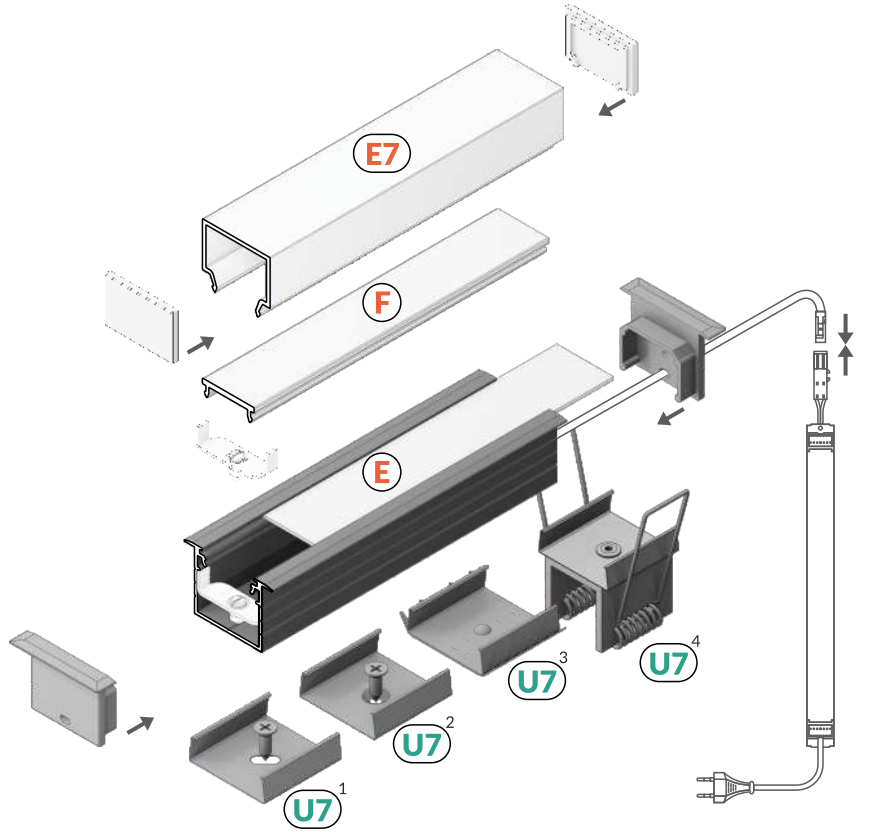

○ white painted
biały malowany
E4020001



● anodized
anodowany
E4020020



● black anodized
czarny anodowany
E4020021



○ raw aluminium
surowe aluminium
E4020000



Available lengths / Dostępne długości
1000 mm, 2000 mm, 3000 mm, 4000 mm



COVERS / KLOSZE

E slide cover
colours: transparent, frosted, white
material: PC, PP, PP

klosz **E** wsuwany
kolory: transparentny, szron, mleczny
materiał: PC, PP, PP



Note! Dimensions of the space to install LED source
Uwaga! Wymiary przestrzeni do zamontowania źródła LED

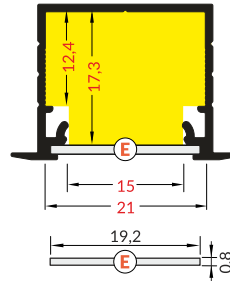

INDEX = 1 pc, length 2000 mm
package = 10 pcs
INDEKS = 1 szt., długość 2000 mm
opakowanie = 10 szt.

E transparent / E transparentny
A2040016

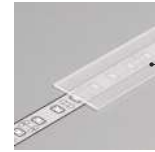

E frosted / E szron
A2040039

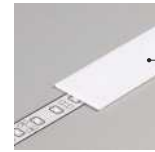

E white / E mleczny
A2040038



F transparent / F transparentny
A2060016

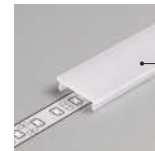

F white / F mleczny
A2060038

F click cover
colours: transparent, white
material: PMMA

klosz **F** klik
kolory: transparentny, mleczny
materiał: PMMA

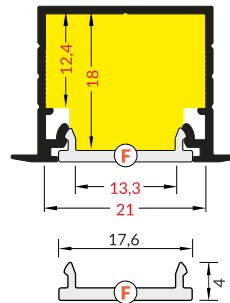

E7 click cover
colour: white
material: PMMA

klosz **E7** klik
kolor: mleczny
materiał: PMMA

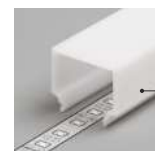
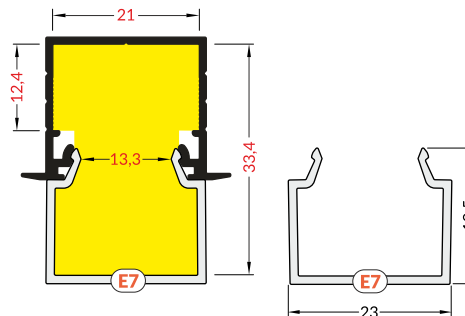

E7 white / E7 mleczny
C1080038

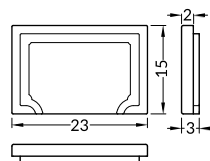

INDEX = 1 set
package of 10 sets = 20 pcs
INDEKS = 1 komplet, opakowanie
zawiera 10 kompletów = 20 szt.

E7 white ending
zaślepka **E7** mleczny
C1840038

ENDINGS / ZAŚLEPKI

LINEA-IN20 ending with hole
colours: white, silver, black, grey
material: ABS

zaślepka LINEA-IN20 z otworem
kolory: biały, srebrny, czarny, szary
materiał: ABS

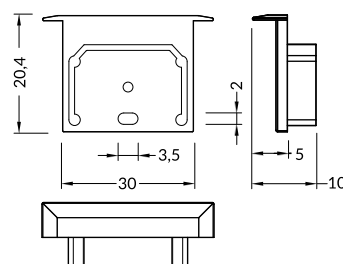

INDEX = 1 set
package of 10 sets = 20 pcs
INDEKS = 1 komplet, opakowanie
zawiera 10 kompletów = 20 szt.

-  white biały E4990001
-  silver srebrne E4990040
-  black czarny E4990002
-  grey szare E4990022



MOUNTINGS / MOCOWANIA

U7 mounting plate
colour: inox
material: stainless steel

uchwyt **U7**
kolor: inox
materiał: stal nierdzewna

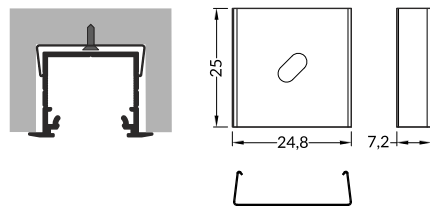

INDEX = 1 set
package of 10 sets = 20 pcs
INDEKS = 1 komplet, opakowanie
zawiera 10 kompletów = 20 szt.

U7 mounting plate
uchwyt **U7**

 inox
E4960019

cone U7 mounting plate
colour: inox
material: stainless steel

uchwyt **U7** cone
kolor: inox
materiał: stal nierdzewna

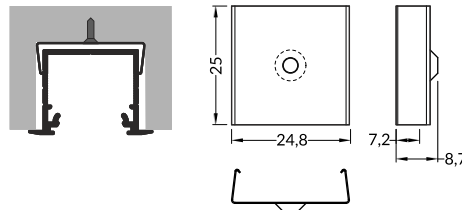

cone **U7** mounting plate
uchwyt **U7** cone

 inox
E4970019

rack U7 mounting plate
colour: inox
material: stainless steel

uchwyt **U7** rack
kolor: inox
materiał: stal nierdzewna

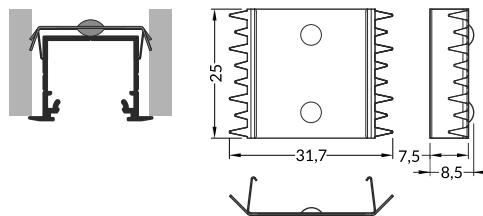

rack **U7** mounting plate
uchwyt **U7** rack

 inox
E4980019

spring U7 mounting plate
colour: inox
material: stainless steel

uchwyt **U7** sprężyna
kolor: inox
materiał: stal nierdzewna

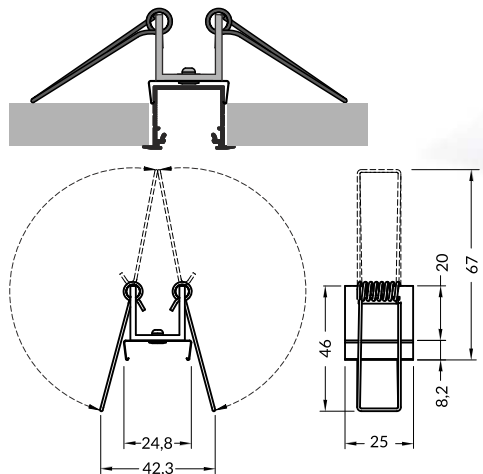

INDEX = 2 pcs
INDEKS = 2 szt.

spring **U7** mounting plate
uchwyt **U7** sprężyna

 inox
E4880019s

CLAMP / DOCISK

LINEA20 LED clamp
colour: white
material: painted steel, plastic

docisk LED LINEA20
kolor: biały
materiał: stal malowana,
tworzywo

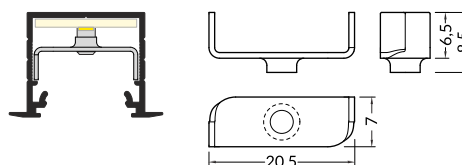



INDEX = 1 set
package of 10 sets = 20 pcs
INDEKS = 1 komplet, opakowanie
zawiera 10 kompletów = 20 szt.

 white
biały
C6940001

LINEA20-1 LED clamp
colour: white
material: painted steel, plastic

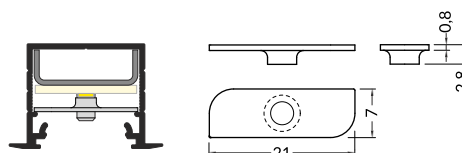
docisk LED LINEA20-1
kolor: biały
materiał: stal malowana,
tworzywo



 white
biały
C6930001

LINEA-IN20 EF/U7

CONNECTION POSSIBILITY MOŻLIWOŚCI ŁĄCZENIA



60°



90°



120°



135°



180°

ANGULAR CONNECTORS

Thanks to five different angle connectors (60° / 90° / 120° / 135° / 180°) it is possible to create many various lighting systems – with no need to cut the profile at an angle.

Bent connectors allows to connect profiles in two planes, at two angles: 90° on the inside and 270° on the outside.

ŁĄCZNIKI KĄTOWE

Dzięki łącznikom o pięciu różnych kątach (60° / 90° / 120° / 135° / 180°) możliwe jest tworzenie wielu różnych układów oświetlenia bez konieczności cięcia profilu pod skosem.

Łączniki gięte umożliwiają łączenie profili w dwóch płaszczyznach, pod dwoma kątami: wewnętrznym 90° i zewnętrznym 270°.

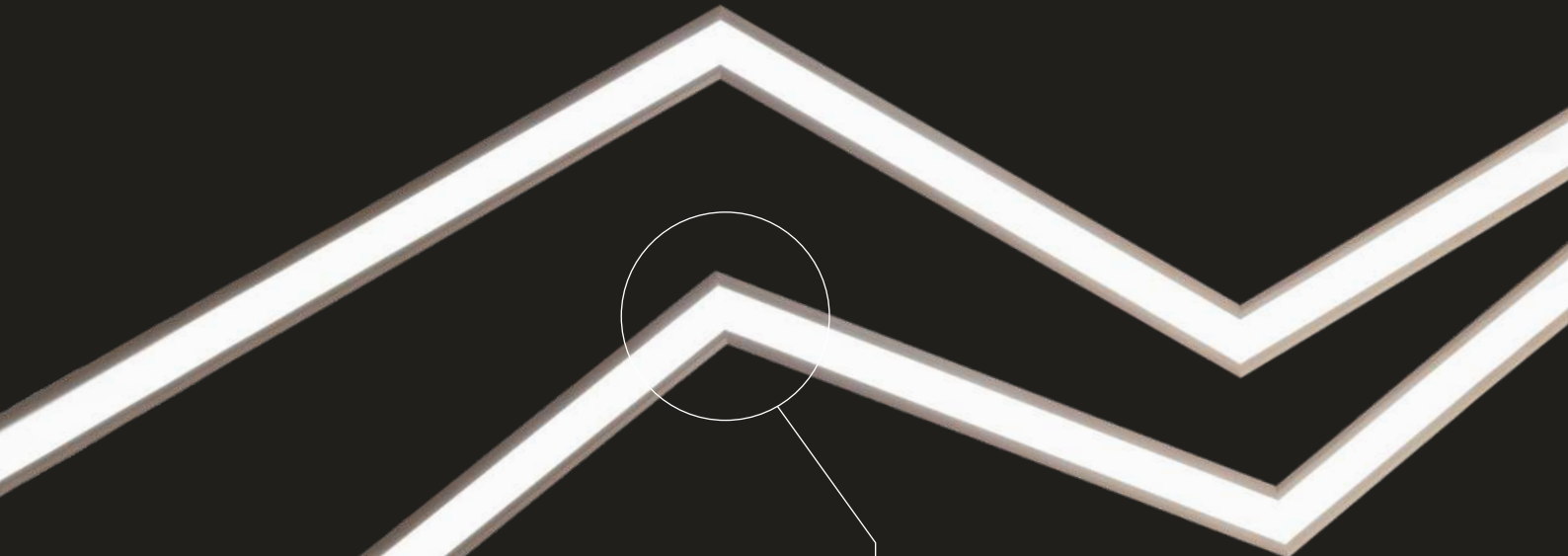

The component made of clear fabric provides secure connection, letting light through at the same time. Thanks to that, the luminaire can illuminate on the entire surface of the cover – even in the corners.

Element z przezroczystego tworzywa zapewnia stabilizację łączenia, jednocześnie przepuszczając światło. Dzięki temu oprawa może świecić na całej powierzchni klosza - również w rogach.



CONNECTORS / ŁĄCZNIKI

LINEA-IN20 connector 60 deg
colours: white, anodized, black
material: aluminium, polycarbonate

łącznik LINEA-IN20 60 st
kolory: biały, anodowany, czarny
materiał: aluminium, poliwęglan

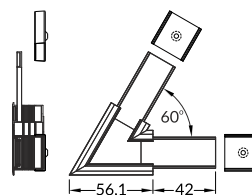

INDEX = 1 set
INDEKS = 1 zestaw

connector 60 deg
łącznik 60 st

-  white biały E4890001s
-  anodized anodowany E4890020s
-  black czarny E4890021s

LINEA-IN20 connector 90 deg
colours: white, anodized, black
material: aluminium, polycarbonate

łącznik LINEA-IN20 90 st
kolory: biały, anodowany, czarny
materiał: aluminium, poliwęglan

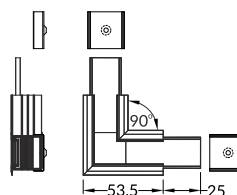

connector 90 deg
łącznik 90 st

-  white biały E4900001s
-  anodized anodowany E4900020s
-  black czarny E4900021s

LINEA-IN20 connector 90 deg bent
colours: white, anodized, black
material: aluminium, polycarbonate

łącznik LINEA-IN20 90 st gięty
kolory: biały, anodowany, czarny
materiał: aluminium, poliwęglan

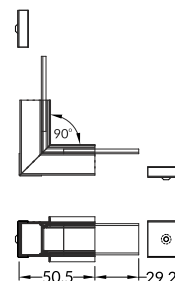

connector 90 deg bent
łącznik 90 st gięty

-  white biały E4910001s
-  anodized anodowany E4910020s
-  black czarny E4910021s

LINEA-IN20 connector 120 deg
colours: white, anodized, black
material: aluminium, polycarbonate

łącznik LINEA-IN20 120 st
kolory: biały, anodowany, czarny
materiał: aluminium, poliwęglan

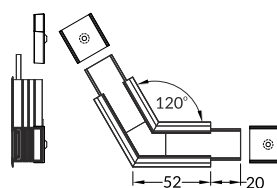

connector 120 deg
łącznik 120 st

-  white biały E4920001s
-  anodized anodowany E4920020s
-  black czarny E4920021s

LINEA-IN20 connector 135 deg
colours: white, anodized, black
material: aluminium, polycarbonate

łącznik LINEA-IN20 135 st
kolory: biały, anodowany, czarny
materiał: aluminium, poliwęglan

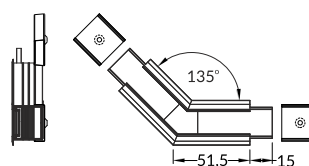

connector 135 deg
łącznik 135 st

-  white biały E4930001s
-  anodized anodowany E4930020s
-  black czarny E4930021s

LINEA-IN20 connector 180 deg
material: polycarbonate

łącznik LINEA-IN20 180 st
materiał: poliwęglan

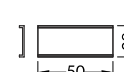

connector 180 deg
łącznik 180 st

E4940000s

LINEA-IN20 connector 270 deg bent
colours: white, anodized, black
material: aluminium, polycarbonate

łącznik LINEA-IN20 270 st gięty
kolory: biały, anodowany, czarny
materiał: aluminium, poliwęglan

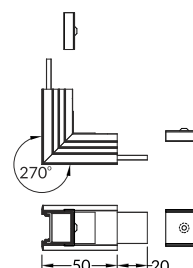

connector 270 deg bent
łącznik 270 st gięty

-  white biały E4950001s
-  anodized anodowany E4950020s
-  black czarny E4950021s

LINEA-IN20 EF/U7

CONTINUOUS LIGHT OF LINE
when using LED strip 120 P/m and white cover

CIĄGŁA LINIA ŚWIATŁA
przy użyciu taśm 120 P/m oraz klosza mlecznego







**CORNER
KATOWE**

2018

**LED profiles
profile LED**

TRIO10 BC

ANGULAR PROFILE 45°

PROFIL KĄTOWY 45°

- decorative and lighting profile
- for display cases' corners (mounted with screws)
- recessed (mounted with adhesive glue)
- suitable also for lighting up steps
- maximum LED strip width: 10 mm
- profil dekoracyjno-oświetleniowy
- do narożników gablot (montaż na wkręty)
- do wpuszczania (mocowanie na klej montażowy)
- nadaje się również do podświetlania stopni schodowych
- maksymalna szerokość taśmy LED: 10 mm

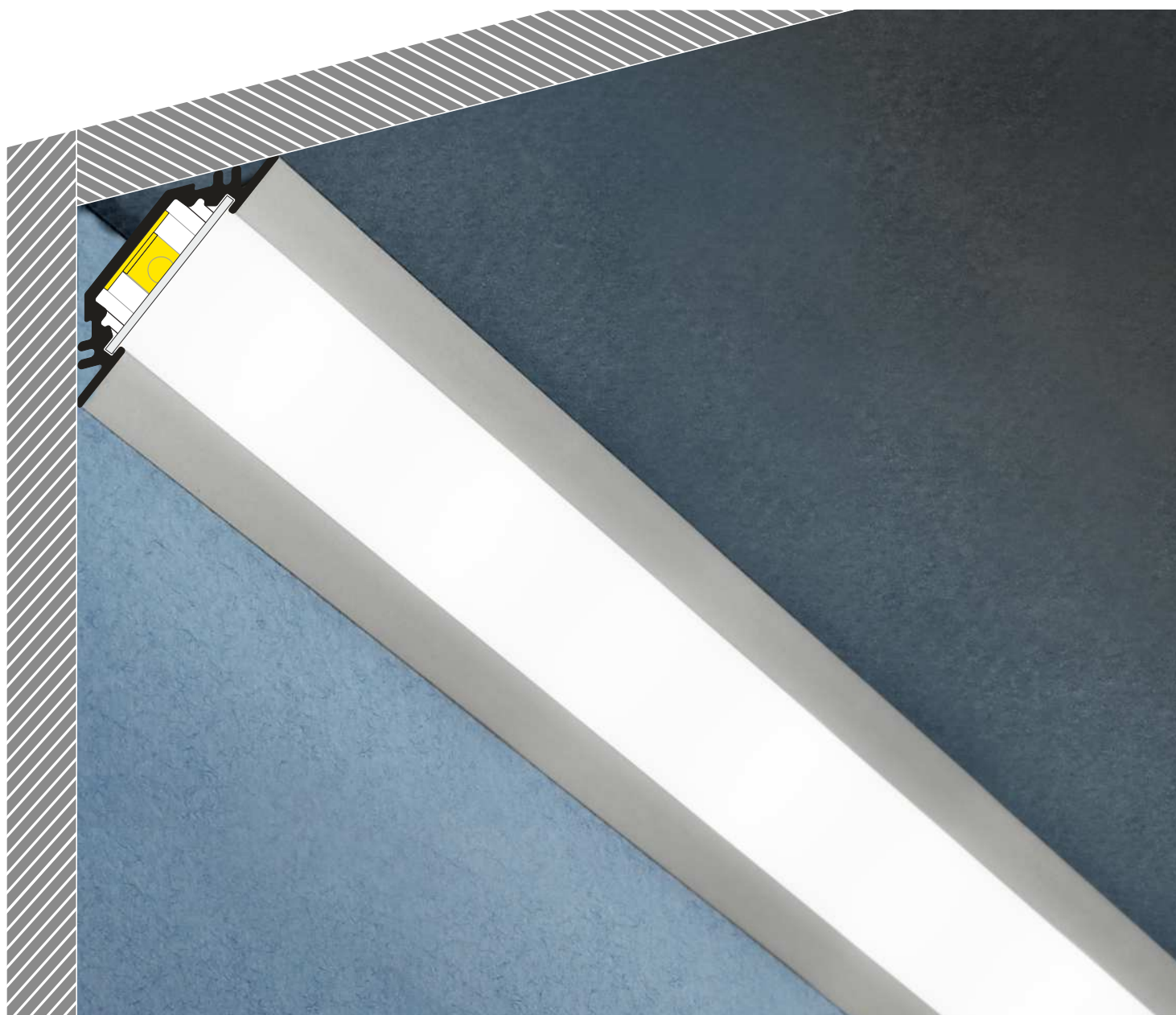

SIMILAR IN THE OFFER / PODOBNE W OFERCIE





B B slide cover
klosz B wsuwany

C C click cover
klosz C klik

C C lens cover
klosz C soczewka

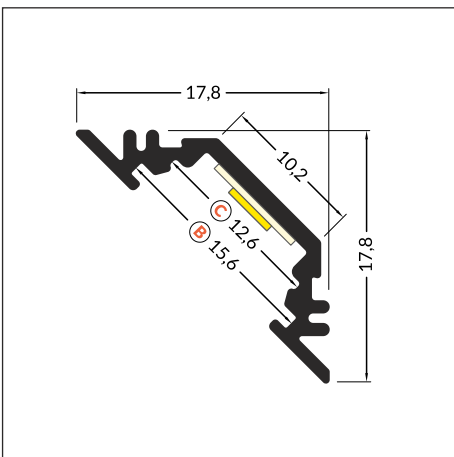
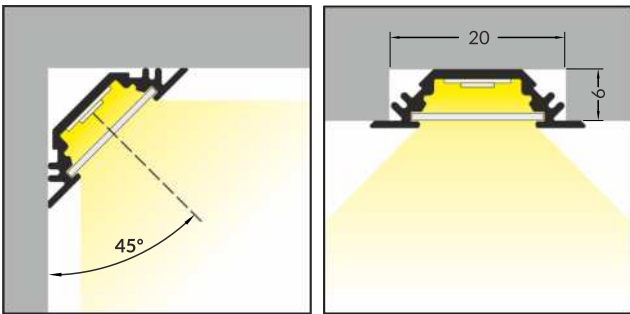
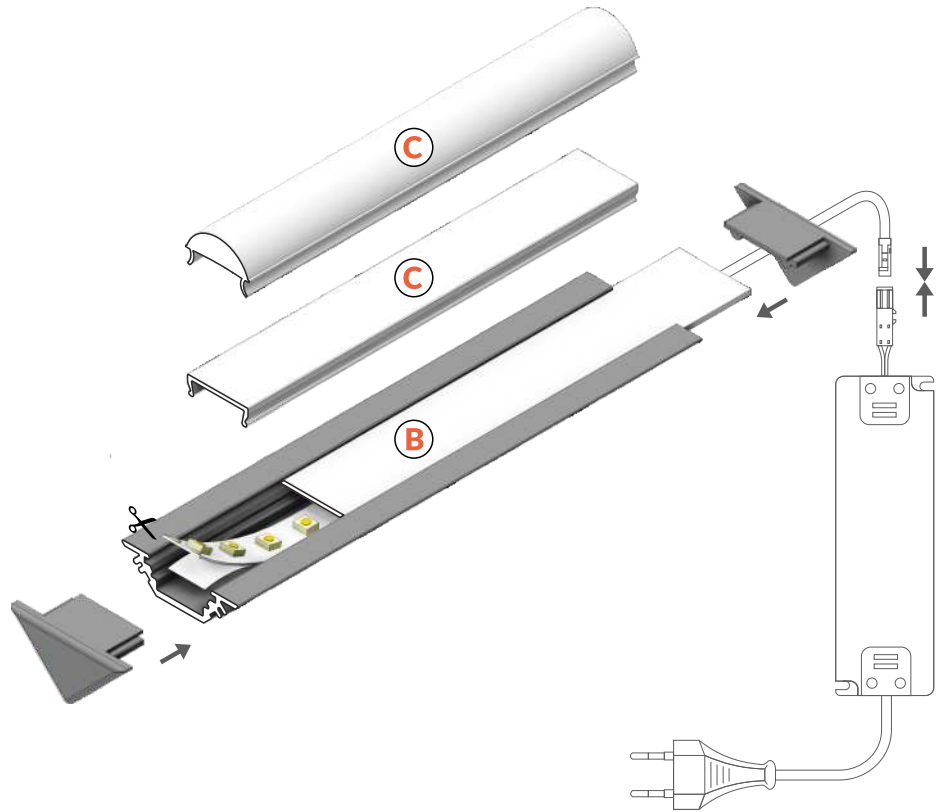

 max 10 mm

 corner
kątowy



INDEX = 1 pc, length 2000 mm
package = 10 pcs
INDEKS = 1 szt., długość 2000 mm
opakowanie = 10 szt.

 white painted
biały malowany
91030001

 anodized
anodowany
91030020

 black anodized
czarny anodowany
91030021

 raw aluminium
surowe aluminium
91030000



Available lengths / Dostępne długości
1000 mm, 2000 mm, 3000 mm, 4000 mm



COVERS / KLOSZE

B slide cover
colours: transparent, frosted, white
material: PC, PP, PP

klosz B wsuwany
kolory: transparentny, szron, mleczny
materiał: PC, PP, PP



Note! Dimensions of the space to install LED source
Uwaga! Wymiary przestrzeni do zamontowania źródła LED

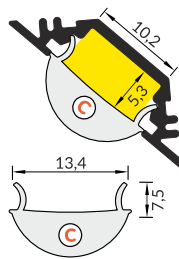
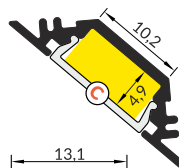
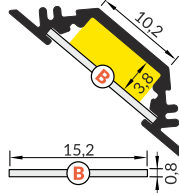

C click cover
colours: transparent, white
material: PMMA

klosz C klik
kolory: transparentny, mleczny
materiał: PMMA

C lens click cover
colour: transparent
material: PC

klosz C klik soczewka
kolor: transparentny
materiał: PC

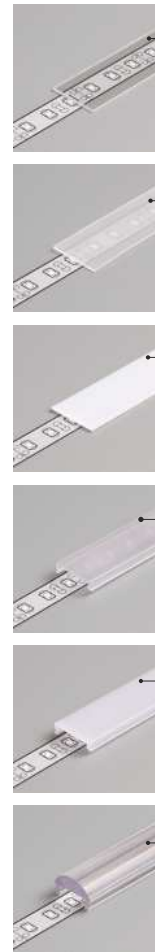

INDEX = 1 pc, length 2000 mm
package = 10 pcs
INDEKS = 1 szt., długość 2000 mm
opakowanie = 10 szt.

B transparent / B transparentny
76250016

B frosted / B szron
76250039

B white / B mleczny
76250038

C transparent / C transparentny
76330000

C white / C mleczny
76330038

C lens / C soczewka
76300000

ENDINGS / ZAŚLEPKI

TRIO10 ending
colours: white, silver, black, grey
material: ABS

zaślepka TRIO10
kolory: biały, srebrny, czarny, szary
materiał: ABS

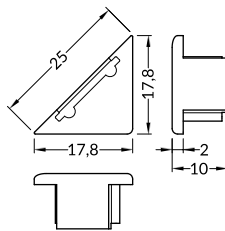

Ending with marked space to bore the holes.
Zaślepka z punktami do przewiercenia otworów.

INDEX = 1 set,
package of 10 sets = 20 pcs
INDEKS = 1 komplet, opakowanie
zawiera 10 kompletów = 20 szt.

white
białe 91060001

silver
srebrne 91060040

black
czarne 91060002

grey
szare 91060022

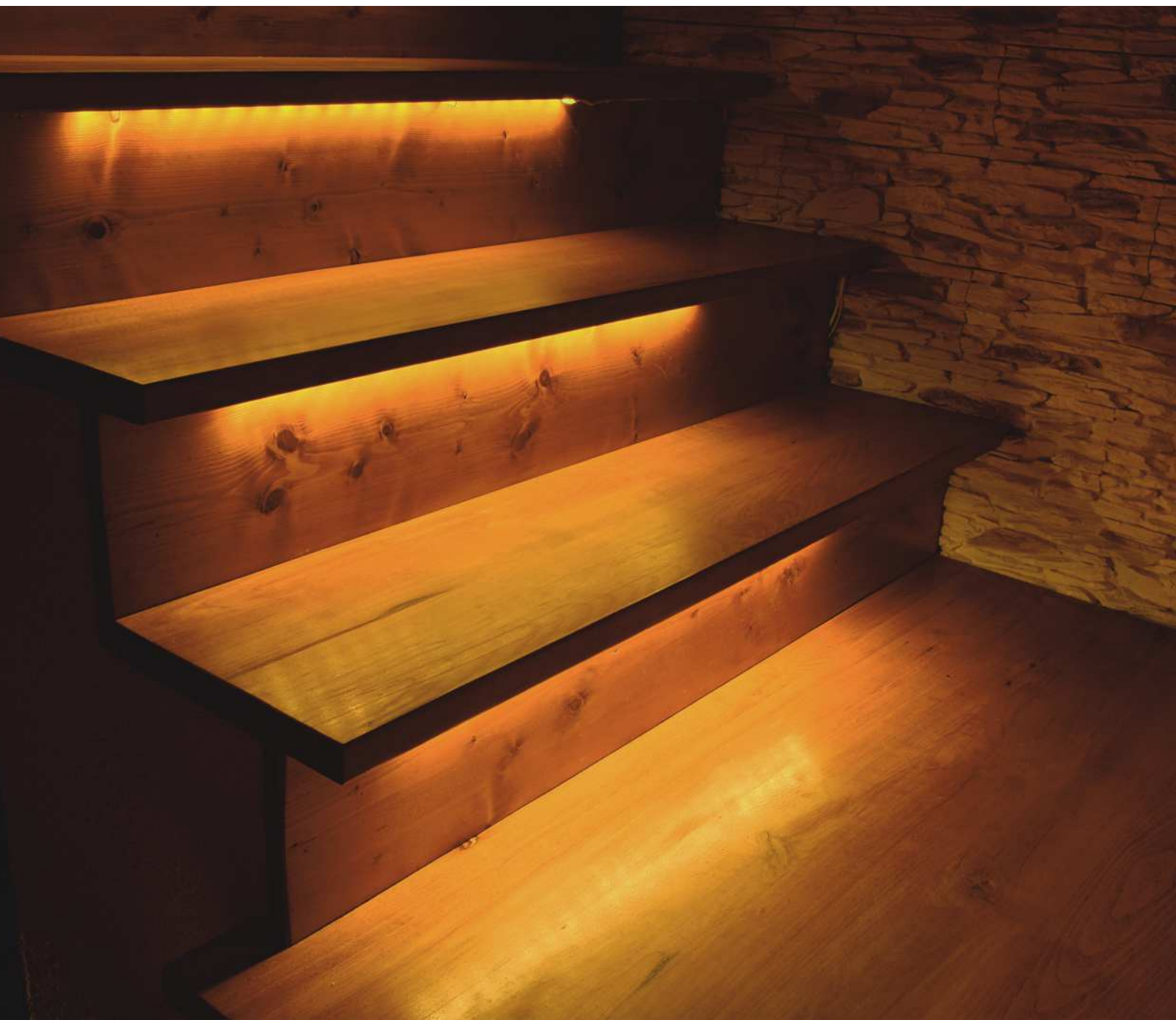

CORNER10 BC/UX

SMALL, ALUMINIUM, ANGULAR PROFILE

MAŁY, ALUMINIOWY PROFIL KĄTOWY

- lighting directions: 30° or 60°
- hidden mounting
- decorative and lighting profile
- wide range of accessories, 6 types of covers
- maximum LED strip width: 10 mm

- dwa kąty świecenia: 30° i 60°
- ukryte mocowanie
- profil dekoracyjno-oświetleniowy
- szeroki wybór akcesoriów, 6 rodzajów kloszy
- maksymalna szerokość taśmy LED: 10 mm



SIMILAR IN THE OFFER / PODOBNE W OFERCIE



TRIO10
BC



QUARTER10
BD/U6



CABI12
E



CORNER14
EF/TY



CORNER27
G/UX



- B** slide cover
klosz B wsuwany
- C** click cover
klosz C klik
- C** lens cover
klosz C soczewka
- U**¹ flexible mounting plate
uchwyt U sprężysty
- U**² cone U flexible mounting plate
uchwyt U sprężysty cone
- X**¹ X mounting plate
uchwyt X

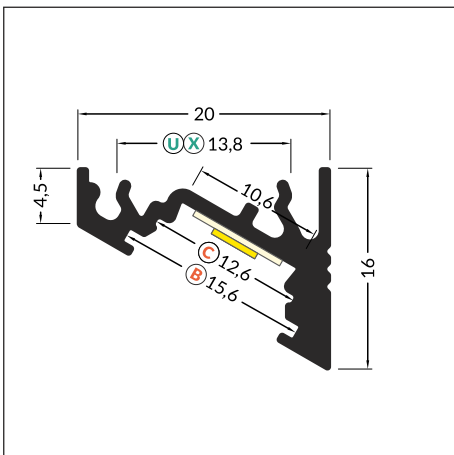
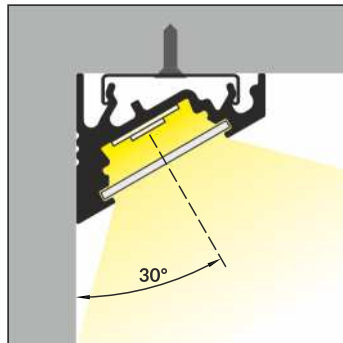
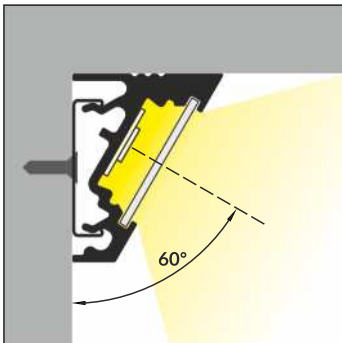
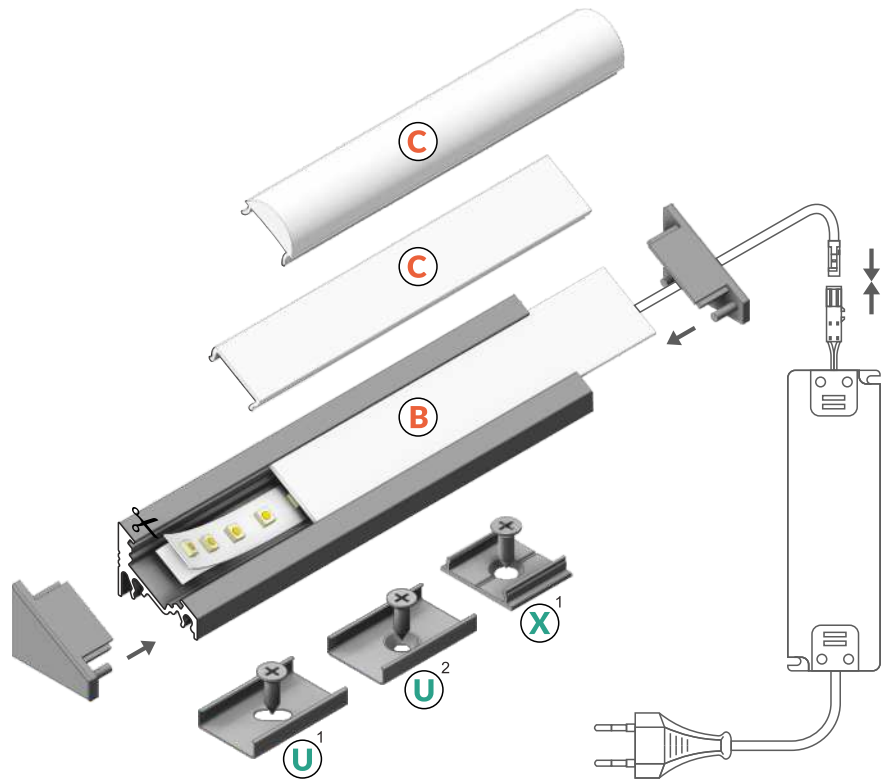

INDEX = 1 pc, length 2000 mm
package = 10 pcs
INDEKS = 1 szt., długość 2000 mm
opakowanie = 10 szt.

 white painted
biały malowany
83050001

 anodized
anodowany
83050020

 black anodized
czarny anodowany
83050021

 raw aluminium
surowe aluminium
83050000

Available lengths / Dostępne długości
1000 mm, 2000 mm, 3000 mm, 4000 mm



COVERS / KLOSZE



B slide cover

colours: transparent, frosted, white
material: PC, PP, PP

klosz B wsuwany
kolory: transparentny, szron, mleczny
materiał: PC, PP, PP

Note! Dimensions of the space to install LED source
Uwaga! Wymiary przestrzeni do zamontowania źródła LED

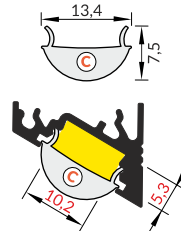
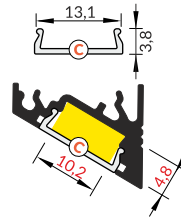
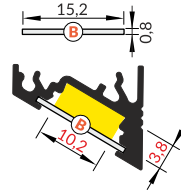

C click cover

colours: transparent, white
material: PMMA

klosz C klik
kolory: transparentny, mleczny
materiał: PMMA

C click cover lens

colour: transparent
material: PC

klosz C klik soczewka
kolor: transparentny
materiał: PC

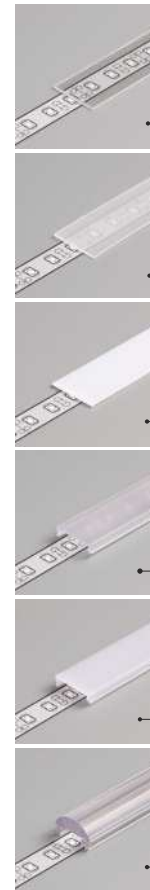

INDEX = 1 pc, length 2000 mm
package = 10 pcs
INDEKS = 1 szt., długość 2000 mm
opakowanie = 10 szt.

B transparent / B transparentny
76250016

B frosted / B szron
76250039

B white / B mleczny
76250038

C transparent / C transparentny
76330000

C white / C mleczny
76330038

C lens / C soczewka
76300000

ENDINGS / ZAŚLEPKI

endings CORNER10

colours: white, silver, black, grey
material: ABS

zaślepka CORNER10
kolory: biały, srebrny, czarny, szary
materiał: ABS

endings CORNER10 with hole

colours: white, silver, black, grey
material: ABS

zaślepka CORNER10 z otworem
kolory: biały, srebrny, czarny, szary
materiał: ABS

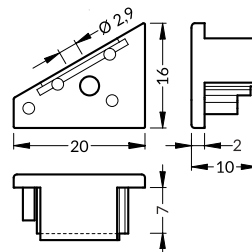

INDEX = 1 set
package of 10 sets = 20 pcs
INDEKS = 1 komplet, opakowanie zawiera 10 kompletów = 20 szt.

| | | | |
|--|----------------|------------------------------------|--|
| | white białe | with hole z otworem 83130001 | without hole bez otworu 83150001 |
|--|----------------|------------------------------------|--|

| | | | |
|--|-------------------|------------------------------------|--|
| | silver srebrne | with hole z otworem 83130040 | without hole bez otworu 83150040 |
|--|-------------------|------------------------------------|--|

| | | | |
|--|-----------------|------------------------------------|--|
| | black czarne | with hole z otworem 83130002 | without hole bez otworu 83150002 |
|--|-----------------|------------------------------------|--|

| | | | |
|--|---------------|------------------------------------|--|
| | grey szare | with hole z otworem 83130022 | without hole bez otworu 83150022 |
|--|---------------|------------------------------------|--|

CONNECTORS / ŁĄCZNIKI

X connector 180 deg

colour: raw aluminium
material: aluminium

łącznik X 180 st
kolor: surowe aluminium
materiał: aluminium

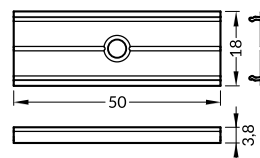

INDEX = 1 set
INDEKS = 1 komplet

X connector łącznik X

| | |
|--|---|
| | raw aluminium surowe aluminium 76350000 |
|--|---|

CORNER10 connector 90 deg

colours: white, anodized, black
material: aluminium

łącznik CORNER10 90 st
kolory: biały, anodowany, czarny
materiał: aluminium

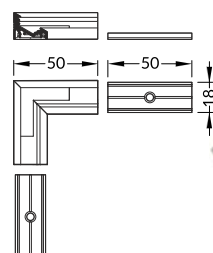

L connector / łącznik L

| | | |
|--|---------------------------------|----------|
| | white painted biały malowany | 83110001 |
|--|---------------------------------|----------|

| | | |
|--|-----------------------|----------|
| | anodized anodowany | 83110020 |
|--|-----------------------|----------|

| | | |
|--|------------------------------------|----------|
| | black anodized czarny anodowany | 83110021 |
|--|------------------------------------|----------|



MOUNTINGS / MOCOWANIA

U flexible mounting plate

colours: inox
material: stainless steel

uchwyt U sprężysty
kolory: inox
materiał: stal nierdzewna

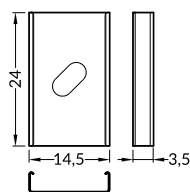
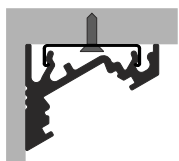

INDEX = 1 set
package of 10 sets = 20 pcs
INDEKS = 1 komplet
opakowanie zawiera 10 kpl = 20 szt

U flexible mounting plate
uchwyt U sprężysty

● inox 76380000

cone U flexible mounting plate

colours: inox
material: stainless steel

uchwyt U sprężysty cone
kolory: inox
materiał: stal nierdzewna

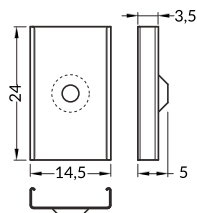
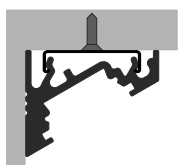

cone U flexible mounting plate
uchwyt U sprężysty cone

● inox 76620000

X mounting plate

colours: raw aluminium
material: aluminium

uchwyt X
kolory: surowe aluminium
materiał: aluminium

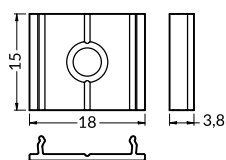
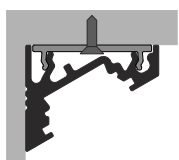

X mounting plate
uchwyt X

● raw aluminium
surowe aluminium
76260000

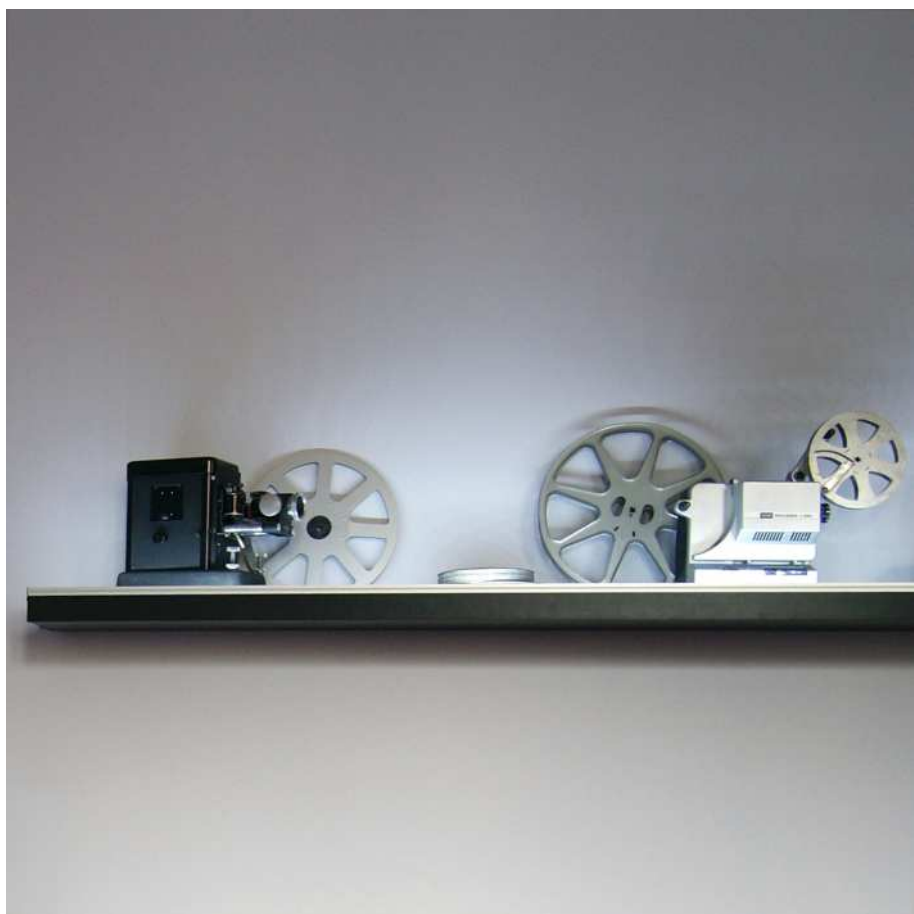

QUARTER10 BD/U6

LIGHT FROM AN ANGLE

ŚWIATŁO Z NAROŻNIKA

- full circle quadrant illumination
- LED strip aligned to 45° angle
- Slick socket
- maximum LED strip width: 10 mm
- pełne oświetlenie ćwiartki koła
- taśma ustawiona pod kątem 45 stopni
- gniazdo Slick
- maksymalna szerokość taśmy LED: 10 mm

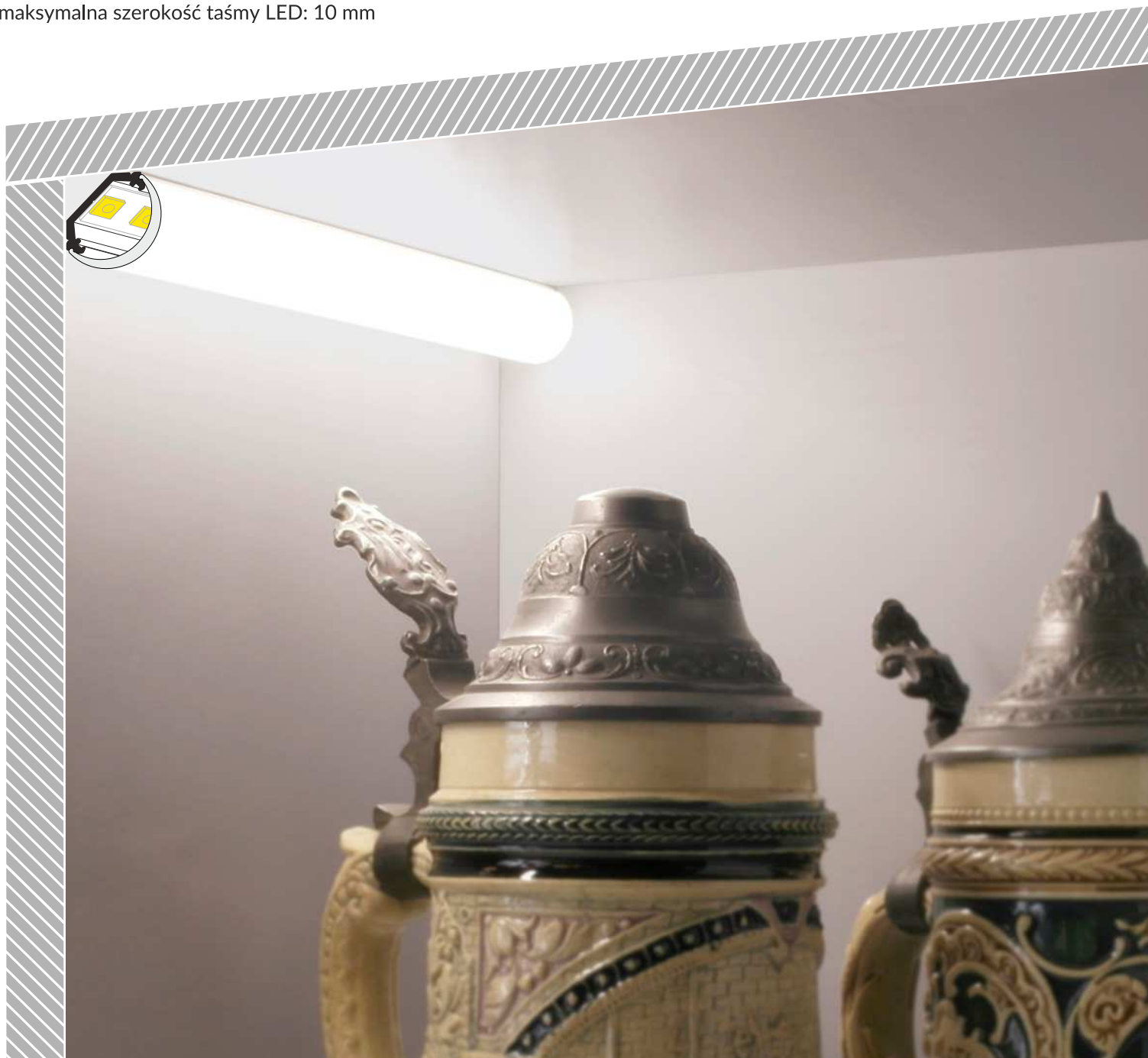

SIMILAR IN THE OFFER / PODOBNE W OFERCIE



TRIO10
BC



CORNER10
BC/UX



CABI12
E



CORNER14
EF/TY



CORNER27
G/UX



B slide cover
klosz B wsuwany

D click cover
klosz D klik

U6¹ U6 mounting plate
uchwyt U6

U6² cone U6 mounting plate
uchwyt U6 cone

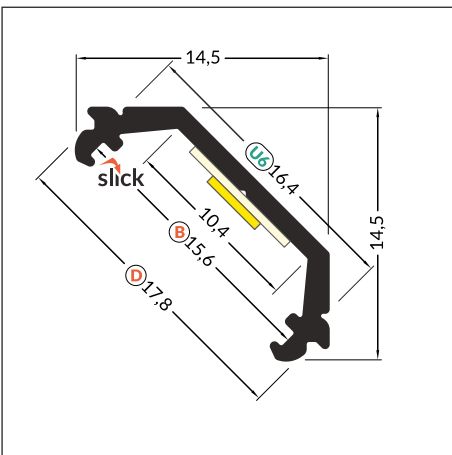
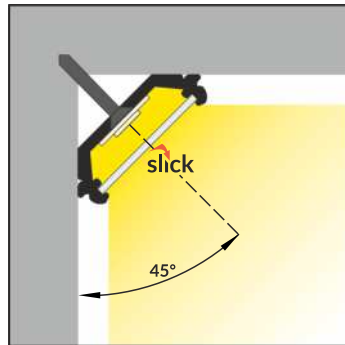
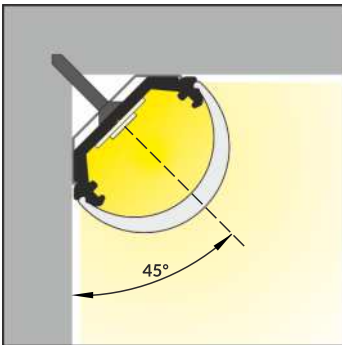
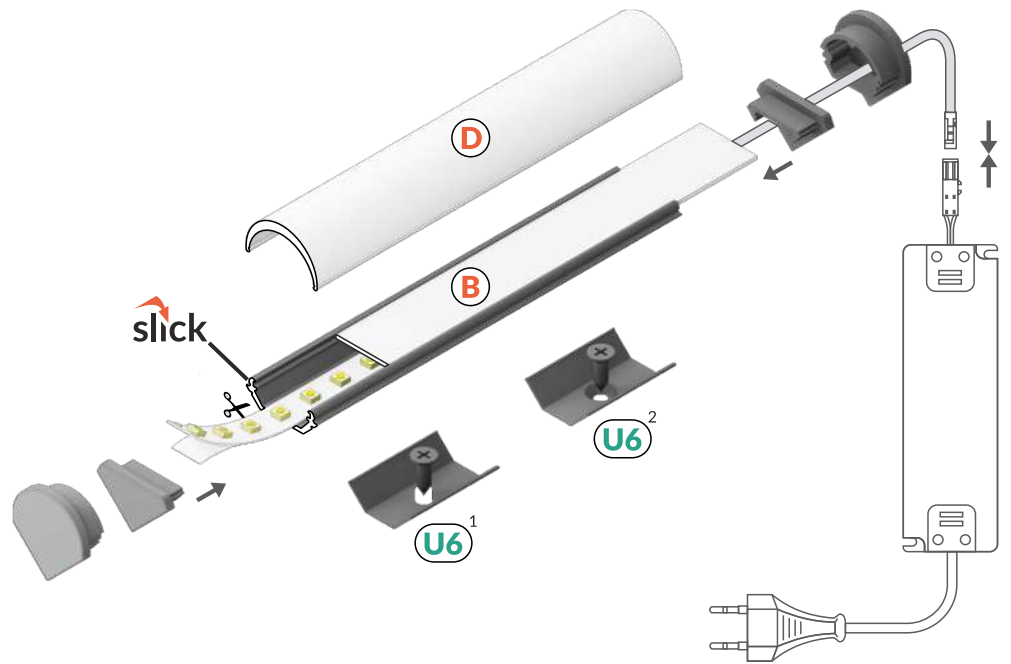

 max 10 mm

 corner
kątowy

INDEX = 1 pc, length 2000 mm
package = 10 pcs
INDEKS = 1 szt., długość 2000 mm
opakowanie = 10 szt.

 anodized
anodowany
D3020020

Available lengths / Dostępne długości
1000 mm, 2000 mm, 3000 mm, 4000 mm



COVERS / KLOSZE

B slide cover

colours: transparent, frosted, white
material: PC, PP, PP

klosz B wsuwany
kolory: transparentny, szron, mleczny
materiał: PC, PP, PP

D click cover

colour: white
material: PMMA

klosz D klik
kolor: mleczny
materiał: PMMA



Note! Dimensions of the space to install LED source
Uwaga! Wymiary przestrzeni do zamontowania źródła LED

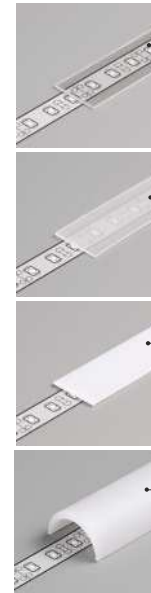
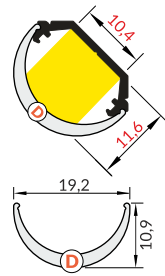
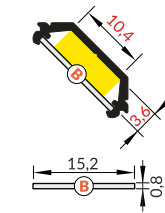

INDEX = 1 pc, length 2000 mm
package = 10 pcs
INDEKS = 1 szt., długość 2000 mm
opakowanie = 10 szt.

B transparent / B transparentny
76250016

B frosted / B szron
76250039

B white / B mleczny
76250038

D white / D mleczny
A1140038

ENDINGS / ZAŚLEPKI

QUARTER10 ending

colours: silver, grey
material: ABS
zaślepka QUARTER10
kolory: srebrno, szary
materiał: ABS



Ending with marked space to bore the holes.
Zaślepka z punktami do przewiercenia otworów.

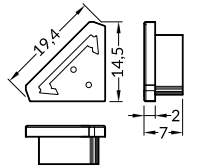

QUARTER10 D ending

colours: silver, grey
material: ABS
zaślepka QUARTER10 D
kolory: srebrno, szary
materiał: ABS

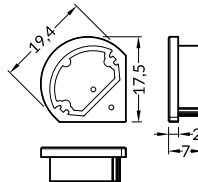

INDEX = 1 set
package of 10 sets = 20 pcs
INDEKS = 1 komplet
opakowanie zawiera 10 kpl = 20 szt

silver
srebrne D3980040

grey
szary D3980022

silver
srebrne D3990040

grey
szary D3990022

MOUNTINGS / MOCOWANIA

U6 mounting plate

colours: inox
material: stainless steel

uchwyt U6
kolory: inox
materiał: stal nierdzewna

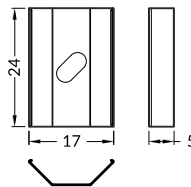
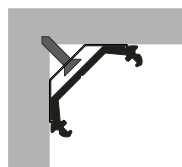

INDEX = 1 set
package of 10 sets = 20 pcs
INDEKS = 1 komplet
opakowanie zawiera 10 kpl = 20 szt

U6 mounting plate
uchwyt U6

inox
inox D3960019

cone U6 mounting plate

colours: inox
material: stainless steel

uchwyt U6 cone
kolory: inox
materiał: stal nierdzewna

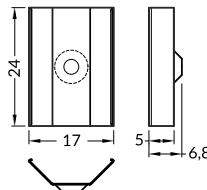
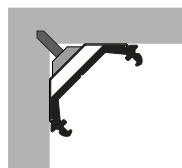

cone U6 mounting plate
uchwyt U6 cone

inox
inox D3970019



A PROFILE FOR SHOW CASE'S INSIDE VERTICAL AND HORIZONTAL ILLUMINATION

PROFIL DO OŚWIETLENIA WNĘTRZA GABLOTY W PIONIE I POZIOMIE

- decorative and lighting profile
- two lighting angles: 30°/60°
- small sizes, no holders and a channel for hiding cables - minimum interference in glass show case's look
- Slick socket
- maximum LED strip width: 12 mm
- profil dekoracyjno-oświetleniowy
- dwa kąty świecenia: 30°/60°
- niewielkie gabaryty, brak uchwytów oraz kanał do schowania przewodów - minimalna ingerencja w wygląd szklanej gabloty
- gniazdo z funkcją Slick
- taśmy LED: 12 mm

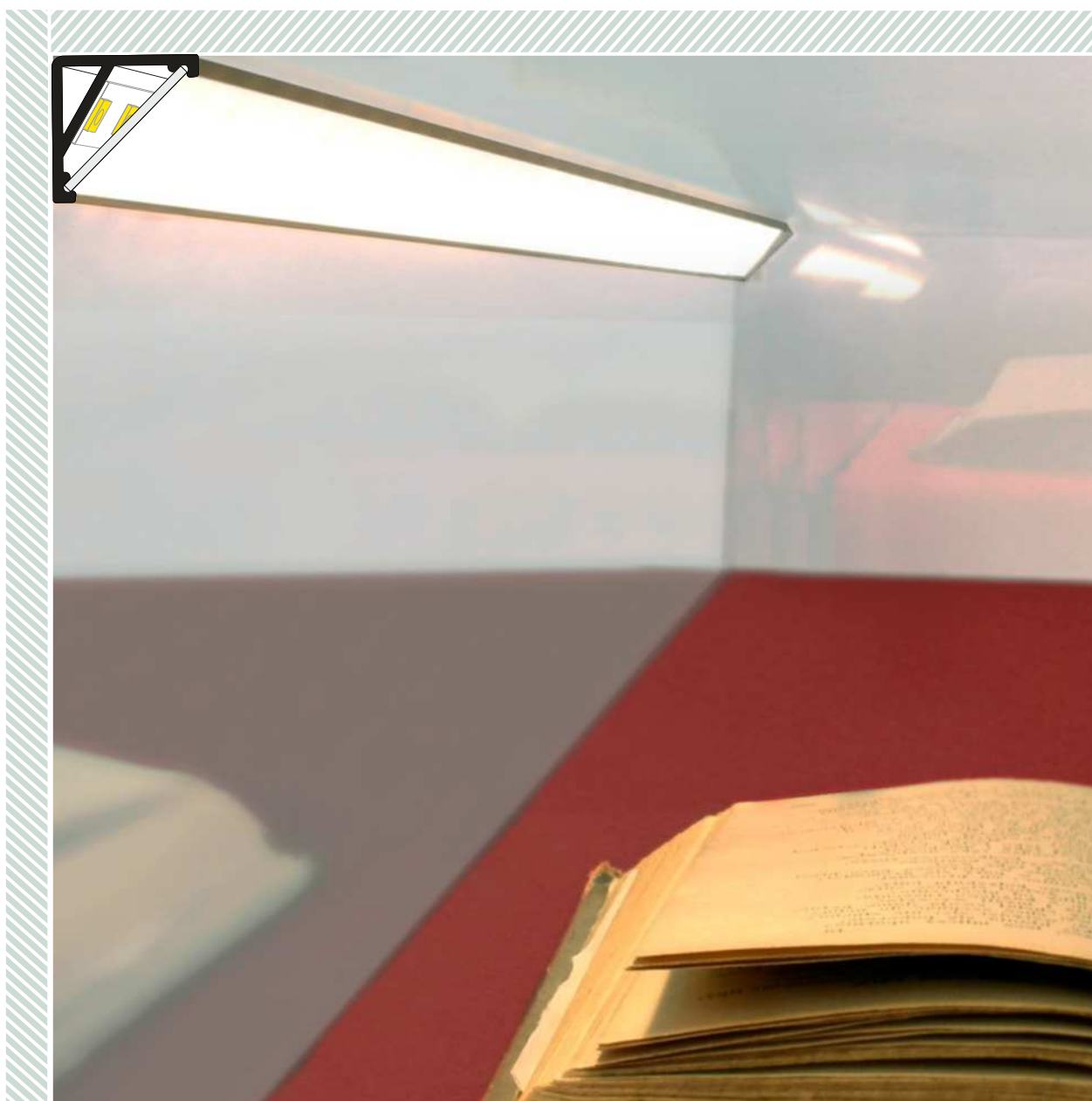

SIMILAR IN THE OFFER / PODOBNE W OFERCIE



TRIO10
BC



CORNER10
BC/UX



QUARTER10
BD/U6



CORNER14
EF/TY



CORNER27
G/UX



PEN8
I



E slide cover
klosz E wsuwany

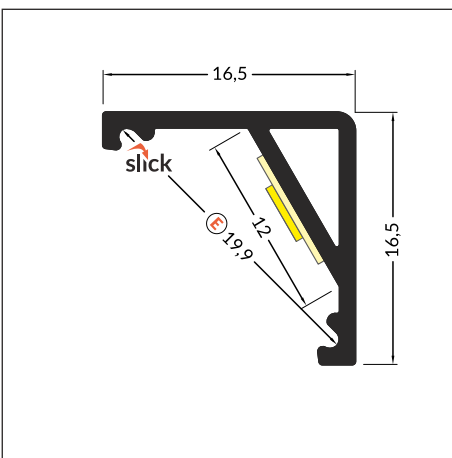
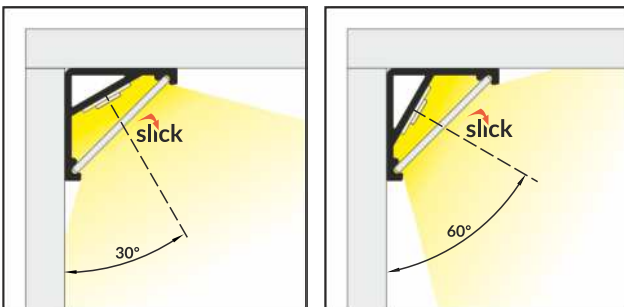
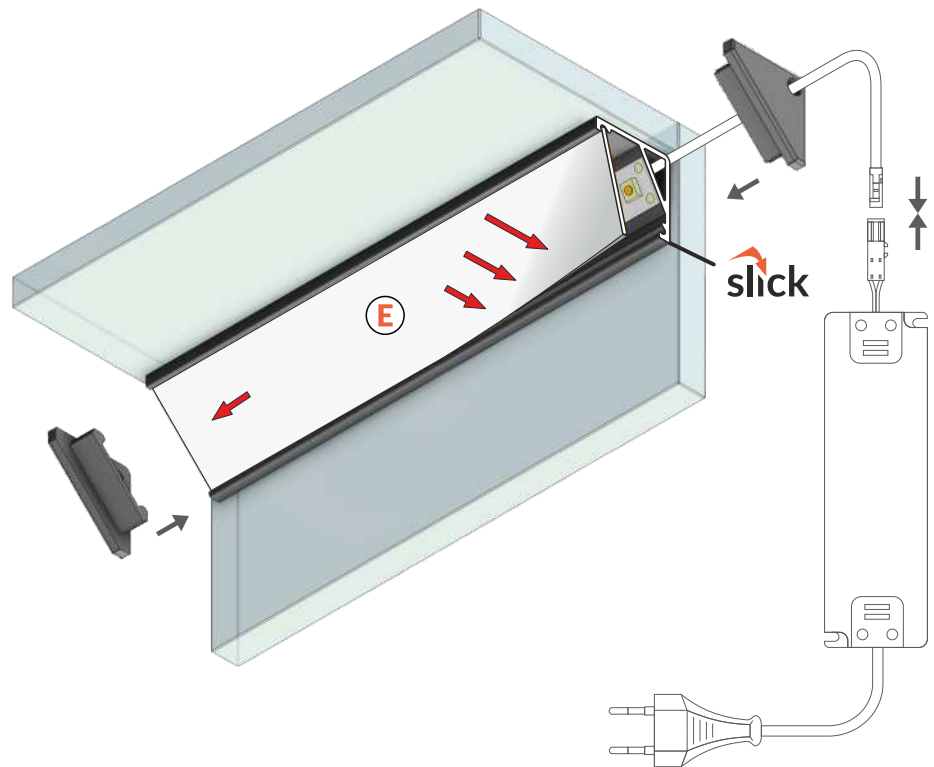

 max 12 mm

 corner
kątowy



INDEX = 1 pc, length 2000 mm
package = 10 pcs
INDEKS = 1 szt., długość 2000 mm
opakowanie = 10 szt.

 white painted
biały malowany
C9020001

 anodized
anodowany
C9020020

 black anodized
czarny anodowany
C9020021

 raw aluminium
surowe aluminium
C9020000

Available lengths / Dostępne długości
1000 mm, 2000 mm



COVERS / KLOSZE

E slide cover
colours: transparent, frosted, white
material: PC, PP, PP

klosz E wsuwany
kolory: transparentny, szron, mleczny
materiał: PC, PP, PP



Note! Dimensions of the space to install LED source
Uwaga! Wymiary przestrzeni do zamontowania źródła LED

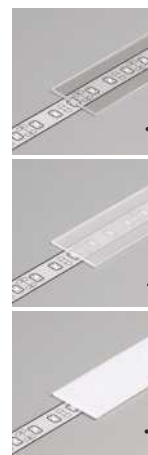
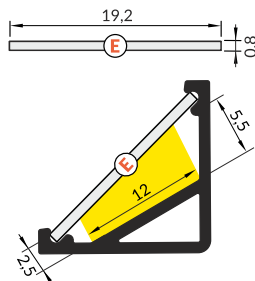

INDEX = 1 pc, length 2000 mm
package = 10 pcs
INDEKS = 1 szt., długość 2000 mm
opakowanie = 10 szt.

E transparent / E transparentny
A2040016

E frosted / E szron
A2040039

E white / E mleczny
A2040038

ENDINGS / ZAŚLEPKI

CABI12 ending
colours: white, silver, black, grey
material: ABS

zaślepka CABI12
kolory: biały, srebrny, czarny, szary
materiał: ABS

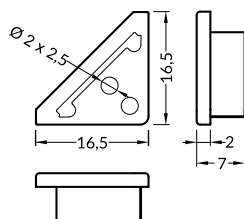

Ending with marked space to bore the holes.
Zaślepka z punktami do przewiercenia otworów.

INDEX = 1 set
package of 10 sets = 20 pcs
INDEKS = 1 komplet, opakowanie
zawiera 10 kompletów = 20 szt.

-  white
białe **C9980001**
-  silver
srebrne **C9980040**
-  black
czarne **C9980002**
-  grey
szare **C9980022**



INVISIBLE WIRES

Special channel to hide the wires allows to remain esthetic look of the showcase.

NIEWIDOCZNE PRZEWODY

Kanał do schowania przewodów pozwala zachować estetyczny wygląd gabloty.



EQUAL SIDE LENGTHS

The symmetrical profile design allows precise connections in a different configurations.

RÓWNE DŁUGOŚCI BOKÓW

Symetryczna budowa profilu umożliwia precyzyjne łączenie w różnych konfiguracjach.

CORNER14 EF/TY

ANGULAR PROFILE 30°/60°

PROFIL KĄTOWY 30°/60°

- decorative and lighting profile
- hidden mounting
- two lighting angles: 30°/60°
- maximum LED strip width: 14 mm
- profil dekoracyjno-oświetleniowy
- ukryte mocowanie
- dwa kąty świecenia: 30°/60°
- maksymalna szerokość taśmy LED: 14 mm

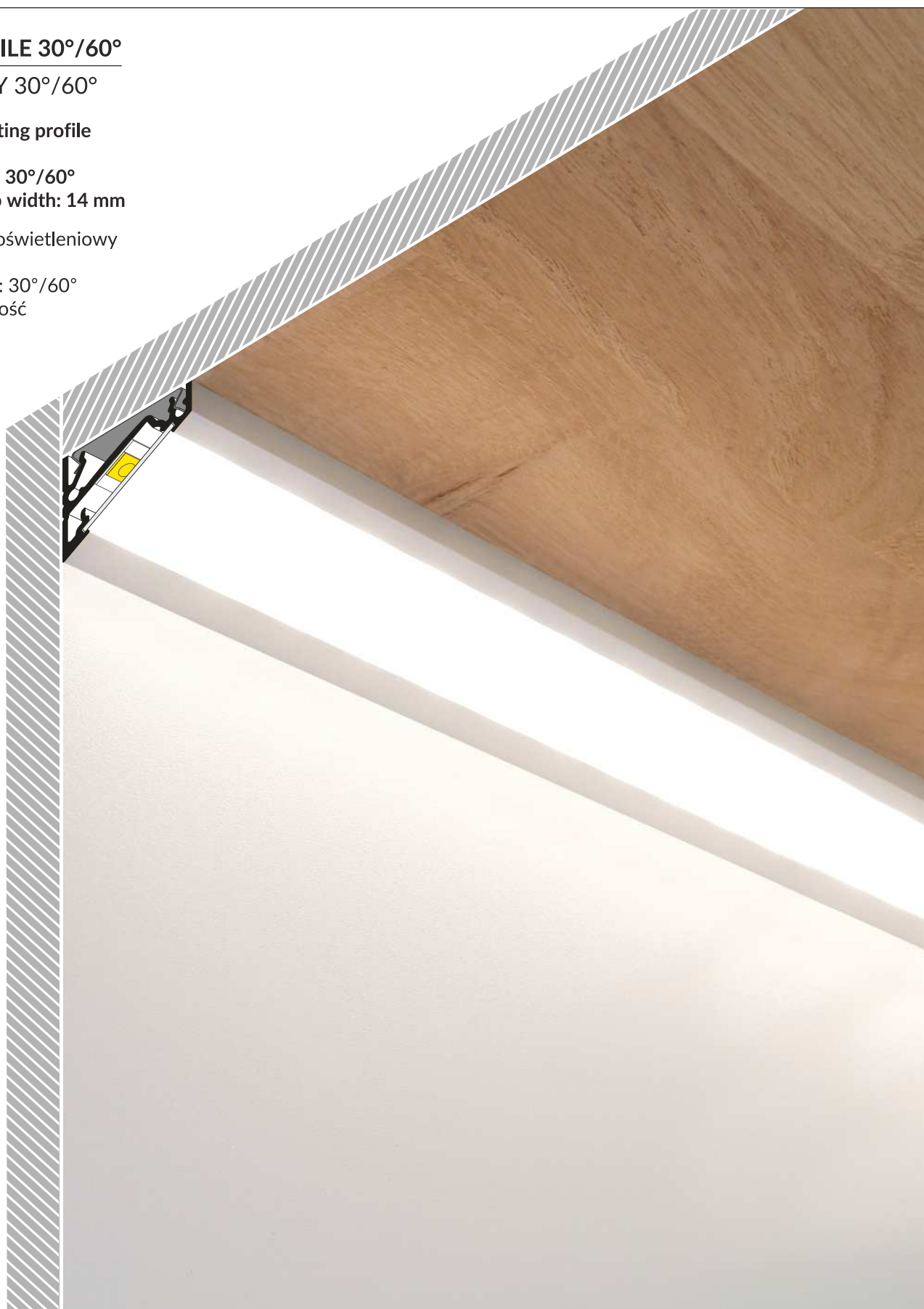

SIMILAR IN THE OFFER / PODOBNE W OFERCIE



TRIO10
BC



CORNER10
BC/UX



QUARTER10
BD/U6



CABI12
E



CORNER27
G/UX



E **E** slide cover
klosz **E** wsuwany

F **F** click cover
klosz **F** klik

E7 **E7** click cover
klosz **E7** klik

Y¹ **Y** flexible mounting plate
uchwyt **Y** sprężysty

Y² **cone Y** flexible mounting plate
uchwyt **Y** sprężysty cone

T **T** mounting plate
uchwyt **T**

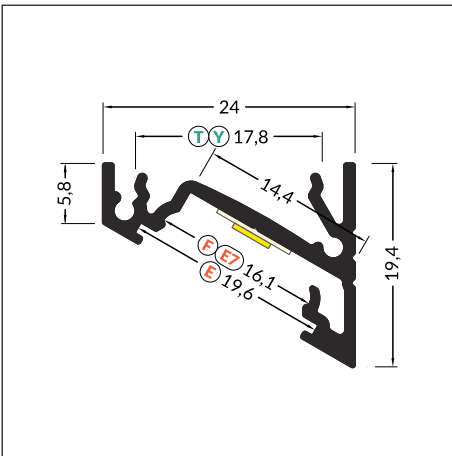
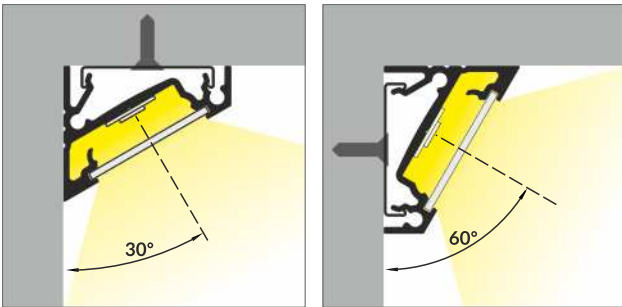
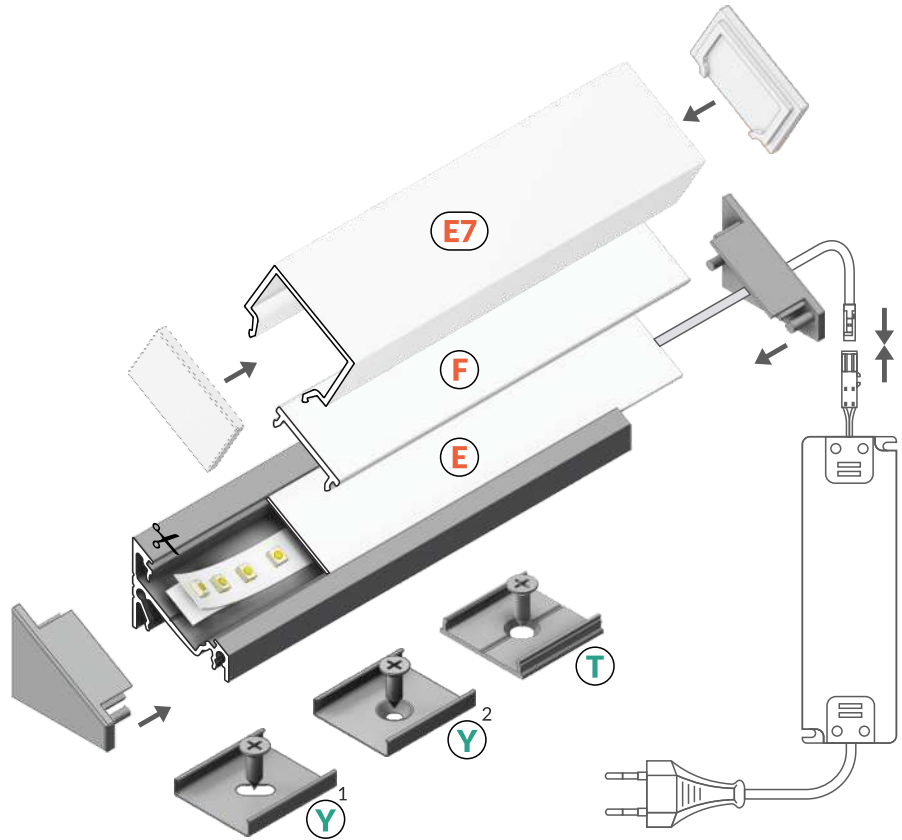

INDEX = 1 pc, length 2000 mm
package = 10 pcs
INDEKS = 1 szt., długość 2000 mm
opakowanie = 10 szt.

 white painted
biały malowany
A4020001

 anodized
anodowany
A4020020

 black anodized
czarny anodowany
A4020021

 raw aluminium
surowe aluminium
A4020000

 max 14 mm

 corner
kątowy

Available lengths / Dostępne długości
1000 mm, 2000 mm, 3000 mm, 4000 mm



COVERS / KLOSZE

E slide cover
colours: transparent, frosted, white
material: PC, PP, PP

klosz E wsuwany
kolory: transparentny, szron, mleczny
materiał: PC, PP, PP



Note! Dimensions of the space to install LED source
Uwaga! Wymiary przestrzeni do zamontowania źródła LED

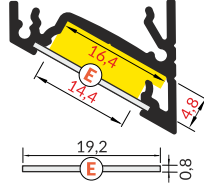

F click cover
colours: transparent, white
material: PMMA

klosz F klik
kolory: transparentny, mleczny
materiał: PMMA

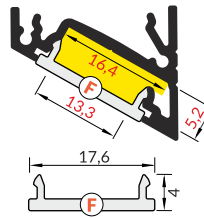

E7 click cover
colour: white
material: PMMA

klosz E7 klik
kolor: mleczny
materiał: PMMA

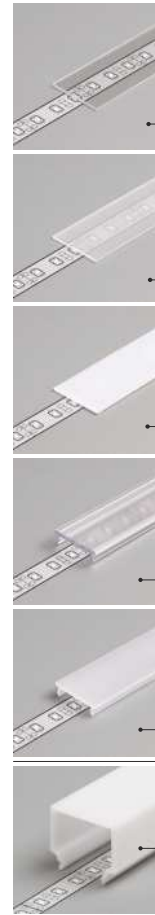
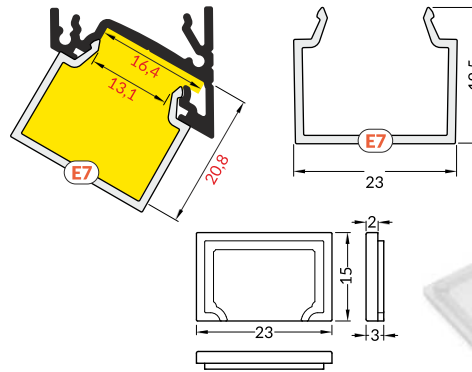

INDEX = 1 pc, length 2000 mm
package = 10 pcs
INDEKS = 1 szt., długość 2000 mm
opakowanie = 10 szt.

E transparent / E transparentny
A2040016

E frosted / E szron
A2040039

E white / E mleczny
A2040038

F transparent / F transparentny
A2060016

F white / F mleczny
A2060038

E7 white / E7 mleczny
C1080038

INDEX = 1 set
package of 10 sets = 20 pcs
INDEKS = 1 komplet, opakowanie
zawiera 10 kompletów = 20 szt.

E7 white ending
zaślepka E7 mleczny
C1840038

MOUNTING / MOCOWANIA

Y flexible mounting plate
colour: inox
material: stainless steel

uchwyt Y sprężysty
kolor: inox
materiał: stal nierdzewna

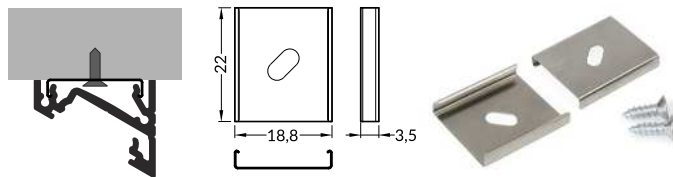

cone Y flexible mounting plate
colour: inox
material: stainless steel

uchwyt Y sprężysty cone
kolor: inox
materiał: stal nierdzewna

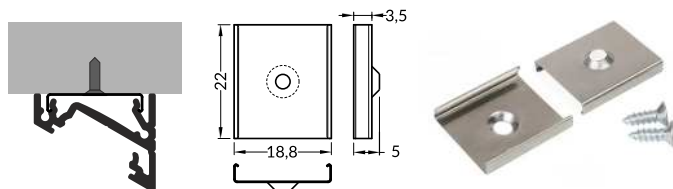

T mounting plate
colour: raw aluminium
material: aluminium

uchwyt T
kolor: surowe aluminium
materiał: aluminium

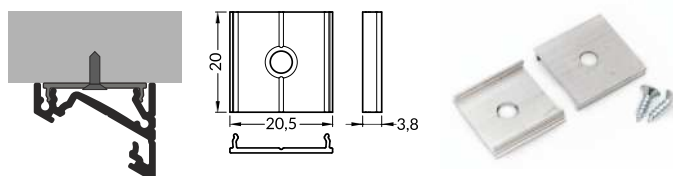

INDEX = 1 set
package of 10 sets = 20 pcs
INDEKS = 1 komplet, opakowanie
zawiera 10 kompletów = 20 szt.

Y flexible mounting plate
uchwyt Y sprężysty

inox
inox A2090019

cone Y flexible mounting plate
uchwyt Y sprężysty cone

inox
inox A2130019

T mounting plate
uchwyt T

raw aluminium
surowe aluminium
C6960000



ENDINGS / ZAŚLEPKI

CORNER14 ending

colours: white, silver, black, grey
material: ABS

zaślepka CORNER14

kolory: biały, srebrny, czarny, szary
material: ABS

CORNER14 ending with hole

colours: white, silver, black, grey
material: ABS

zaślepka CORNER14 z otworem

kolory: biały, srebrny, czarny, szary
material: ABS

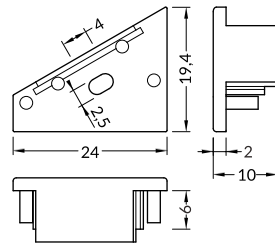

INDEX = 1 set
package of 10 sets = 20 pcs
INDEKS = 1 komplet, opakowanie
zawiera 10 kompletów = 20 szt.

○ white
białe

with hole
z otworem
A4050001

without hole
bez otworu
A4070001

● silver
srebrne

with hole
z otworem
A4050040

without hole
bez otworu
A4070040

● black
czarne

with hole
z otworem
A4050002

without hole
bez otworu
A4070002

● grey
szare

with hole
z otworem
A4050022

without hole
bez otworu
A4070022

CONNECTORS / ŁĄCZNIKI

T connector 180 deg

colour: raw aluminium
material: aluminium

łącznik T 180 st

kolor: surowe aluminium
material: aluminium

CORNER14 connector 90 deg

colours: white, anodized, black
material: aluminium

łącznik CORNER14 90 st

kolory: biały, anodowany, czarny
material: aluminium

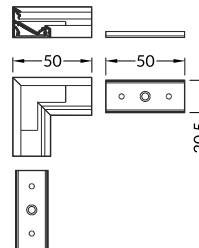
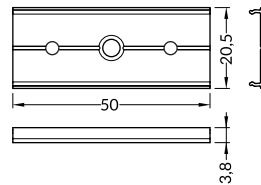

INDEX = 1 set
INDEKS = 1 komplet

T connector / łącznik T

● raw aluminium
surowe aluminium
C6990000

connector 90 deg / łącznik 90 st

○ white painted
biały malowany
A4990001

● anodized
anodowany
A4990020

● black anodized
czarny anodowany
A4990021

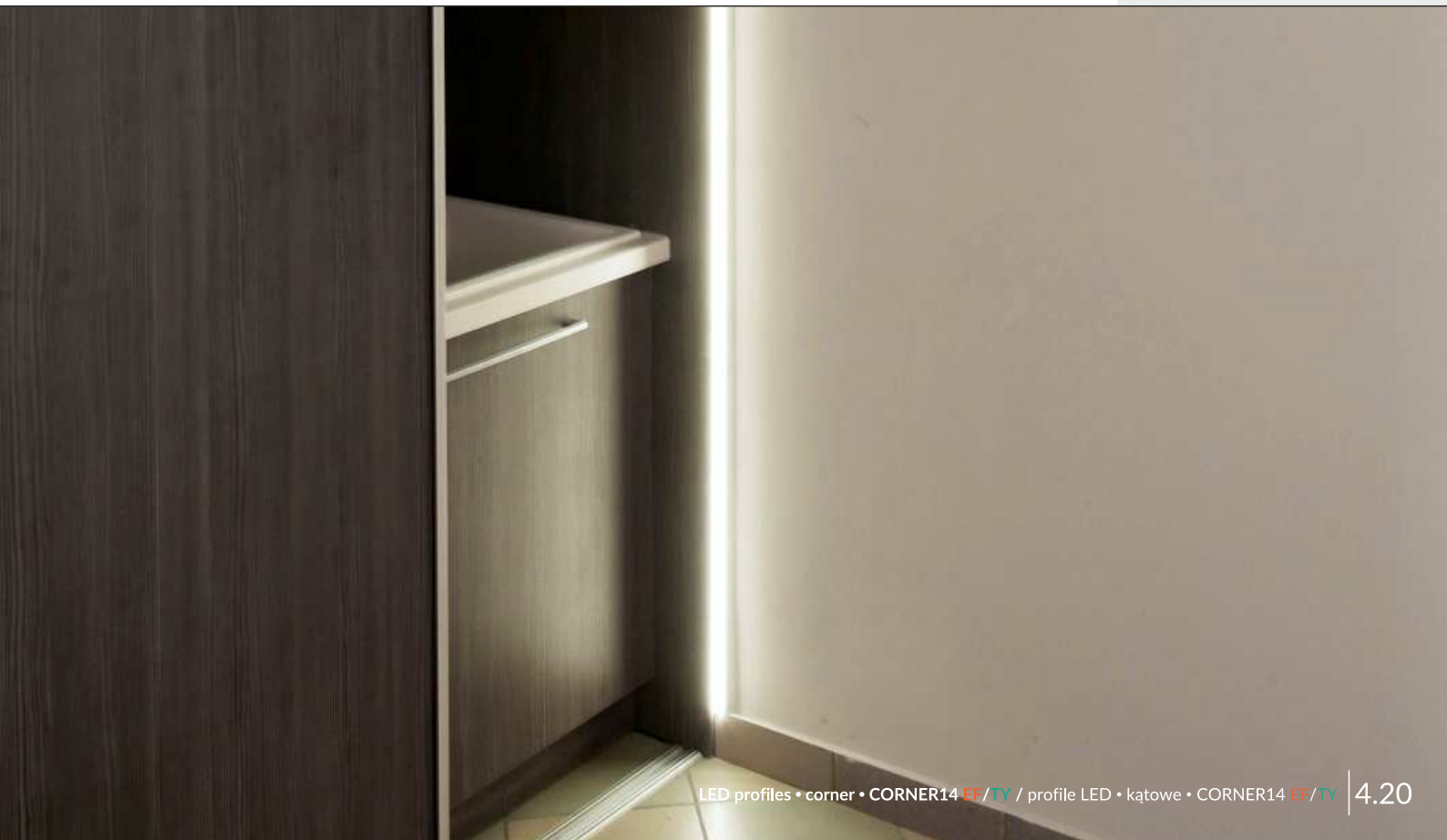

CORNER27 G/UX

LARGE-SIZE ANGULAR PROFILE

WIELKOGABARYTOWY PROFIL KĄTOWY

- lighting profile - possibility of high lumen output
- hidden mounting
- two lighting angles: 30° or 60°
- maximum LED strip width: 27 mm or 3 standard strips (8 mm)
- profil oświetleniowy - możliwość uzyskania dużej wydajności
- ukryte mocowanie
- dwa kąty świecenia: 30 i 60°
- maksymalna szerokość taśmy LED: 27 mm albo do 3 taśm standardowych (8 mm)

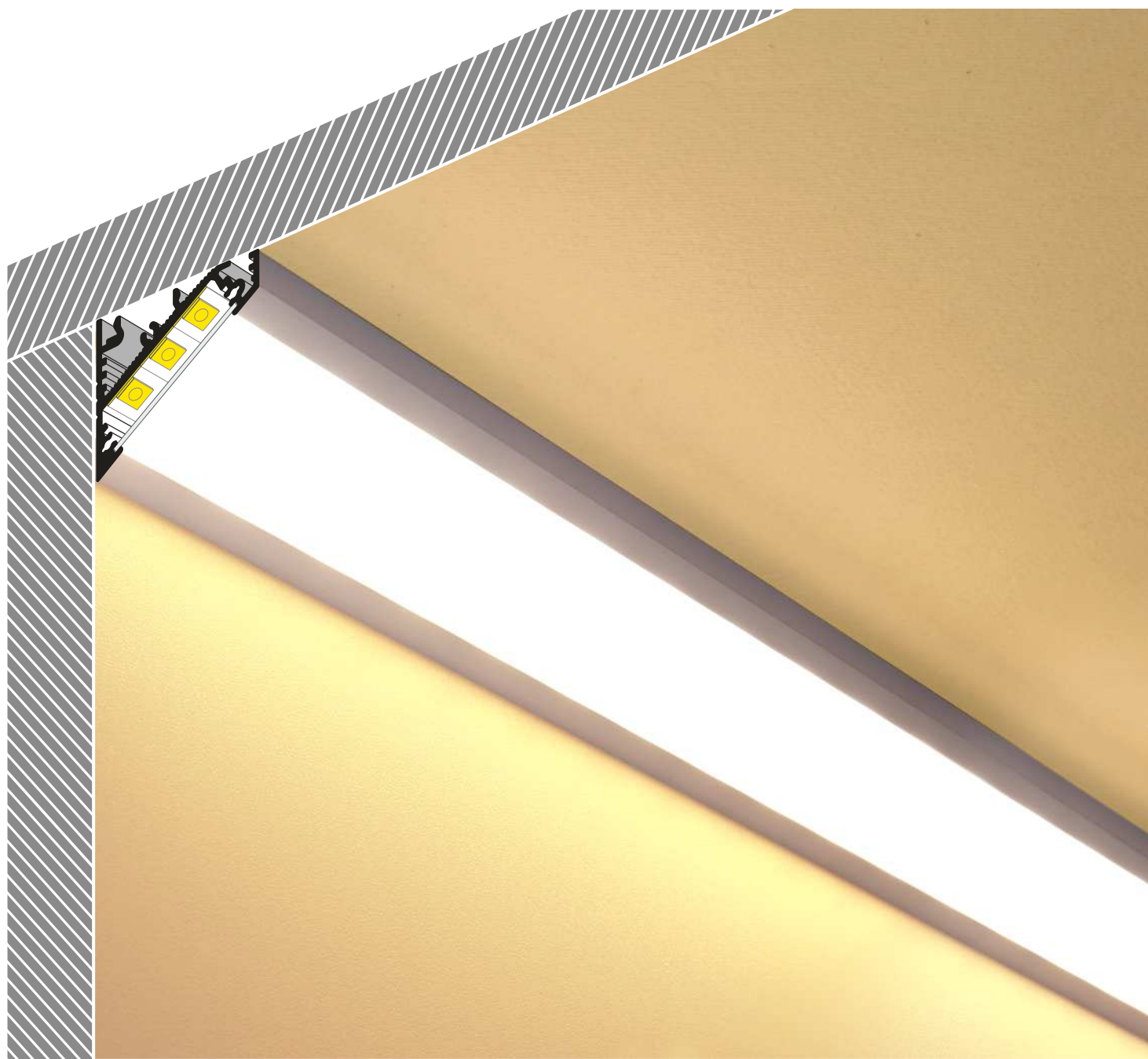

SIMILAR IN THE OFFER / PODOBNE W OFERCIE



TRIO10
BC



CORNER10
BC/UX



QUARTER10
BD/U6



CABI12
E



CORNER14
EF/TY



G slide cover
klosz G wsuwany

U¹ flexible mounting plate
uchwyt U sprężysty

U² cone U flexible mounting plate
uchwyt U sprężysty cone

X¹ X mounting plate
uchwyt X

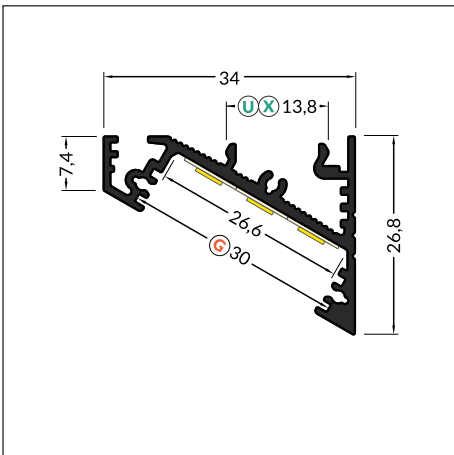
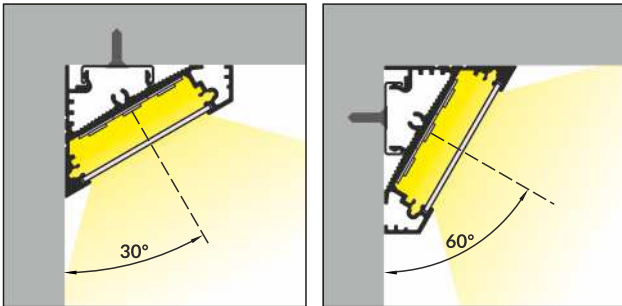
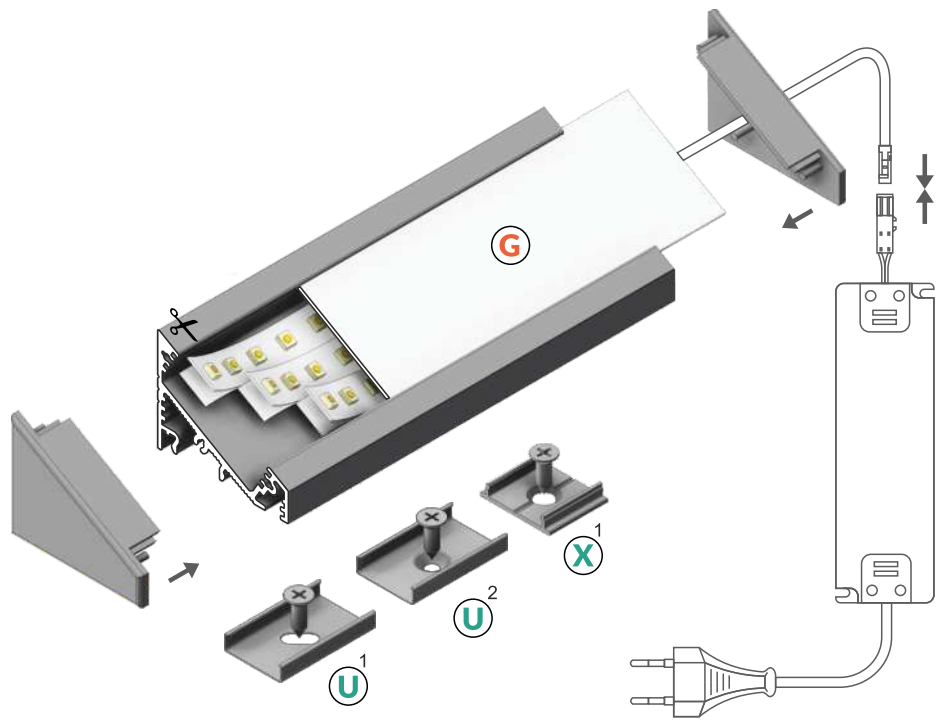

INDEX = 1 pc, length 2000 mm
package = 10 pcs
INDEKS = 1 szt., długość 2000 mm
opakowanie = 10 szt.

○ white painted
biały malowany
98030001



● anodized
anodowany
98030020



● black anodized
czarny anodowany
98030021

Available lengths / Dostępne długości
1000 mm, 2000 mm, 3000 mm, 4000 mm

max 27 mm

corner
kątowy



COVERS / KLOSZE

G slide cover
colours: transparent, frosted, white
material: PC, PP, PP

klosz **G** wsuwany
kolory: transparentny, szron, mleczny
materiał: PC, PP, PP

Note! Dimensions of the space
to install LED source
Uwaga! Wymiary przestrzeni
do zamontowania źródła LED

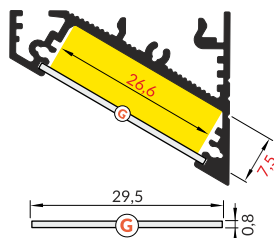

INDEX = 1 pc, length 2000 mm
package = 10 pcs
INDEKS = 1 szt., długość 2000 mm
opakowanie = 10 szt.

G transparent / G transparentny
84070016

G frosted / G szron
84070039

G white / G mleczny
84070038

ENDINGS / ZAŚLEPKI

CORNER27 ending
colours: white, silver, black, grey
material: ABS

zaślepka CORNER27
kolory: biały, srebrny, czarny, szary
materiał: ABS

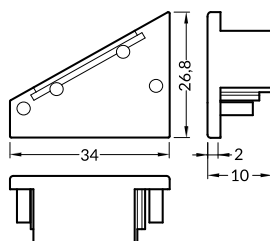

INDEX = 1 set,
package of 10 sets = 20 pcs
INDEKS = 1 komplet, opakowanie
zawiera 10 kompletów = 20 szt.

white
białe 98050001

silver
srebrne 98050040

black
czarne 98050002

grey
szare 98050022

MOUNTINGS / MOCOWANIA

U flexible mounting plate
colour: inox
material: stainless steel

uchwyt **U** sprężysty
kolor: inox
materiał: stal nierdzewna

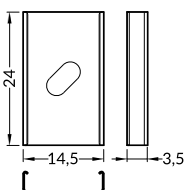
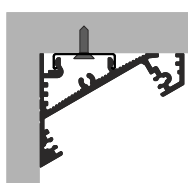

INDEX = 1 set
package of 10 sets = 20 pcs
INDEKS = 1 komplet
opakowanie zawiera 10 kpl = 20 szt

U flexible mounting plate
uchwyt **U** sprężysty

inox
inox
76380000

cone U flexible mounting plate
colour: inox
material: stainless steel

uchwyt **U** sprężysty cone
kolor: inox
materiał: stal nierdzewna

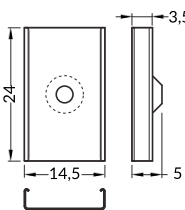
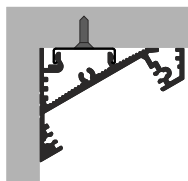

cone U flexible mounting plate
uchwyt **U** sprężysty cone

inox
inox
76620000

X mounting plate
colour: raw aluminium
material: aluminium

uchwyt **X**
kolor: surowe aluminium
materiał: aluminium

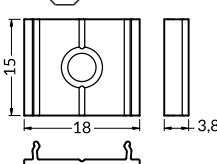
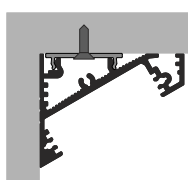

X mounting plate
uchwyt **X**

raw aluminium
surowe aluminium
76260000

CONNECTORS / ŁĄCZNIKI

X connector 180 deg
colour: raw aluminium
material: aluminium

łącznik **X** 180 st
kolor: surowe aluminium
materiał: aluminium

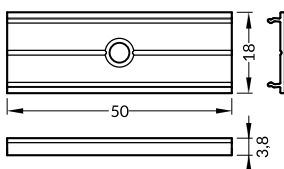

INDEX = 1 set
INDEKS = 1 komplet

raw aluminium
surowe aluminium
76350000





SPECIAL APPLICATION
SPECJALNE

2018

LED profiles
profile LED

PEN8 |

MULTI-PURPOSE ALUMINIUM PROFILE

ALUMINOWY PROFIL UNIWERSALNY

- decorative and lighting profile, eg. for glass cabinets
- 9 types of mountings: for horizontal or vertical lighting (also with adjustment)
- possibility of mounting between the walls of a cabinet
- maximum LED strip width: 8 mm

- profil dekoracyjno-oświetleniowy, np. do szklanych gablot
- 9 rodzajów mocowań: do oświetlania pionowego lub poziomego (również z regulacją)
- możliwość mocowania pomiędzy ściankami
- maksymalna szerokość taśmy LED: 8 mm

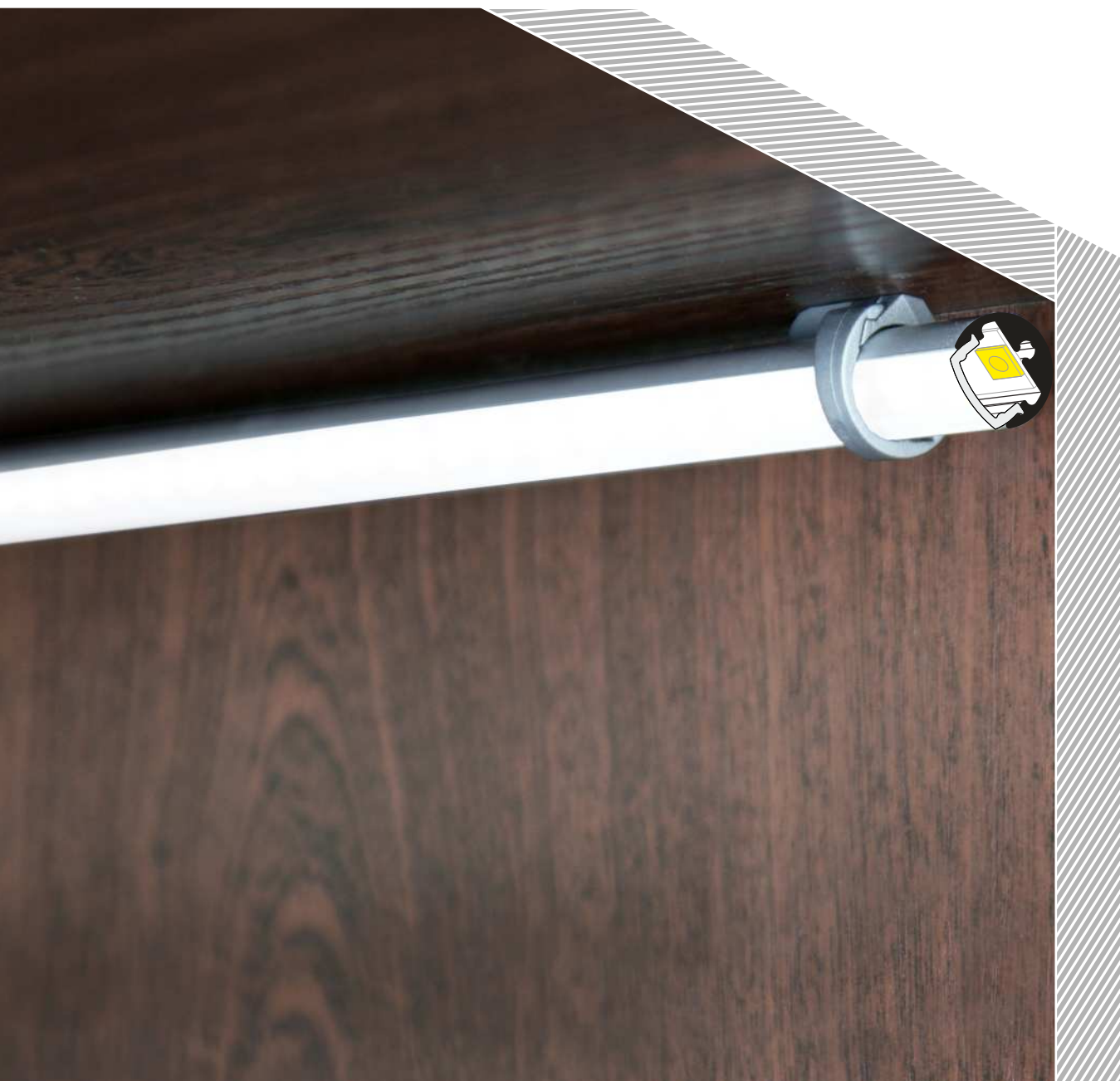

SIMILAR IN THE OFFER / PODOBNE W OFERCIE

SMART10
A/Z

CABI12
E

CORNER10
BC/UX

TRIO10
BC

OVAL20
BC



I click cover
klosz I klik

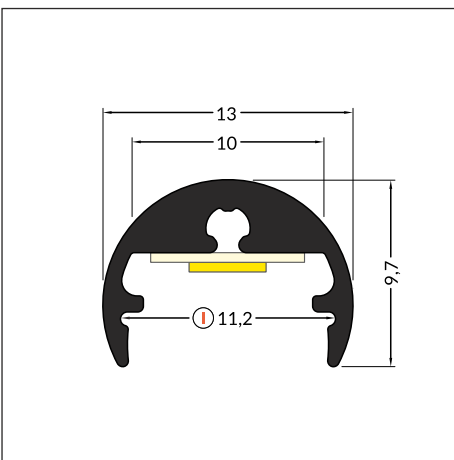
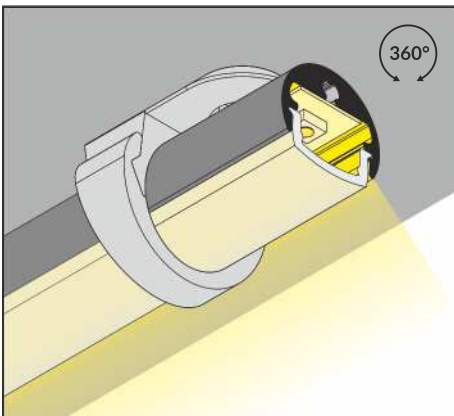
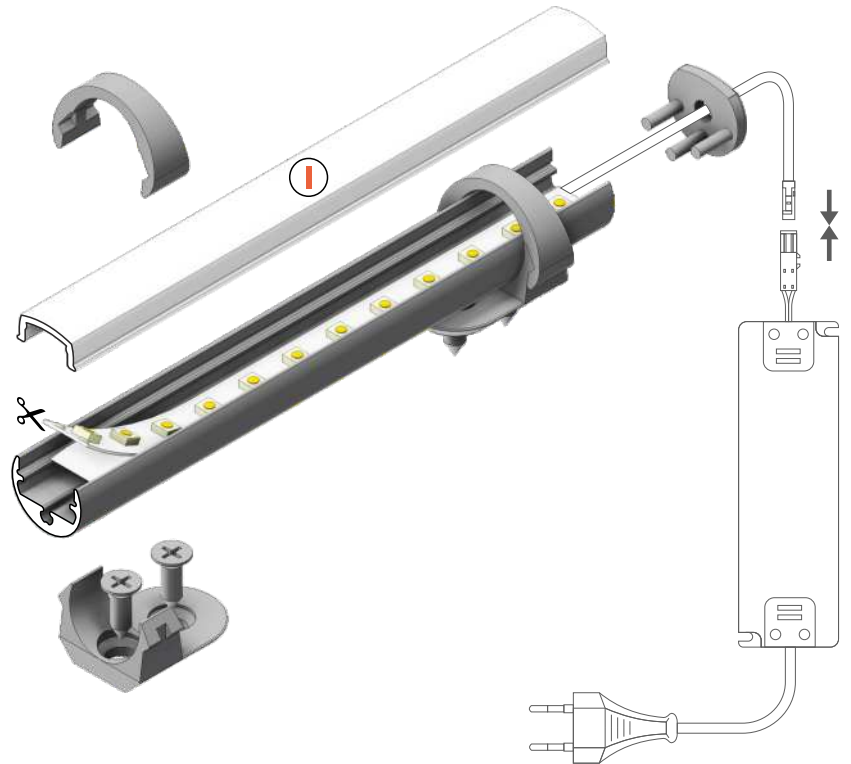

max 8 mm



special application
specjalny

INDEX = 1 pc, length 2000 mm
package = 10 pcs
INDEKS = 1 szt., długość 2000 mm
opakowanie = 10 szt.



anodized
anodowany
86030020

Available lengths / Dostępne długości
1000 mm, 2000 mm, 3000 mm, 4000 mm



COVERS / KLOSZE

click cover
colour: frosted, white
material: PC

klosz | klik
kolor: szron, mleczny
materiał: PC



Note! Dimensions of the space to install LED source
Uwaga! Wymiary przestrzeni do zamontowania źródła LED

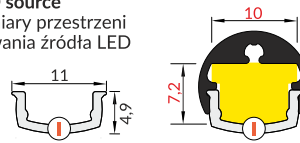

INDEX = 1 pc, length 2000 mm
package = 10 pcs
INDEKS = 1 szt., długość 2000 mm
opakowanie = 10 szt.

| frosted / | szron
86060000

| white / | mleczny
86060038

ENDINGS / ZAŚLEPKI

PEN8 ending
colours: silver, grey
material: ABS

zaślepka PEN8
kolory: srebrny, szary
materiał: ABS

PEN8 ending with hole
colours: silver, grey
material: ABS

zaślepka PEN8 z otworem
kolory: srebrny, szary
materiał: ABS

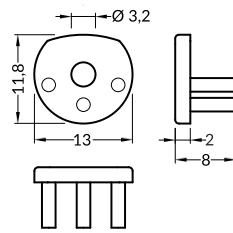

INDEX = 1 set
package of 10 sets = 20 pcs
INDEKS = 1 komplet, opakowanie
zawiera 10 kompletów = 20 szt.

● silver
srebrne

with hole
z otworem
86470040

without hole
bez otworu
86490040

● grey
szare

with hole
z otworem
86470022

without hole
bez otworu
86490022

MOUNTINGS / MOCOWANIA

PEN8 flat holder
colour: grey
material: ABS

uchwyt PEN8 płaski
kolor: szary
materiał: ABS

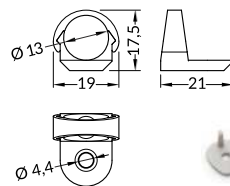
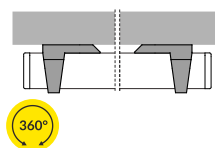

INDEX = 1 set
package of 10 sets = 20 pcs
INDEKS = 1 komplet
opakowanie zawiera 10 kpl = 20 szt

flat holder
uchwyt płaski

● grey
szary
86070022

PEN8 simple holder
material: zinc coated steel

uchwyt PEN8 prosty
materiał: stal ocynkowana

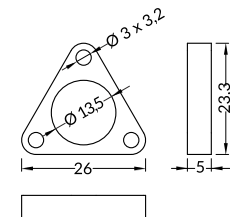
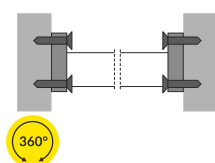

INDEX = 1 set
INDEKS = 1 komplet

simple holder
uchwyt prosty

● zinc coated
stal ocynkowana
86370030

PEN8 stretcher holder
colour: chrome
material: brass

uchwyt PEN8 rozporowy
kolor: chrom
materiał: mosiądz

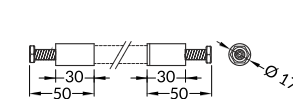
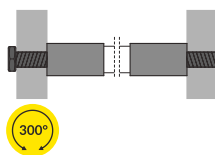

stretcher holder
uchwyt rozporowy

● chrome
chrom
86290003

PEN8 end holder
colour: chrome
material: brass

uchwyt PEN8 końcowy
kolor: chrom
materiał: mosiądz

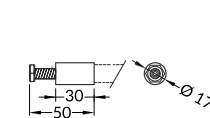
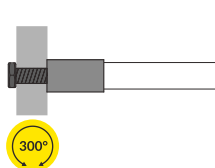

end holder
uchwyt końcowy

● chrome
chrom
86160003

PEN8 ring holder
colours: chrome, raw
material: brass

uchwyt PEN8 ring
kolory: chrome, surowy
materiał: mosiądz

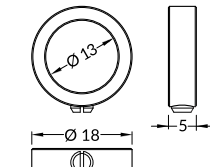
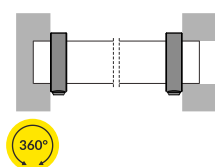

ring holder
uchwyt ring

● chrome
chrom
86440003



MOUNTINGS / MOCOWANIA

PEN8 jointed holder with thread
colour: chrome
material: steel, brass

uchwyt PEN8 przegubowy z gwintem
kolor: chrom
materiał: stal, mosiądz

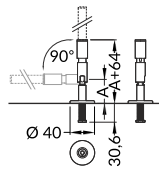

| A = | INDEX = 1 set INDEKS = 1 kpl |
|---------|---------------------------------|
| 39,4 mm | 86090003 |
| 100 mm | 86310003 |
| 200 mm | 86110003 |
| 300 mm | 86130003 |

PEN8 jointed holder with soffit ceiling
colour: chrome
material: steel, brass

uchwyt PEN8 przegubowy z podsufitką
kolor: chrom
materiał: stal, mosiądz

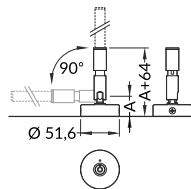

| A = | INDEX = 1 set INDEKS = 1 kpl |
|--------|---------------------------------|
| 27 mm | 86080003 |
| 100 mm | 86300003 |
| 200 mm | 86100003 |
| 300 mm | 86120003 |

PEN8 double holder with thread
colour: chrome
material: steel, brass

uchwyt PEN8 podwójny z gwintem
kolor: chrom
materiał: stal, mosiądz

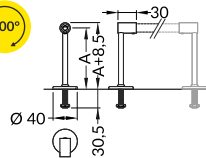

| A = | INDEX = 1 set INDEKS = 1 kpl |
|--------|---------------------------------|
| 100 mm | 86330003 |
| 200 mm | 86180003 |
| 300 mm | 86200003 |

PEN8 double holder with soffit ceiling
colour: chrome
material: steel, brass

uchwyt PEN8 podwójny z podsufitką
kolor: chrom
materiał: stal, mosiądz

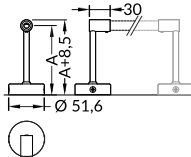

| A = | INDEX = 1 set INDEKS = 1 kpl |
|--------|---------------------------------|
| 100 mm | 86320003 |
| 200 mm | 86170003 |
| 300 mm | 86190003 |

Photo / Zdjęcie:
PORS - Systemy Meblowe Mirosław Krysiak



BACK10 A/UX

TWO LIGHTING DIRECTIONS

DWA KIERUNKI ŚWIECENIA

- decorative and lighting profile
 - the T-shaped structure makes possible to direct the light beam in two directions (up/down, left/right)
 - mounting with two dedicated holders (to the wall) or directly to the piece of furniture, using screws
 - optionally, the A cover can be used
 - maximum LED strip width: 10 mm
-
- profil dekoracyjno-oświetleniowy
 - konstrukcja w kształcie litery "T" pozwala na skierowanie strumienia świetlnego w dwóch kierunkach (góra/dół, lewo/prawo)
 - mocowanie za pomocą dedykowanych uchwytów (do ściany) lub bezpośrednio przy pomocy wkrętów (do mebla)
 - opcjonalne użycie klosza A
 - maksymalna szerokość taśmy LED: 10 mm

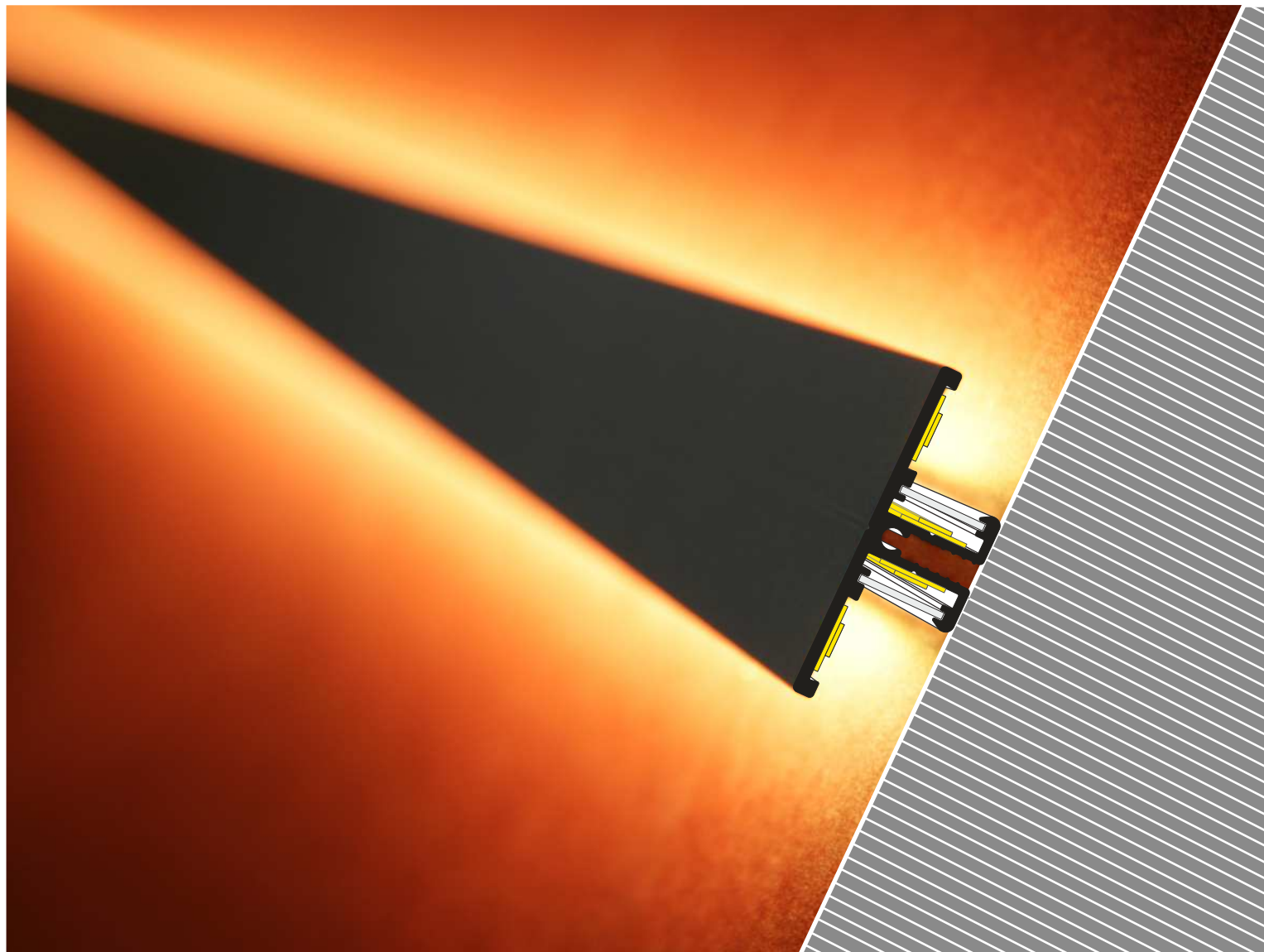

SIMILAR IN THE OFFER / PODOBNE W OFERCIE



TWIN8



AMBI12

C



WALLE12

CD



- A** slide cover
klosz A wsuwany
- U¹** U flexible mounting plate
uchwyt U sprężysty
- U²** cone U flexible mounting plate
uchwyt U sprężysty cone
- X¹** X mounting plate
uchwyt X

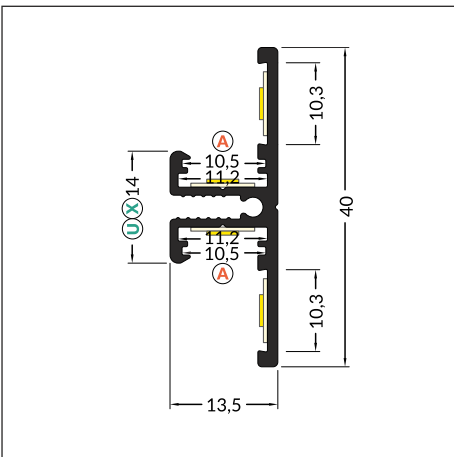
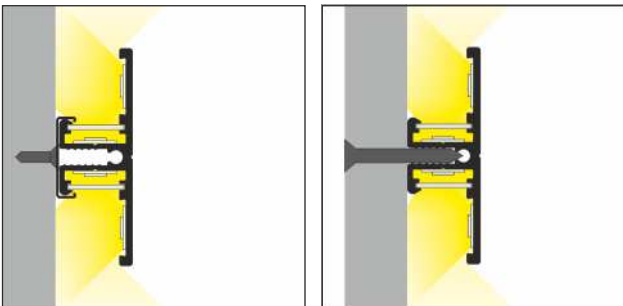
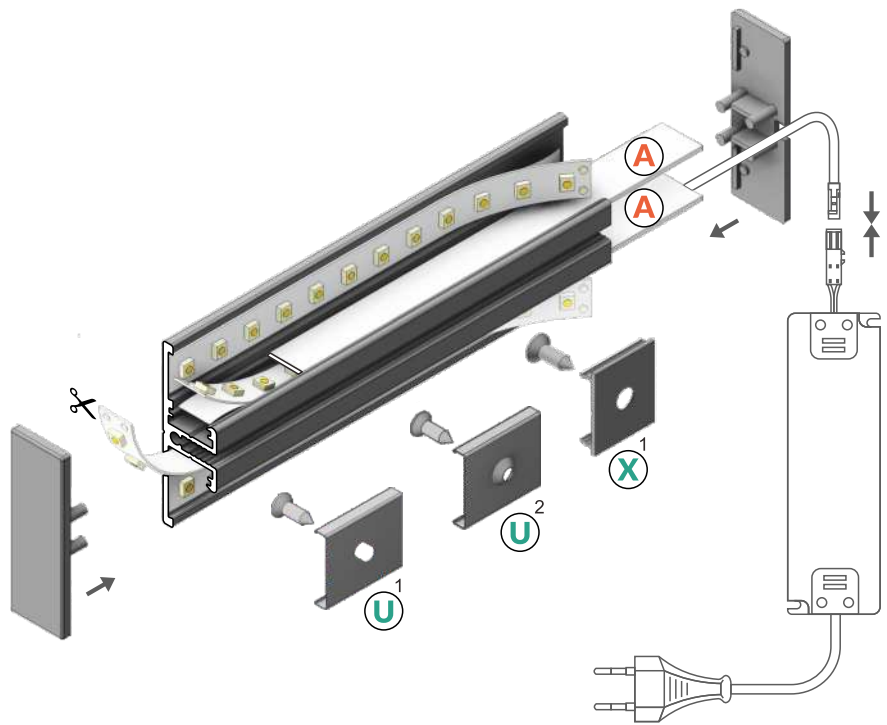

max 10 mm



special application
specjalny



INDEX = 1 pc, length 2000 mm
package = 10 pcs
INDEKS = 1 szt., długość 2000 mm
opakowanie = 10 szt.



white painted
biały malowany
90030001



anodized
anodowany
90030020



black painted
czarny malowany
90030002



raw aluminium
surowe aluminium
90030000

Available lengths / Dostępne długości
1000 mm, 2000 mm, 3000 mm, 4000 mm



COVERS / KLOSZE

A slide cover

colours: transparent, frosted, white
material: PC, PP, PP

klosz A wsuwany
kolory: transparentny, szron, mleczny
materiał: PC, PP, PP

Note! Dimensions of the space to install LED source
Uwaga! Wymiary przestrzeni do zamontowania źródła LED

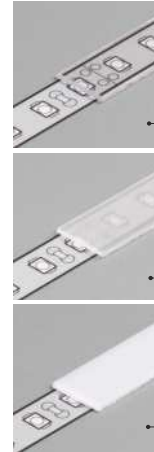
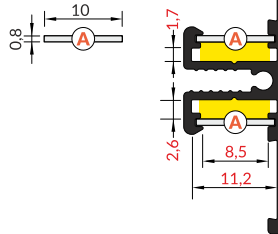

INDEX = 1 pc, length 2000 mm
package = 10 pcs
INDEKS = 1 szt., długość 2000 mm
opakowanie = 10 szt.

A transparent / A transparentny
89070016

A frosted / A szron
89070039

A white / A mleczny
89070038

ENDINGS / ZAŚLEPKI

BACK10 ending

colours: white, silver, black, grey
material: ABS

zaślepka BACK10

kolory: biały, srebrny, czarny, szary
materiał: ABS

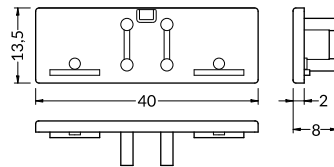

BACK10 ending with hole

colours: white, silver, black, grey
material: ABS

zaślepka BACK10 z otworem

kolory: biały, srebrny, czarny, szary
materiał: ABS

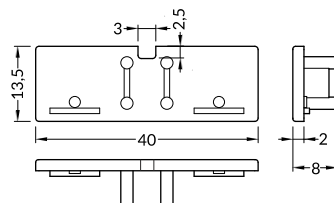

INDEX = 1 set
package of 10 sets = 20 pcs
INDEKS = 1 komplet, opakowanie
zawiera 10 kompletów = 20 szt.

white
białe

with hole z otworem 90150001 | without hole bez otworu 90100001

silver
srebrne

with hole z otworem 90150040 | without hole bez otworu 90100040

black
czarne

with hole z otworem 90150002 | without hole bez otworu 90100002

grey
szare

with hole z otworem 90150022 | without hole bez otworu 90100022

MOUNTINGS / MOCOWANIA

U flexible mounting plate

colour: inox
material: stainless steel

uchwyt U sprężysty

color: inox
materiał: stal nierdzewna

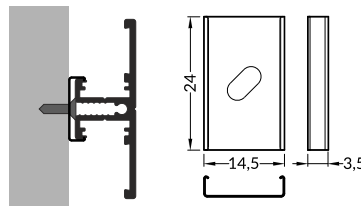

INDEX = 1 set
package of 10 sets = 20 pcs
INDEKS = 1 komplet
opakowanie zawiera 10 kpl = 20 szt.

U flexible mounting plate
uchwyt U sprężysty

inox 76380000

cone U flexible mounting plate

colour: inox
material: stainless steel

uchwyt U sprężysty cone

color: inox
materiał: stal nierdzewna

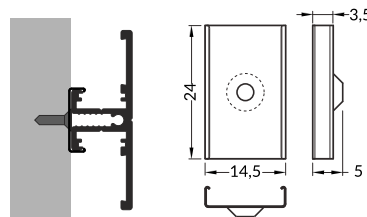

cone U flexible mounting plate
uchwyt U sprężysty cone

inox 76620000

X mounting plate

colour: raw aluminium
material: aluminium

uchwyt X

color: surowe aluminium
materiał: aluminium

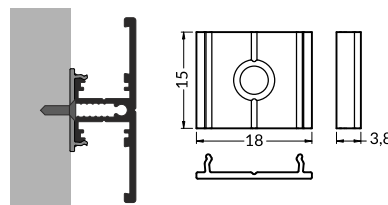

X mounting plate
uchwyt X

raw aluminium
surowe aluminium
76260000



CONNECTORS / ŁĄCZNIKI

X connector 180 deg
colour: raw aluminium
material: aluminium

łącznik X 180 st
kolor: surowe aluminium
materiał: aluminium

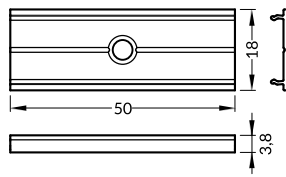

INDEX = 1 set
INDEKS = 1 komplet

 raw aluminium
surowe aluminium
76350000



STEP10 C

STEP EDGE PROFILE

PROFIL SCHODOWY KRAWĘDZIOWY

- highlighting or illuminating feature
- 2 mounting options - 3 lighting options to choose from
- anti slip insert installation option
- hidden mounting
- impact resistant
- maximum LED strip width: 10 mm
- światlenie akcentujące lub oświetleniowe
- 2 opcje montażu - 3 opcje świecenia do wyboru
- opcja montażu wkładki antypoślizgowej
- ukryte mocowanie
- odporny na udary
- maksymalna szerokość taśmy LED: 10 mm

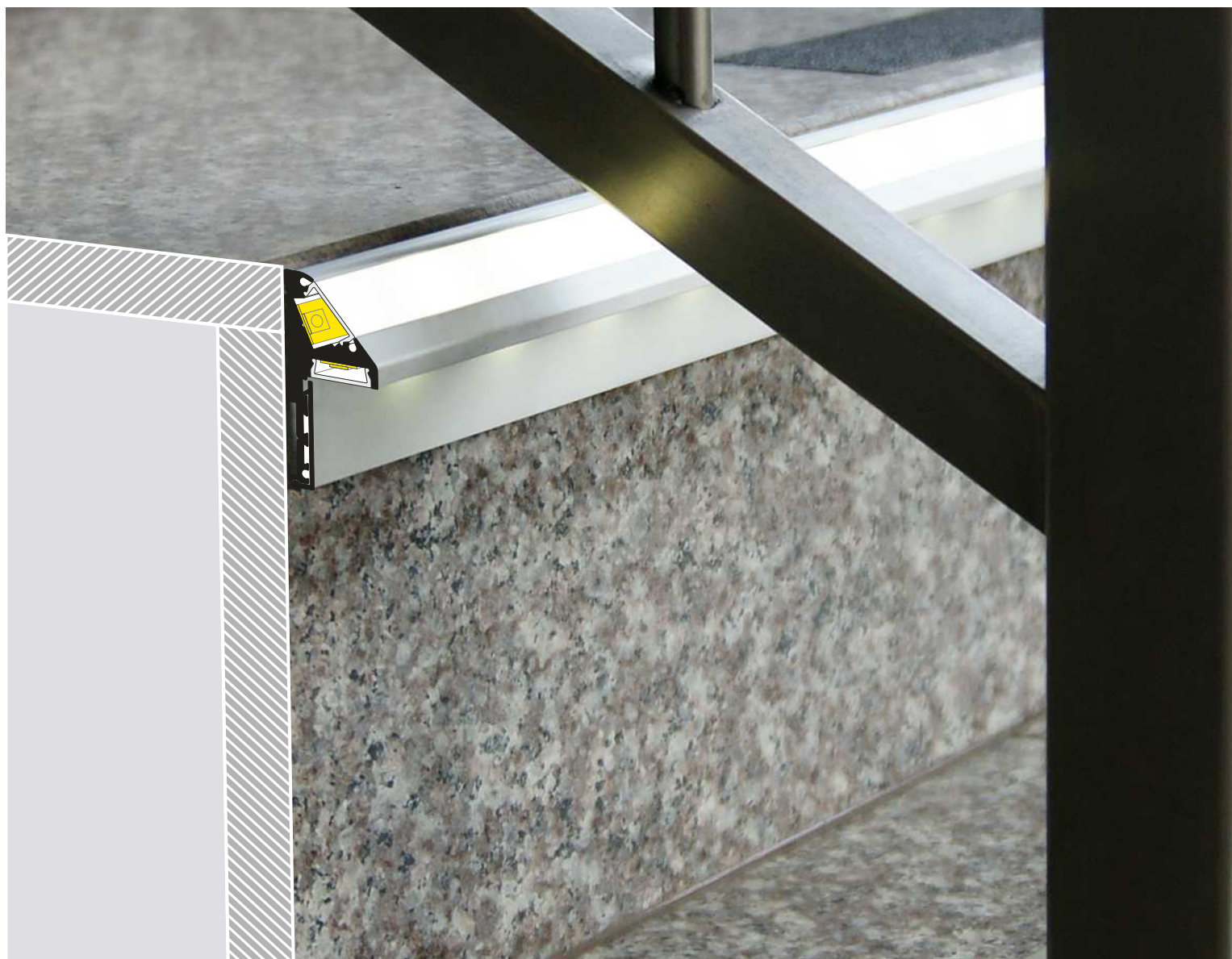

SIMILAR IN THE OFFER / PODOBNE W OFERCIE



FLOOR12
K/U



OUTSTAIRS12
BC



C click cover
klosz C klik

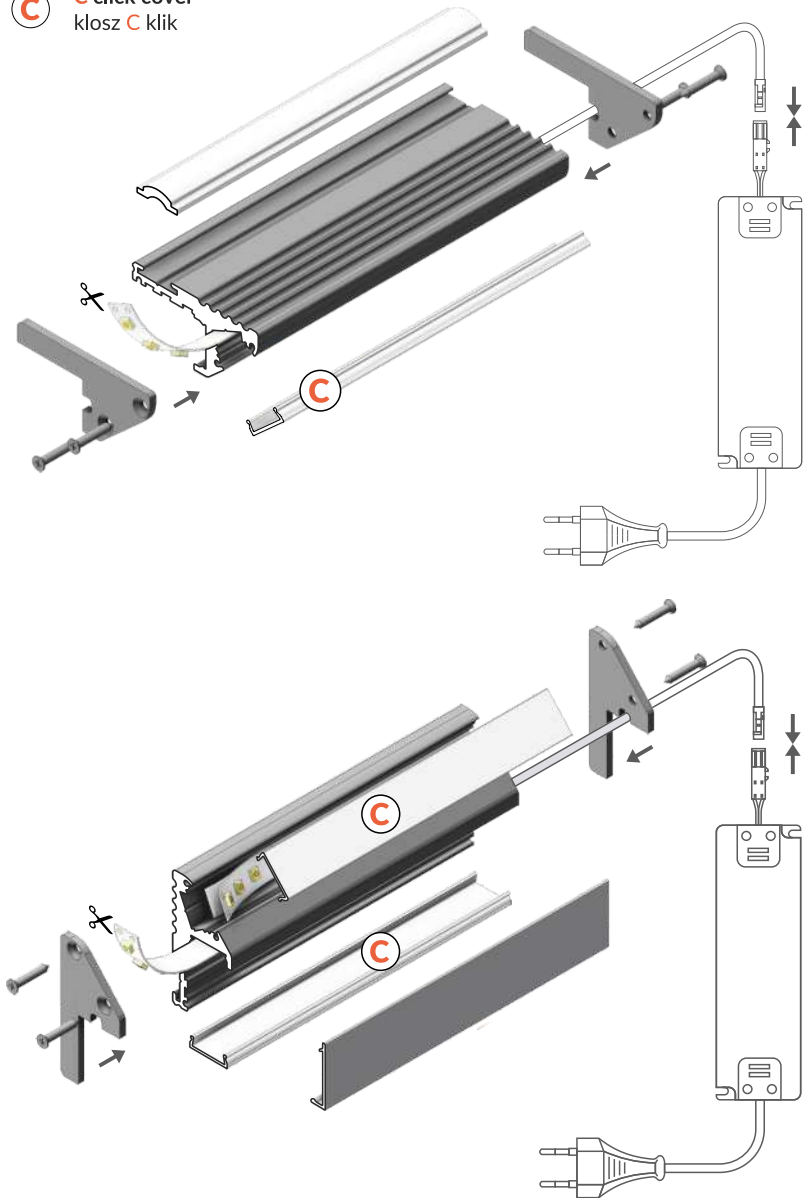
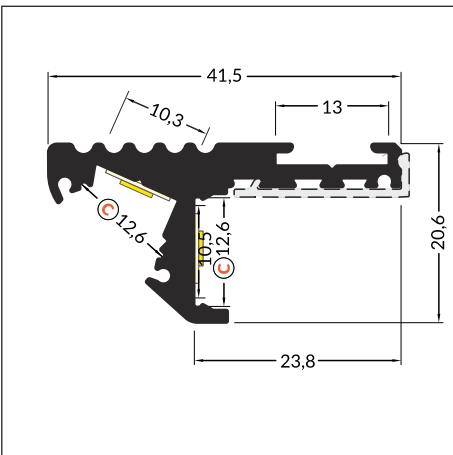
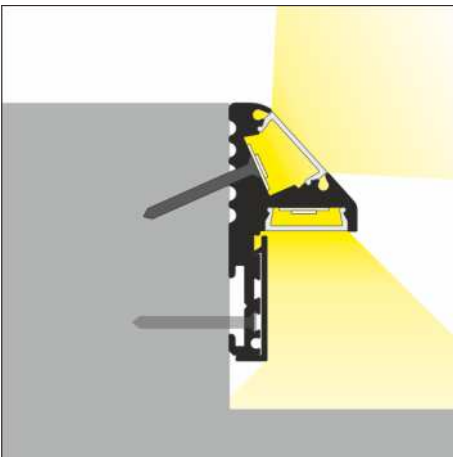
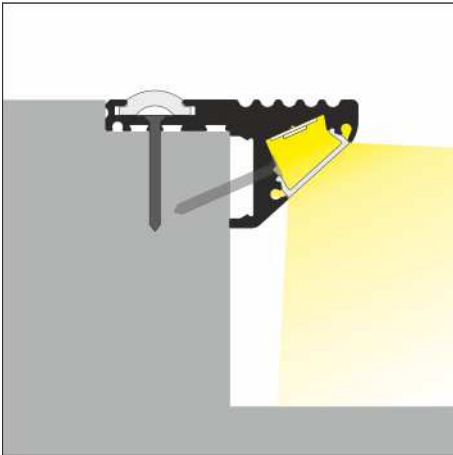

INDEX = 1 pc, length 2000 mm
package = 10 pcs
INDEKS = 1 szt., długość 2000 mm
opakowanie = 10 szt.

 anodized
anodowany
32080020

 black anodized
czarny anodowany
32080021

Available lengths / Dostępne długości
1000 mm, 2000 mm, 3000 mm, 4000 mm

 max 10 mm

 special application
specjalny



COVERS / KLOSZE

C click cover
colours: transparent, white
material: PMMA

klosz C klik
kolory: transparentny, mleczny
materiał: PMMA



Note! Dimensions of the space
to install LED source
Uwaga! Wymiary przestrzeni
do zamontowania źródła LED

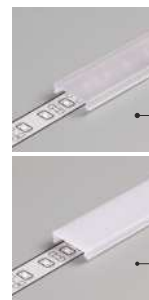
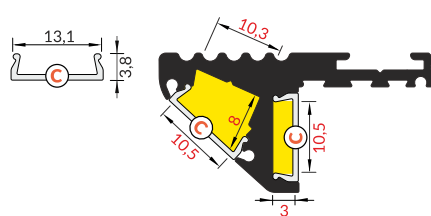

INDEX = 1 pc, length 2000 mm
package = 10 pcs
INDEKS = 1 szt., długość 2000 mm
opakowanie = 10 szt.

C transparent / C transparentny
76330000

C white / C mleczny
76330038

ENDINGS / ZAŚLEPKI

STEP10 ending
colours: silver, black
material: steel

zaślepka STEP10
kolory: srebro, czarny
materiał: stal

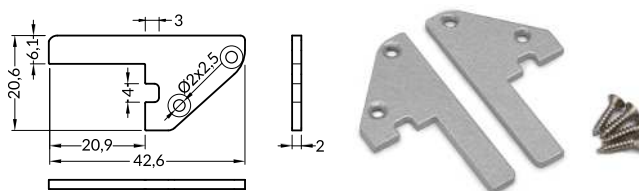

INDEX = 1 set = 2 pcs
INDEKS = 1 komplet = 2 szt.

silver
srebro
32100022

black
czarny
32100002

COVER / OSŁONA

STEP10 LED cover
colours: anodized, black
material: aluminium

osłona LED STEP10
kolory: anodowany, czarny
materiał: aluminium

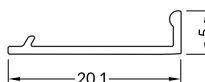

INDEX = 1 pc, length 2000 mm
package = 10 pcs
INDEKS = 1 szt., długość 2000 mm
opakowanie = 10 szt.

anodized
anodowany
32120020

black anodized
czarny anodowany
32120021

INSERT / WKŁADKA

STEP10 anti slip insert
colours: transparent, black

wkładka antypoślizgowa STEP10
kolory: transparentny, czarny



INDEX = 1 pc, length 2000 mm
package = 10 pcs
INDEKS = 1 szt., długość 2000 mm
opakowanie = 10 szt.

transparent
transparentny
32150000

black
czarny
32150002

1. Illuminating a step with anti slip insert applied.

1. Oświetlenie stopnia oraz zastosowanie wkładki antypoślizgowej.



2. Illuminating a step and edge highlighting.

2. Oświetlenie stopnia oraz zaakcentowanie krawędzi.



AMBI12 C

ALUMINIUM LED PROFILE FOR CREATING LUMINAIRES

ALUMINIOWY PROFIL LED DO TWORZENIA OPRAW OŚWIETLENIOWYCH

- lighting and decorative profile
- maximum LED strip width: 12 mm
- profil oświetleniowo-dekoracyjny
- maksymalna szerokość taśmy LED: 12 mm



SIMILAR IN THE OFFER / PODOBNE W OFERCIE



FLAT8
H/UX



BACK10
A/UX



MIKRO10



MIKRO-LINE12



C click cover
klosz **C** klik

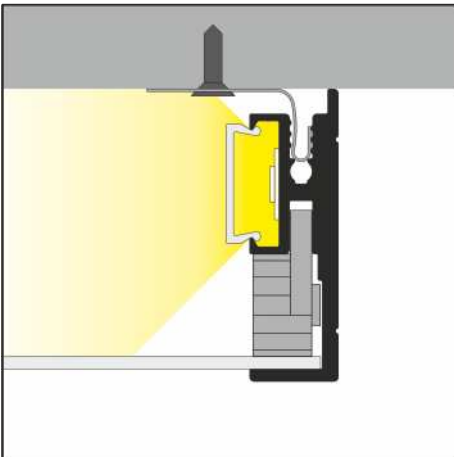
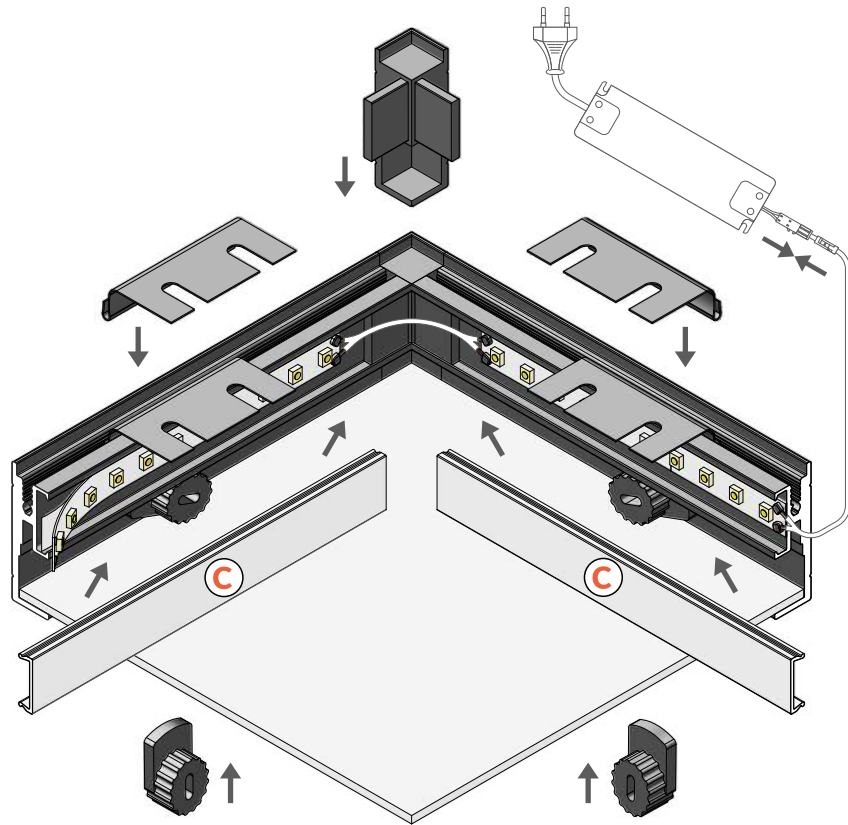

INDEX = 1 pc,
package = 10 pcs
INDEKS = 1 szt.,
opakowanie = 10 szt.

○ white painted
biały malowany

110 mm
575 mm
1000 mm
2000 mm

B3520001
B3540001
B3500001
B3510001

● anodized
anodowany

110mm
575 mm
1000 mm
2000 mm

B3520020
B3540020
B3500020
B3510020



Available lengths / Dostępne długości
110 mm, 575 mm, 1000 mm, 2000 mm,
3000 mm, 4000 mm

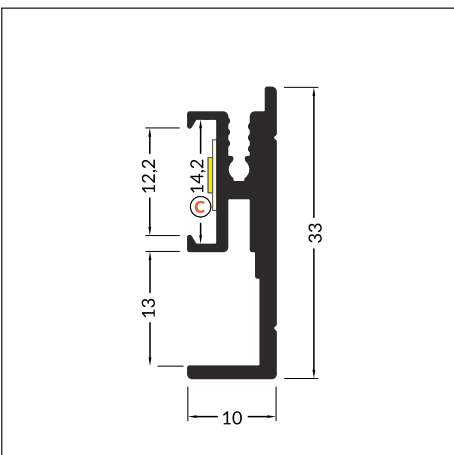

○ max 12 mm

□ special application
specjalny



COVERS / KLOSZE

C click cover
colours: transparent, white
material: PMMA

klosz C klik
kolory: transparentny, mleczny
materiał: PMMA

AMBI12 cover
colour: white
material: PET

klosz AMBI12
kolor: mleczny
materiał: PET

cover 590x590x1,5
colour: white
material: PS

klosz 590x590x1,5
kolor: mleczny
materiał: PS



Note! Dimensions of the space
to install LED source
Uwaga! Wymiary przestrzeni
do zamontowania źródła LED

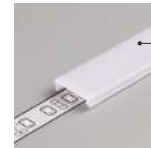
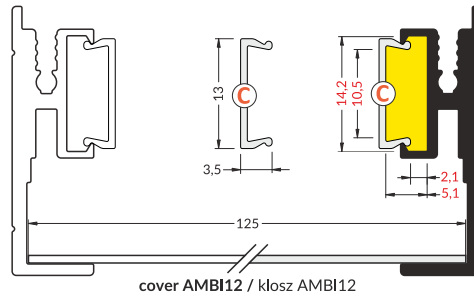

INDEX = 1 pc
package = 10 pcs
INDEKS = 1 szt.
opakowanie = 10 szt.

C transparent / C transparentny
1000 mm 76320000
2000 mm 76330000

C white / C mleczny
1000 mm 76320038
2000 mm 76330038

INDEX = 1 pc
INDEKS = 1 szt.
white cover / klosz mleczny
1010 x 125 mm B3500038
2010 x 125 mm B3501038
590 x 590 mm B3503038

CONNECTOR / ŁĄCZNIK

AMBI12 connector 90 deg
colour: white
material: ABS

łącznik AMBI12 90 st
kolor: biały
materiał: ABS

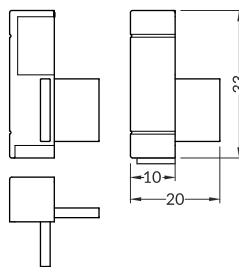

INDEX = 1 set = 4 pcs
INDEKS = 1 komplet = 4 szt.

white
białe B3990001

grey
szare B3990022

silver
srebro B3990040

CLAMP / DOCISK

AMBI12 clamp
colours: white, grey
material: ABS

docisk AMBI12
kolory: biały, szary
materiał: ABS

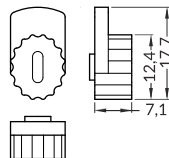

INDEX = 1 set = 4 pcs
INDEKS = 1 komplet = 4 szt.

white
białe B3970001

MOUNTING / MOCOWANIE

AMBI12 flexible holder
colour: inox
material: stainless steel

uchwyt AMBI12 sprężysty
kolor: inox
materiał: stal nierdzewna

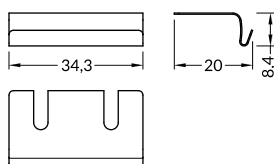

INDEX = 1 set = 4 pcs
INDEKS = 1 komplet = 4 szt.

inox
inox B3960019

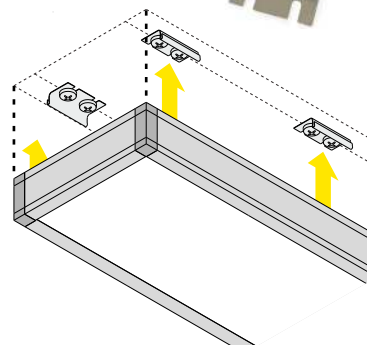
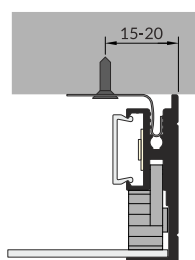



LED profile AMBI12 and dedicated diffusers allows to create decorative luminaires in different dimensions. Depending on the LED strip used, different light effects can be achieved - smooth, edge or more intensive with even lighting surface, that could be strengthened when mounted on a white surface.

Profil LED AMBI12 oraz dedykowane klosze pozwalają na budowanie dekoracyjnych opraw o różnych proporcjach. W zależności od mocy użytej taśmy możliwe jest uzyskanie odmiennych efektów świetlnych: delikatnego, krawędziowego lub intensywniejszego z gładką powierzchnią świecenia, który można dodatkowo wzmocnić montując oprawę na białym podłożu.

ARC12 CD/U5

FLEXIBLE ALUMINIUM LED PROFILE

ALUMINIOWY PROFIL LED DO ZASTOSOWAŃ GIĘTYCH

- flexible aluminium profile - possibility of bending in two directions
- the profile keeps shaped bend
- minimal bending radius: 50 cm
- decorative and illuminating purpose of the profile
- possibility of using two diffusers - better light dispersion
- possible outside installation (with D cover and waterproof LED strip used)
- maximum LED strip width: 12 mm
- aluminiowy profil do zastosowań giętych w dwóch kierunkach jednej płaszczyzny
- profil zachowujący kształt wygięcia
- minimalny promień gięcia: 50 cm
- profil dekoracyjno-oświetleniowy
- możliwość założenia dwóch kloszy - lepsze rozproszenie światła
- możliwość montażu zewnętrznego (przy zastosowaniu klosza D oraz taśmy wodoodpornej)
- maksymalna szerokość taśmy LED: 12 mm



SIMILAR IN THE OFFER / PODOBNE W OFERCIE



SLIM8
A/Z



SMART10
A/Z



BEGTON12
J/S



UNI12
BCD/U



- C** C click cover
klosz C klik
- D** D click cover
klosz D klik
- U5**¹ U5 mounting plate
uchwyt U5
- U5**² side U5 mounting plate
uchwyt U5 boczny

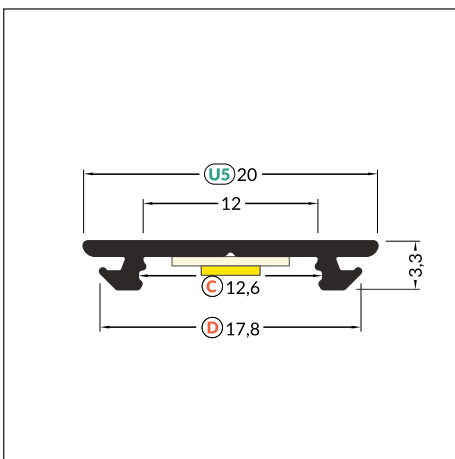
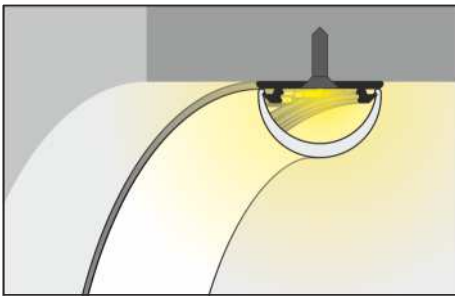
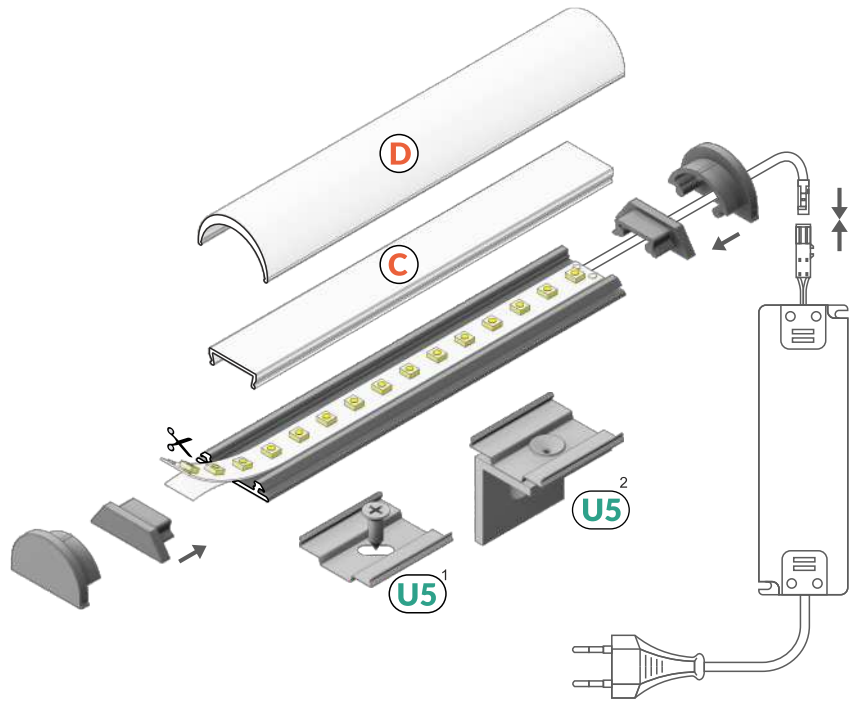

INDEX = 1 pc, length 2000 mm
package = 10 pcs
INDEKS = 1 szt., długość 2000 mm
opakowanie = 10 szt.

○ white painted
biały malowany
B2010001

● anodized
anodowany
B2010020

● black painted
czarny malowany
B2010002

○ raw aluminium
surowe aluminium
B2010000

Available lengths / Dostępne długości
1000 mm, 2000 mm, 3000 mm, 4000 mm

max 12 mm

special application
specjalny



COVERS / KLOSZE

C click cover
colours: transparent, white
material: PMMA

klosz **C** klik
kolory: transparentny, mleczny
materiał: PMMA

D click cover
colour: white
material: PMMA

klosz **D** klik
kolor: mleczny
materiał: PMMA



Note! Dimensions of the space to install LED source
Uwaga! Wymiary przestrzeni do zamontowania źródła LED

Maximum LED strip width while using C cover: 10 mm
Maksymalna szerokość taśmy przy użyciu klosza C: 10 mm

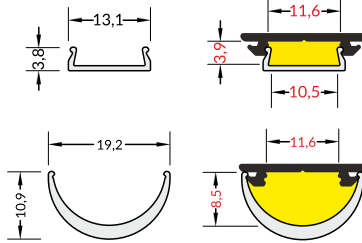

INDEX = 1 pc, length 2000 mm
package = 10 pcs
INDEKS = 1 szt., długość 2000 mm
opakowanie = 10 szt.

C transparent / C transparentny
76330000

C white / C mleczny
76330038

D white / D mleczny
A1140038

ENDINGS / ZAŚLEPKI

ARC12 ending
colours: white, grey, black
material: ABS

zaślepka ARC12
kolory: biały, szary, czarny
materiał: ABS

ARC12 D ending
colours: white, grey, black
material: ABS

zaślepka ARC12 D
kolory: biały, szary, czarny
materiał: ABS



Ending with marked space to bore the holes.
Zaślepka z punktami do przewiercenia otworów.

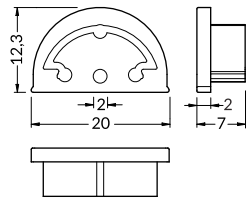
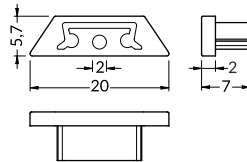

INDEX = 1 set, package of 10 sets = 20 pcs
INDEKS = 1 komplet
opakowanie zawiera 10 kpl = 20 szt

ARC12 ending / zaślepka ARC12

- white biały B2960001
- grey szary B2960022
- black czarny B2960002
- silver srebro B2960040

ARC12 D ending / zaślepka ARC12 D

- white biały B2980001
- grey szary B2980022
- black czarny B2980002
- silver srebro B2980040

MOUNTINGS / MOCOWANIA

cone U5 mounting plate
colour: inox
material: stainless steel

uchwyt **U5** cone
kolor: inox
materiał: stal nierdzewna

side U5 mounting plate
colours: white, silver, black
material: stainless steel, aluminium

uchwyt **U5** boczny
kolory: biały, srebro, czarny
materiał: stal nierdzewna, aluminium

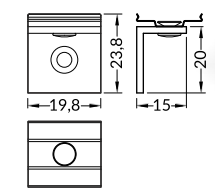
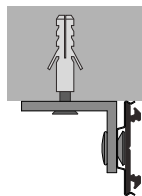
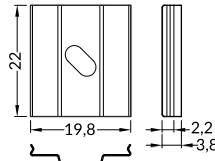

INDEX = 1 set
package of 10 sets = 20 pcs
INDEKS = 1 komplet
opakowanie zawiera 10 kpl = 20 szt

cone **U5** mounting plate
uchwyt **U5** cone

- inox B2940019

side **U5** mounting plate
uchwyt **U5** boczny

- white biały B2920001
- silver srebro B2920022
- black czarny B2920002

SLING / ZAWIESIE

SELV sling 50 V 1500
colour: white, silver, black

zawiesie SELV 50 V 1500
kolor: biały, srebro, czarny

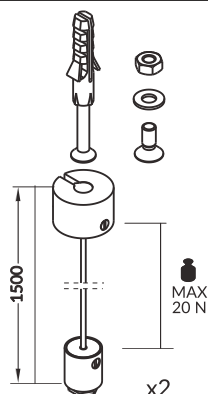

INDEX = 1 set
INDEKS = 1 zestaw

SELV sling 50 V 1500
zawiesie SELV 50 V 1500

- white biały 67120001
- silver srebro 67120022
- black czarny 67120002



FIX12 / FIX16



THE SIMPLEST INSTALLATION OF A LED STRIP

NAJPROSTSZE MOCOWANIE TAŚMY LED

- function of radiator
- improves LED strip's adhesion
- minimal height of the profile
- budget profile, to be used without a cover
- maximum width of LED strip: 12 mm (FIX12) and 16 mm (FIX16)
- it can also function as a mounting profile:
FIX12 for profiles with X socket
FIX16 for profiles with T socket

- funkcja radiatora
- trwalsze przyleganie taśmy LED
- minimalna wysokość profilu
- profil budżetowy, do użycia bez klosza
- maksymalna szerokość taśmy LED: 12 mm (FIX12) oraz 16 mm (FIX16)
- może pełnić również funkcję montażową:
FIX12 dla profili z gniazdem X
FIX16 dla profili z gniazdem T



SIMILAR IN THE OFFER / PODOBNE W OFERCIE

SLIM8
A/Z



SMART10
A/Z

SURFACE10
BC/UX

BEGTON12
J/S

ARC12
CD/R

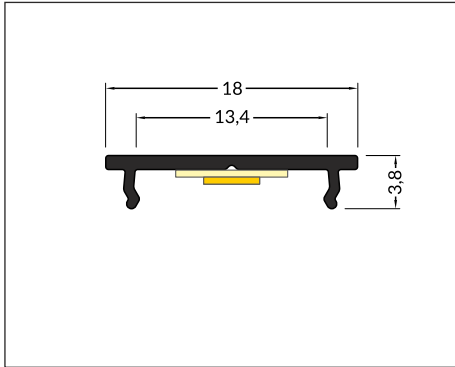
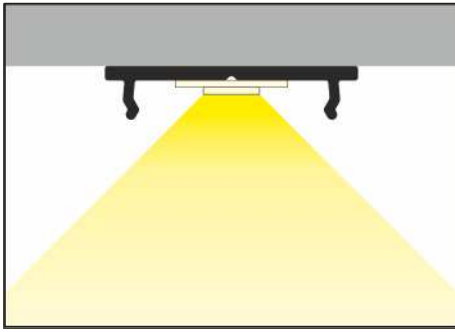
SURFACE14
EF/TY



max 12 mm



special application
specjalny



mounting with screws
or adhesive tape
montaż na wkręty
albo taśmę dwustronną



INDEX = 1 pc, length 2000 mm
package = 10 pcs
INDEKS = 1 szt., długość 2000 mm
opakowanie = 10 szt.



anodized
anodowany
87030020



raw aluminium
surowe aluminium
87030000

Available lengths / Dostępne długości
1000 mm, 2000 mm, 3000 mm, 4000 mm

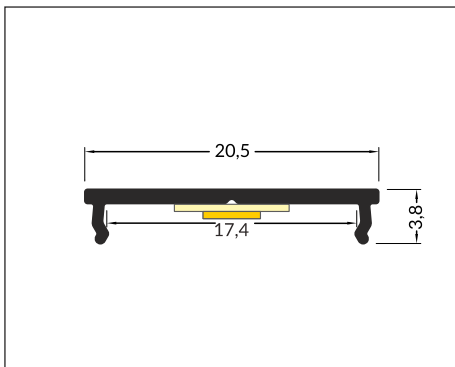
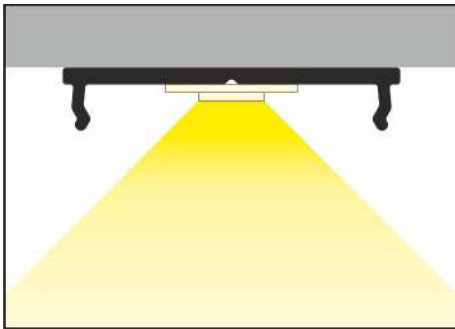

max 16 mm



special application
specjalny



mounting with screws
or adhesive tape
montaż na wkręty
albo taśmę dwustronną



INDEX = 1 pc, length 2000 mm
package = 10 pcs
INDEKS = 1 szt., długość 2000 mm
opakowanie = 10 szt.



white painted
biały malowany
C6020001



anodized
anodowany
C6020020



black anodized
czarny anodowany
C6020021



raw aluminium
surowe aluminium
C6020000

Available lengths / Dostępne długości
1000 mm, 2000 mm, 3000 mm, 4000 mm

OUTSTAIRS12 BC

BRASS PROFILE TO ILLUMINATE THE EDGE OF A STAIR STEPS

PROFIL MOSIĘŻNY DO OŚWIETLANIA KRAWĘDZI STOPNI

- decorative and lighting profile
- high resistance to weather conditions
- in high humidity conditions we recommend using IP65 LED strip
- maximum LED strip width: 12 mm
- profil dekoracyjno-oświetleniowy
- wysoka odporność na warunki atmosferyczne
- przy podwyższonej wilgotności stosować taśmę IP65
- maksymalna szerokość taśmy LED: 12 mm



SIMILAR IN THE OFFER / PODOBNE W OFERCIE



STEP10
C



FLOOR12
K/U



B slide cover
klosz B wsuwany

C click cover
klosz C klik

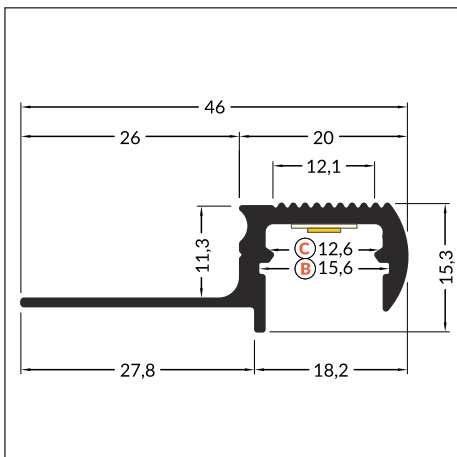
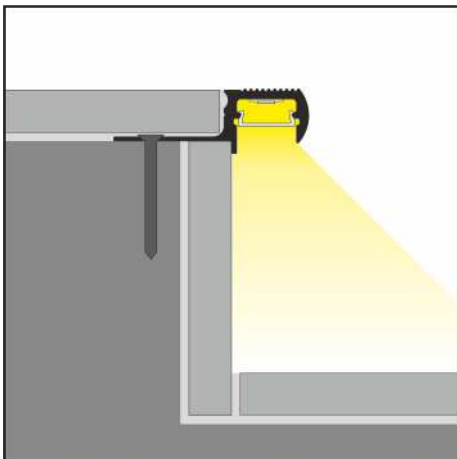
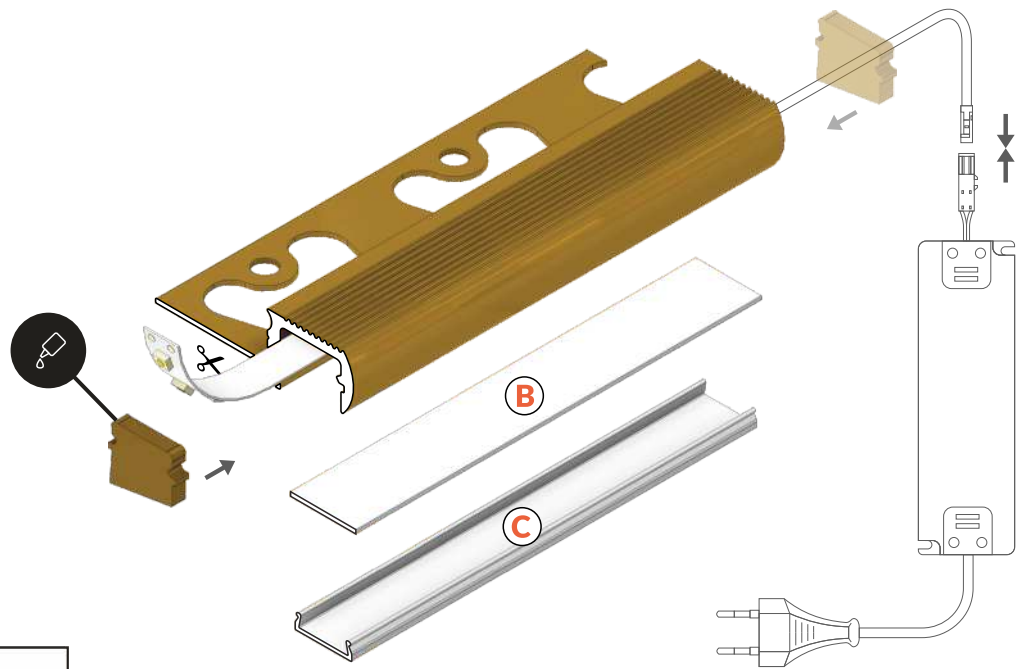

 max 12 mm

 special application
specjalny

INDEX = 1 pc, length 1600 mm
INDEKS = 1 szt., długość 1600 mm

 brass
mosiądz
B9020005s

Available lengths / Dostępne długości
1100 mm, 1600 mm





COVERS / KLOSZE

B slide cover
colours: transparent, frosted, white
material: PC, PP, PP

klosz B wsuwany
kolory: transparentny, szron, mleczny
materiał: PC, PP, PP



Note! Dimensions of the space to install LED source
Uwaga! Wymiary przestrzeni do zamontowania źródła LED

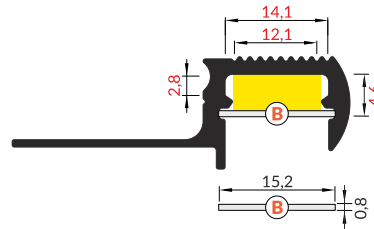

C click cover
colours: transparent, white
material: PMMA

klosz C klik
kolory: transparentny, mleczny
materiał: PMMA

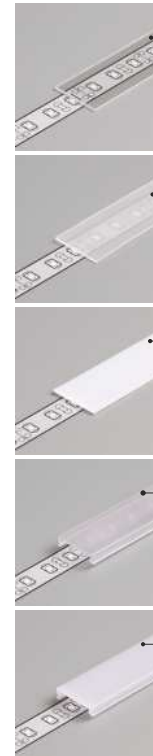
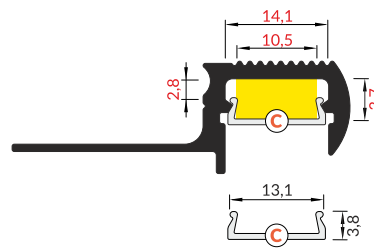

INDEX = 1 pc, length 2000 mm
package = 10 pcs
INDEKS = 1 szt., długość 2000 mm
opakowanie = 10 szt.

B transparent / B transparentny
76250016

B frosted / B szron
76250039

B white / B mleczny
76250038

C transparent / C transparentny
76330000

C white / C mleczny
76330038

ENDINGS / ZAŚLEPKI

OUTSTAIRS12 ending
colour: brass
material: brass

zaślepka OUTSTAIRS12
kolor: miedz
materiał: miedz

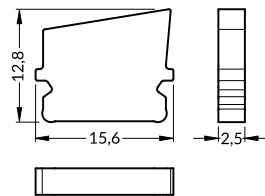

Endings mounted on assembly adhesive
Zaślepki mocowane na klej montażowy

INDEX = 1 set
INDEKS = 1 komplet

brass
miedz
B9990005



WALLE12 BCD

WALL-MOUNTED PROFILE

PROFIL DO MONTAŻU ŚCIENNEGO

- decorative and lighting profile
- mounted directly to a wall or ceiling
- 6 types of matching covers
- possibility of outdoor using (with D cover and waterproof LED strip)
- maximum LED strip width: 12 mm
- profil dekoracyjno-oświetleniowy
- montowany bezpośrednio do ściany lub sufitu
- 6 rodzajów pasujących kloszy
- możliwość zastosowania zewnętrznego (przy użyciu klosza D i taśmy wodoodpornej)
- maksymalna szerokość taśmy LED: 12 mm

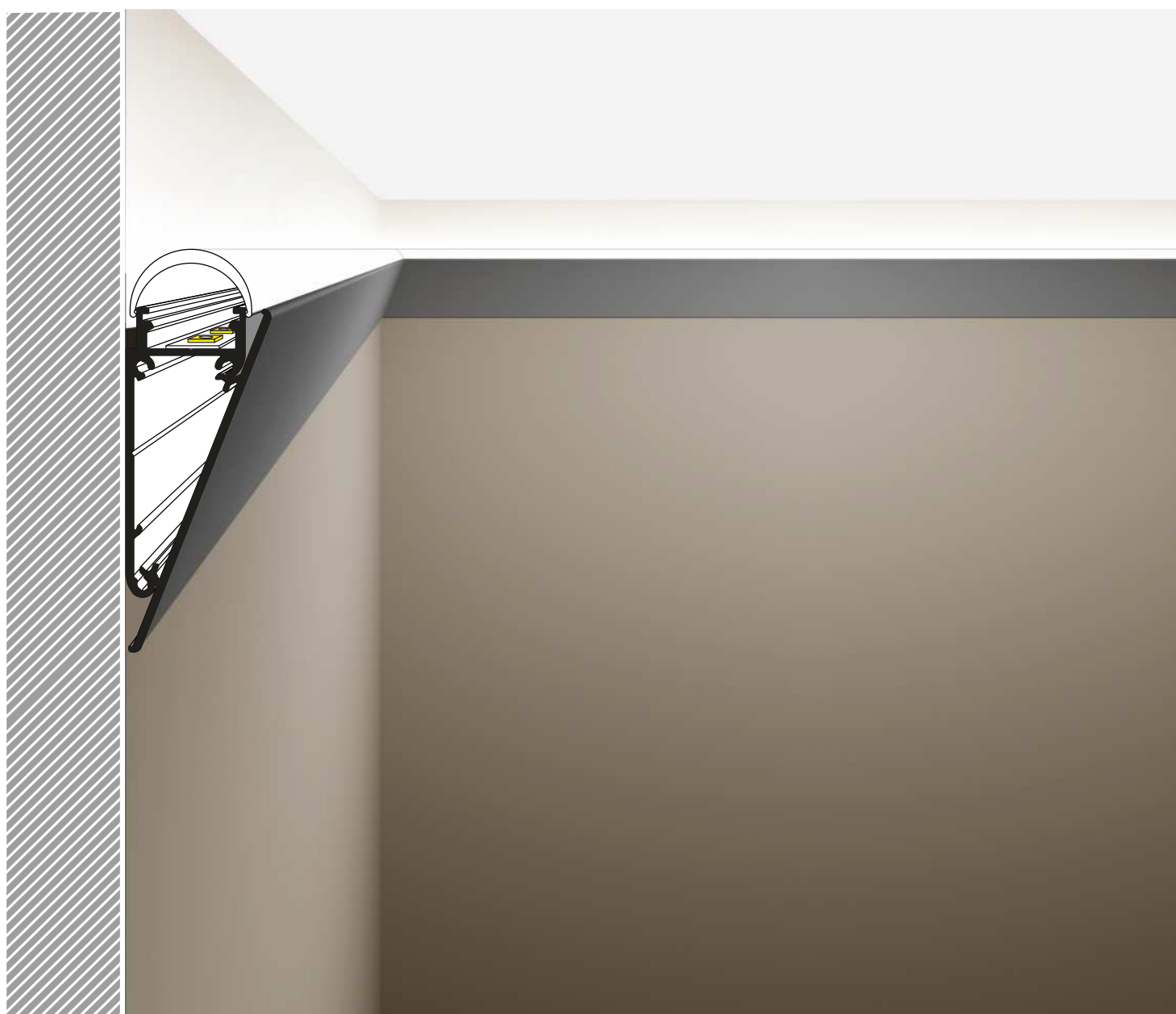

SIMILAR IN THE OFFER / PODOBNE W OFERCIE

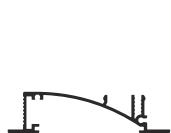

FLAT8
H/UX



BACK10
A/UX



AMBI12
C



FRAME14
BC/Q



B slide cover
klosz B wsuwany

C click cover
klosz C klik

D click cover
klosz D klik

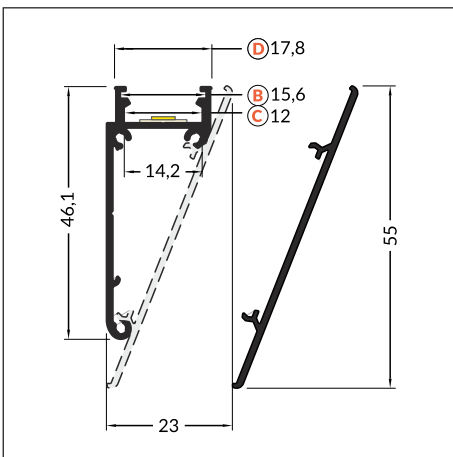
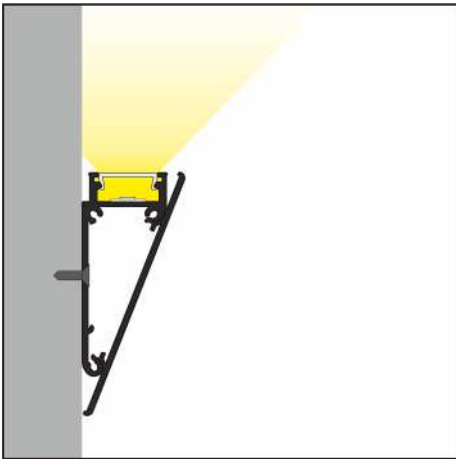
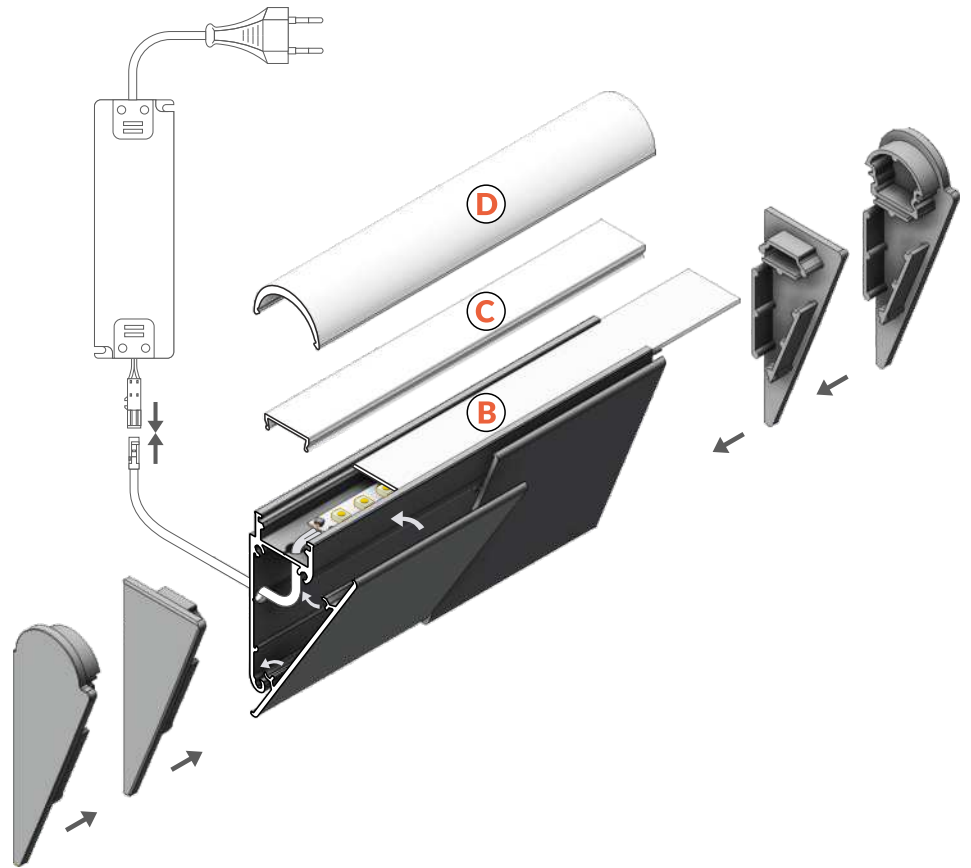

 max 12 mm

 special application
specjalny

INDEX = 1 pc, length 2000 mm
package = 10 pcs
INDEKS = 1 szt., długość 2000 mm
opakowanie = 10 szt.

 white painted
biały malowany
B8060001

 anodized
anodowany
B8020020

 raw aluminium
surowe aluminium
C6020000



Available lengths / Dostępne długości
1000 mm, 2000 mm, 3000 mm, 4000 mm



COVERS / KLOSZE

B slide cover
colours: transparent, frosted, white
material: PC, PP, PP

klosz **B** wsuwany
kolory: transparentny, szron, mleczny
materiał: PC, PP, PP

C click cover
colours: transparent, white
material: PMMA

klosz **C** klik
kolory: transparentny, mleczny
materiał: PMMA

D click cover
colour: transparent
material: PMMA

klosz **D** klik
kolor: transparentny
materiał: PMMA



Note!
Dimensions of the space
to install LED source
Uwaga!
Wymiary przestrzeni
do zamontowania
źródła LED

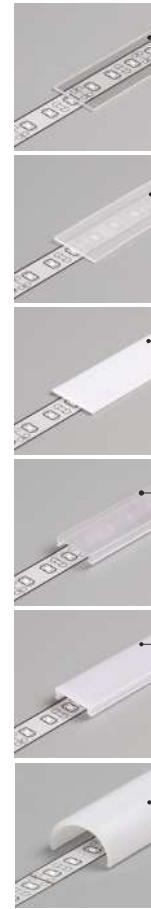
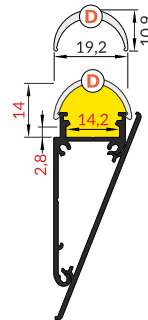
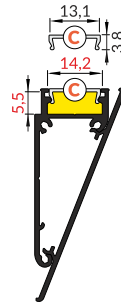
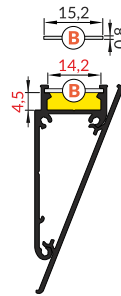

INDEX = 1 pc, length 2000 mm
package = 10 pcs
INDEKS = 1 szt., długość 2000 mm
opakowanie = 10 szt.

B transparent / B transparentny
76250016

B frosted / B szron
76250039

B white / B mleczny
76250038

C transparent / C transparentny
76330000

C white / C mleczny
76330038

D white / D mleczny
A1140038

ENDINGS / ZAŚLEPKI

WALLE12 ending
colours: white, silver, grey
material: ABS

zaślepka WALLE12
kolory: biały, srebrny, szary
materiał: ABS

WALLE12 D ending
colours: white, silver, grey
material: ABS

zaślepka WALLE12 D
kolory: biały, srebrny, szary
materiał: ABS

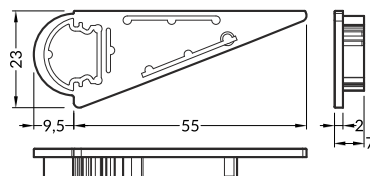
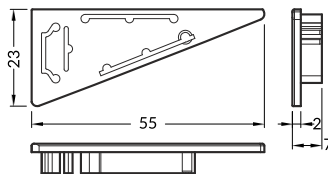

INDEX = 1 set
package of 10 sets = 20 pcs
INDEKS = 1 komplet
opakowanie zawiera 10 kpl = 20 szt

WALLE12 ending
zaślepka WALLE12

white biały B8900001
 silver srebro B8900040
 grey szary B8900022

WALLE12 D ending
zaślepka WALLE12 D

white biały B8890001
 silver srebro B8890040
 grey szary B8890022

COVER / OSŁONA

WALLE12 cover
colours: white, anodized
material: aluminium

osłona WALLE12
kolory: biały, anodowany
materiał: aluminium



INDEX = 1 pc, length 2000 mm
package = 10 pcs
INDEKS = 1 szt., długość 2000 mm
opakowanie = 10 szt.

white painted biały malowany B8080001
 anodized anodowany B8040020



CONNECTORS / ŁĄCZNIKI

WALLE12 connector 180 deg

colour: inox

material: stainless steel

łącznik WALLE12 180 st

kolor: inox

materiał: stal nierdzewna

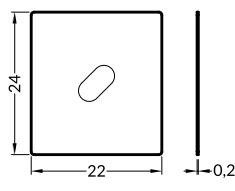

WALLE12 connector 90 deg

colours: white, anodized

material: aluminium

łącznik WALLE12 90 st

kolor: biały, anodowany

materiał: aluminium

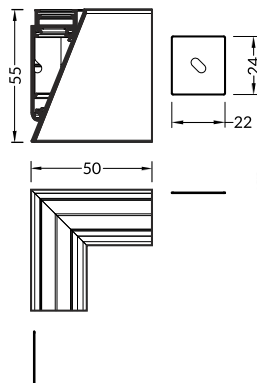

INDEX for 1 set
INDEKS dla 1 kompletu



inox
inox

B8950019



white painted
biały malowany

B8910001



anodized
anodowany

B8910020



FRAME14 BC/Q

ALUMINIUM LED PROFILE FOR PLASTERBOARD

ALUMINIOWY PROFIL LED DO PŁYT KARTONOWO-GIPSOWYCH

- decorative and lighting profile
- dedicated for plasterboards - decorative construction finish
- continuous line of light (when using LED strip 120 P/m and white cover)
- multiple arrangements through a variety of connectors
- maximum LED strip width: 14 mm
- profil dekoracyjno-oświetleniowy
- dedykowany do płyt kartonowo-gipsowych - dekoracyjne wykończenie konstrukcji
- ciągła linia światła (przy zastosowaniu taśmy 120 P/m i klosza mlecznego)
- wiele możliwości aranżacyjnych dzięki różnorodnym łącznikom
- maksymalna szerokość taśmy LED: 14 mm



SIMILAR IN THE OFFER / PODOBNE W OFERCIE



FLAT8
H/UX



DEEP10
BC/UX



WALLE12
CD



B slide cover
klosz B wsuwany

C click cover
klosz C klik

Q connector
łącznik Q

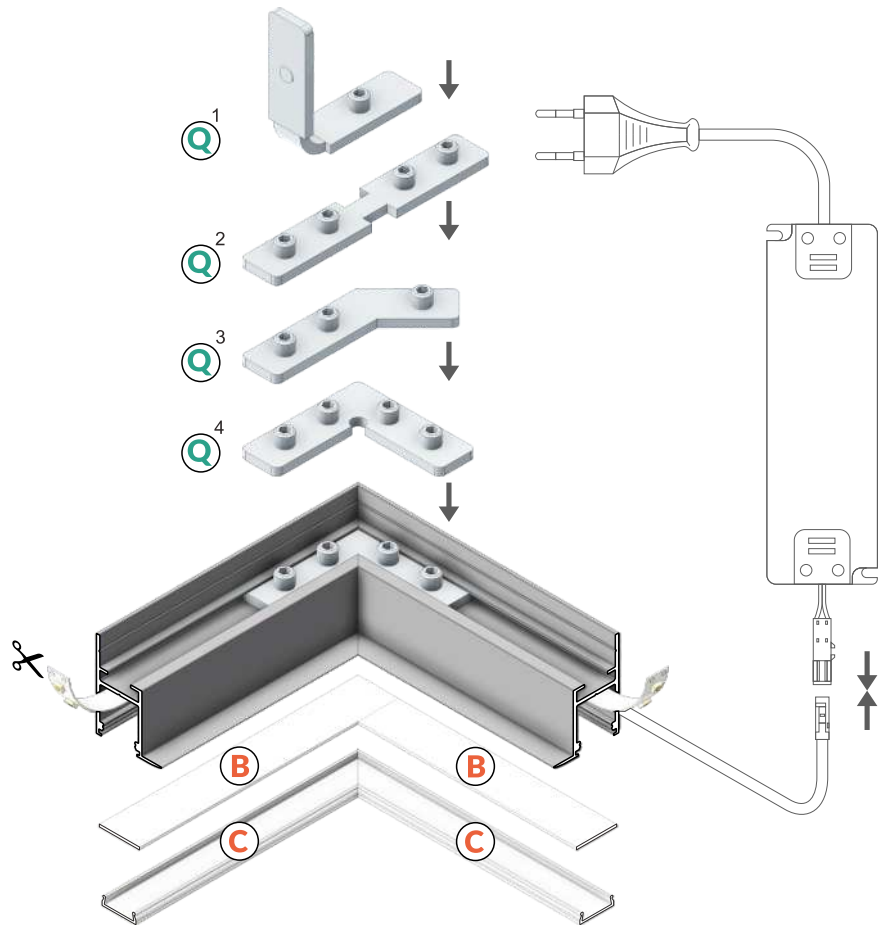
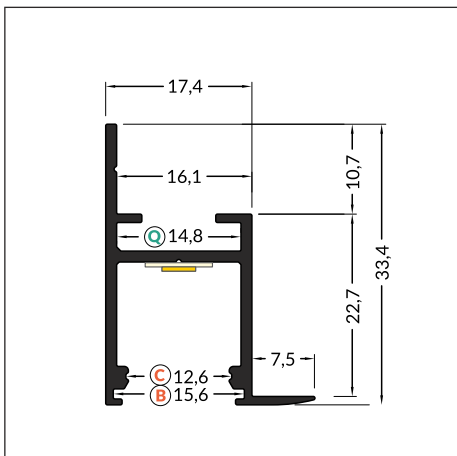
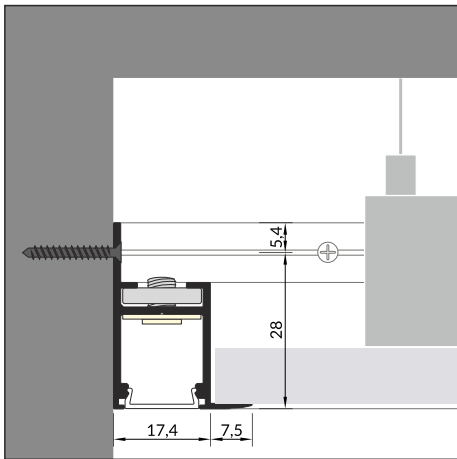
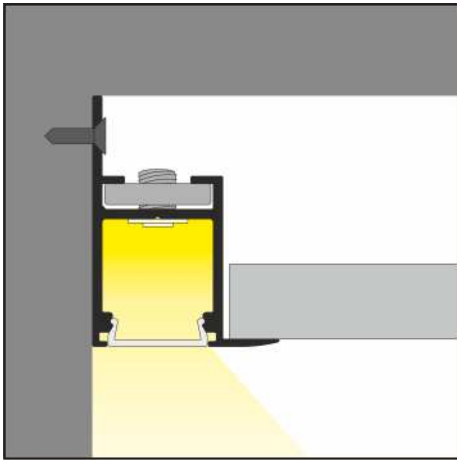

Please note! The profile isn't a construction profile.
Uwaga. Profil nie pełni funkcji konstrukcyjnej.

 max 14 mm

 special application
specjalny



INDEX = 1 pc, length 2000 mm
package = 10 pcs
INDEKS = 1 szt., długość 2000 mm
opakowanie = 10 szt.

 white painted
biały malowany
C3020001

 anodized
anodowany
C3020020

 raw aluminium
surowe aluminium
C3020000

Available lengths / Dostępne długości
1000 mm, 2000 mm, 3000 mm, 4000 mm



COVERS / KLOSZE

B slide cover
colours: transparent, frosted, white
material: PC, PP, PP

klosz **B** wsuwany
kolory: transparentny, szron, mleczny
materiał: PC, PP, PP



Note!
Dimensions of the space
to install LED source
Uwaga!
Wymiary przestrzeni
do zamontowania
źródła LED

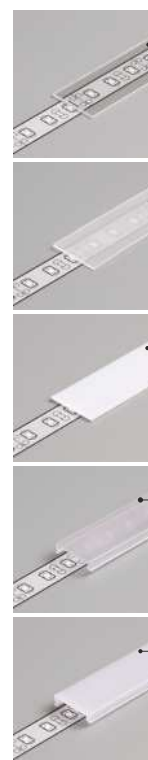
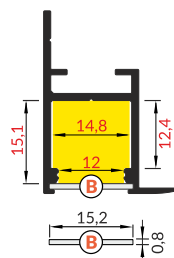

INDEX = 1 pc, length 2000 mm
package = 10 pcs
INDEKS = 1 szt., długość 2000 mm
opakowanie = 10 szt.

B transparent / B transparentny
76250016

B frosted / B szron
76250039

B white / B mleczny
76250038

C transparent / C transparentny
76330000

C white / C mleczny
76330038

C click cover
colours: transparent, white
material: PMMA

klosz **C** klik
kolory: transparentny, mleczny
materiał: PMMA

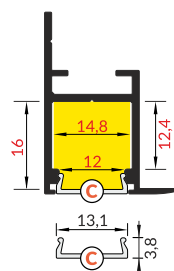

CONNECTORS / ŁĄCZNIKI

Q connector 180 deg / 135 deg / 90 deg
material: zinc coated

łącznik **Q** 180 st / 135 st / 90 st
materiał: stal ocynkowana

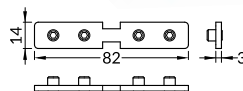

INDEX = 1 pc
INDEKS = 1 szt

Q 180 deg connector
łącznik **Q** 180 st
C3990030

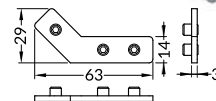

Q 135 deg connector
łącznik **Q** 135 st
C3980030

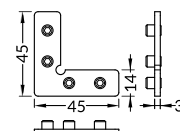

Q 90 deg connector
łącznik **Q** 90 st
C3970030

Q 90 deg bent connector
material: zinc coated

łącznik **Q** 90 st gięty
materiał: stal ocynkowana

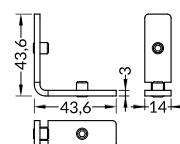

Q 90 deg bent connector
łącznik **Q** 90 st gięty
C3960030



OVAL20 BC

A DOUBLE-FUNCTION BAR FOR WARDROBES

DWUFUNKCYJNY DRAŻEK DO SZAF GARDEROBIANYCH

- decorative and lighting profile
 - a bar for hanging garments and illuminating the wardrobe
 - 3 mounting options: side-to-side, as an extension arm from a side, as an extension arm from the top
 - two LED strip installation depths to choose from
 - maximum LED strip width: 20 mm
-
- profil oświetleniowo-dekoracyjny
 - drążek do wieszania ubrań i oświetlania szafy
 - 3 opcje montażu: od ścianki do ścianki, jako wysięgnik ze ściany, jako wysięgnik z sufitu
 - do wyboru dwie głębokości osadzenia taśmy LED
 - maksymalna szerokość taśmy LED: 20 mm

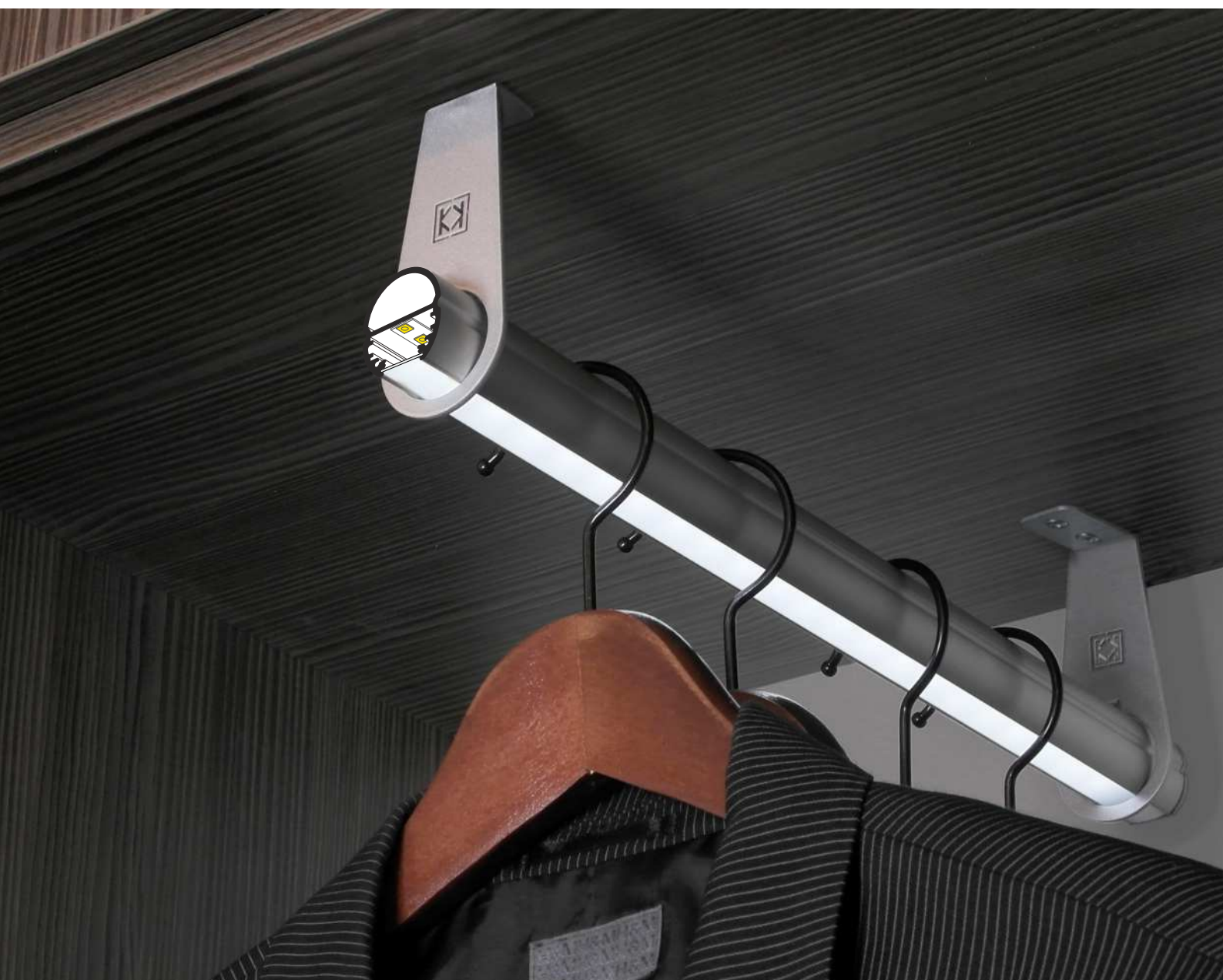

SIMILAR IN THE OFFER / PODOBNE W OFERCIE



B slide cover
klosz B wsuwany

C click cover
klosz C klik

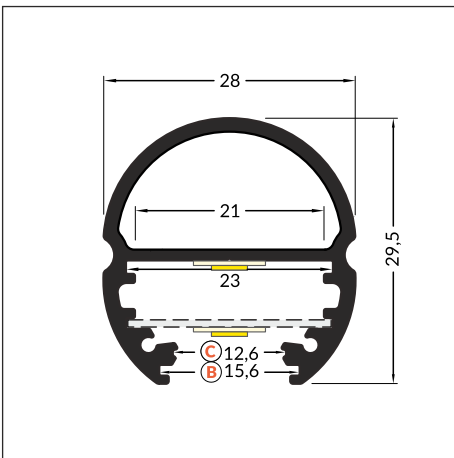
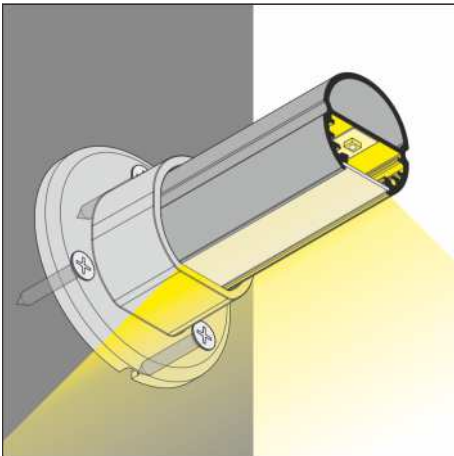
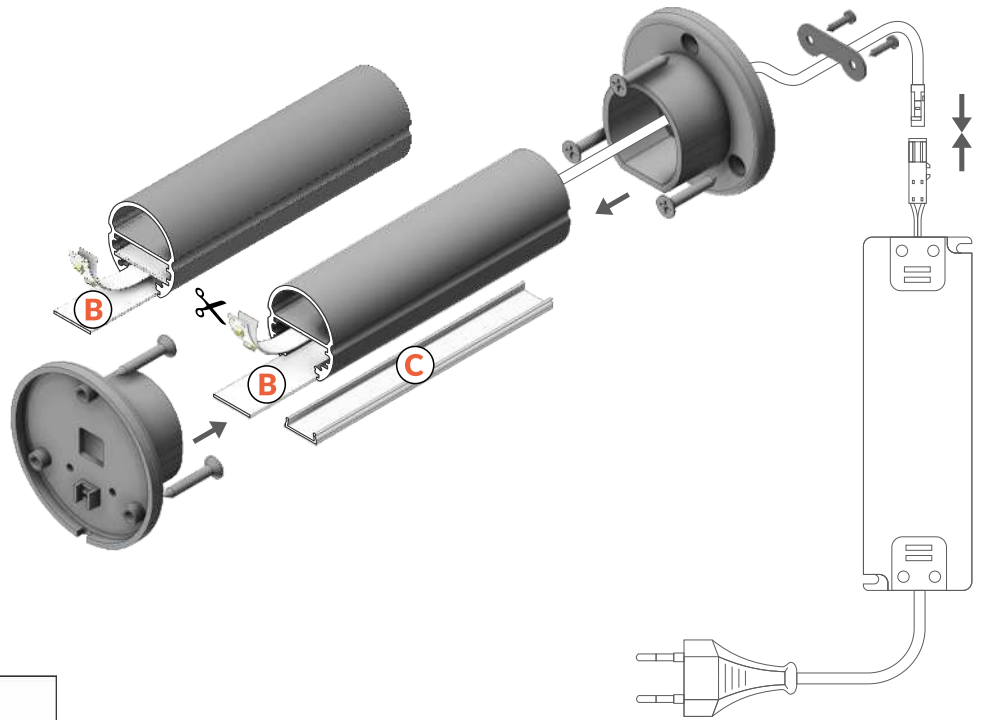

 max 20 mm

 special application
specjalny

INDEX = 1 pc, length 2000 mm
package = 10 pcs
INDEKS = 1 szt., długość 2000 mm
opakowanie = 10 szt.

 anodized
anodowany
92030020

Available lengths / Dostępne długości
1000 mm, 2000 mm, 3000 mm, 4000 mm



COVERS / KLOSZE

B slide cover

colours: transparent, frosted, white
material: PC, PP, PP

klosz B wsuwany
kolory: transparentny, szron, mleczny
materiał: PC, PP, PP



Note! Dimensions of the space to install LED source
Uwaga! Wymiary przestrzeni do zamontowania źródła LED

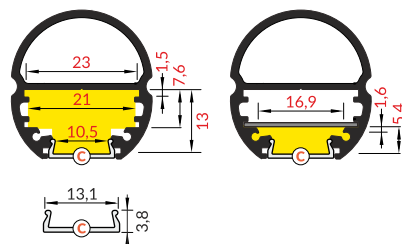
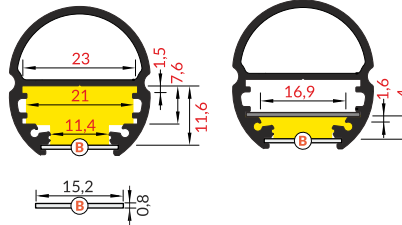

INDEX = 1 pc, length 2000 mm
package = 10 pcs
INDEKS = 1 szt., długość 2000 mm
opakowanie = 10 szt.

B transparent / B transparentny
76250016

B frosted / B szron
76250039

B white / B mleczny
76250038

C transparent / C transparentny
76330000

C white / C mleczny
76330038

MOUNTINGS / MOCOWANIA

OVAL20 side holder

colours: silver, grey
material: ABS

uchwyt OVAL20 boczny
kolory: srebrny, szary
materiał: ABS

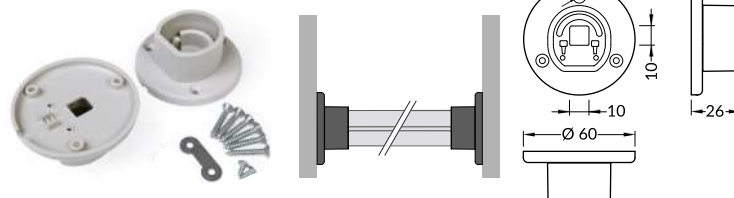

INDEX = 1 set
INDEKS = 1 komplet

OVAL20 side holder
uchwyt OVAL20 boczny

silver srebrny 92040040

grey szary 92040022

OVAL20 single extension arm

colour: silver
material: ABS, steel, aluminium

wysięgnik OVAL20 pojedynczy
kolor: srebrny
materiał: ABS, stal, aluminium

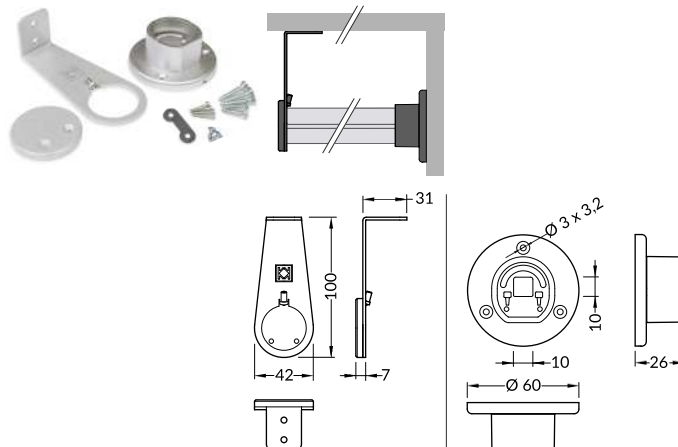

single extension arm
wysięgnik pojedynczy

silver srebrny 92980040

OVAL20 double extension arm

colour: silver
material: ABS, steel, aluminium

wysięgnik OVAL20 podwójny
kolor: srebrny
materiał: ABS, stal, aluminium

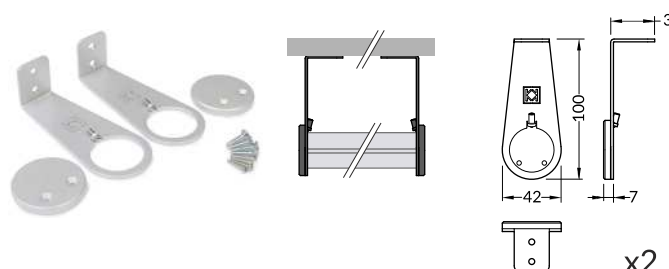

double extension arm
wysięgnik podwójny

silver srebrny 92990040



MOUNTINGS / MOCOWANIA

OVAL20 simple holder
material: zinc coated steel

uchwyt OVAL20 prosty
materiał: stal ocynkowana

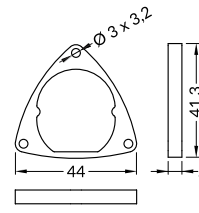
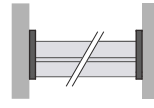

INDEX = 1 set
INDEKS = 1 komplet

OVAL20 simple holder
uchwyt OVAL20 prosty

 zinc coated steel
stal ocynkowana
92070030

LED MOUNTING / MOCOWANIE LED

OVAL20 LED mounting
material: aluminium

mocowanie LED OVAL20
materiał: aluminium

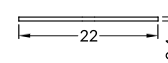

INDEX for 2000 mm length
INDEKS dla długości 2000 mm

 raw aluminium
surowe aluminium
92100000





**GLASS APPLICATION
DO SZKŁA**

2018

**LED profiles
profile LED**

TWIN8

A TWO-WAY EDGE PROFILE FOR GLASS SHELVES

DWUKIERUNKOWY PROFIL KRAWĘDZIOWY DO SZKLANYCH PÓŁEK

- decorative and lighting profile
- mounted on the glass or shelf rear edge
- 2 lighting directions: up and down
- illuminating the rear side of a display case
- additionally illumination of the glass edge with the TWIN8 PLUS profile
- fits the 8 mm thick glass panel
- when using on a thinner glass, consider additional adhesive tape
- note: the profile is not a construction element
- maximum LED strip width: 8 mm
- profil dekoracyjno-oświetleniowy
- montaż do tylnej krawędzi szyby, półki
- 2 kierunki świecenia: góra i dół
- oświetla wewnętrzną ścianę witryny
- dodatkowo podświetlenie krawędzi szyby w wersji TWIN8 PLUS
- do szyby o grubości 8 mm
- możliwość zastosowania do cieńszej szyby - należy przewidzieć dodatkowe klejenie taśmą
- uwaga: profil nie jest elementem konstrukcyjnym
- maksymalna szerokość taśmy LED: 8 mm

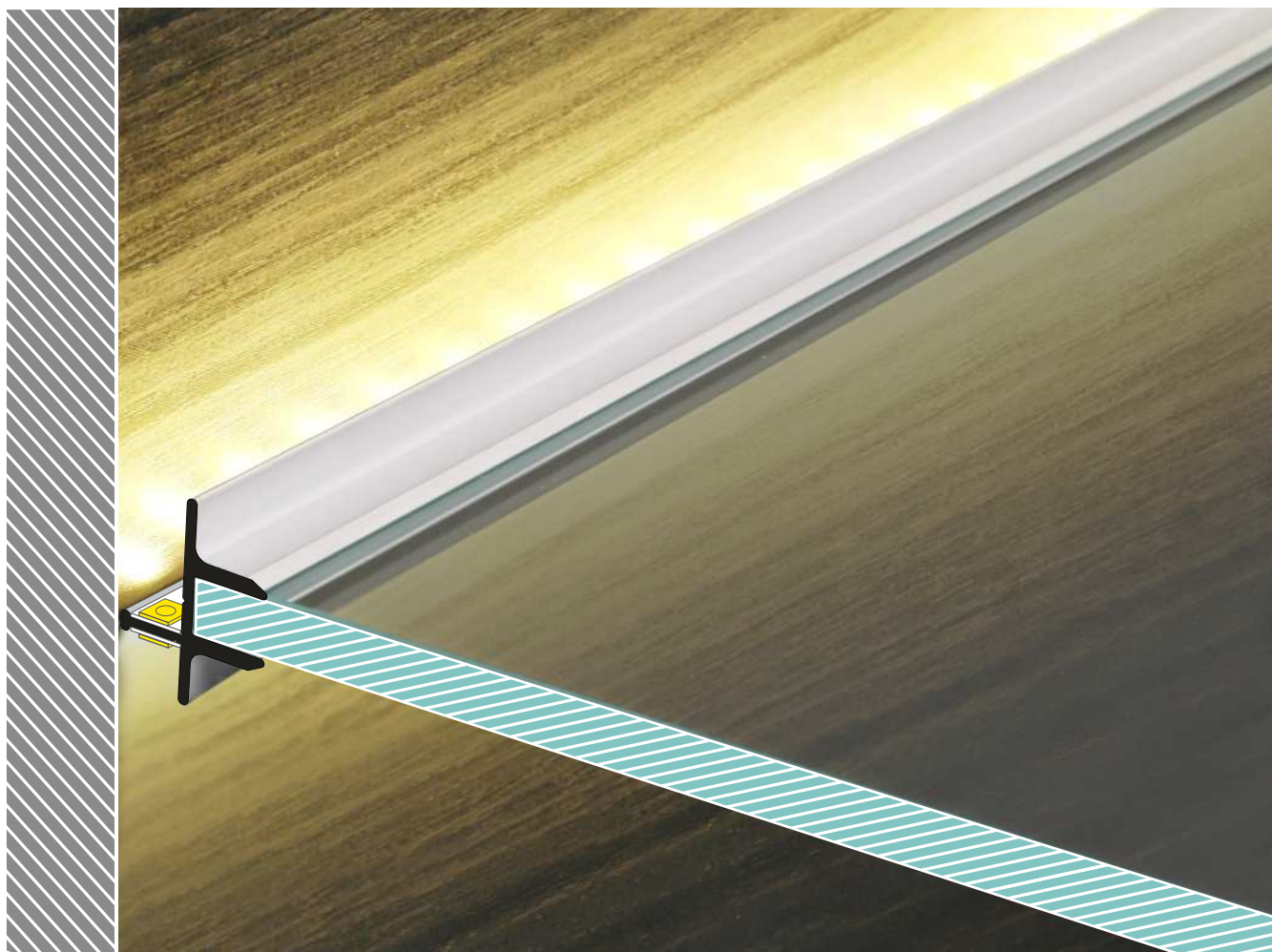

SIMILAR IN THE OFFER / PODOBNE W OFERCIE



BACK10
A/UX



EDGE10
BC



MIKRO10



MIKRO-LINE12



CABI12
E

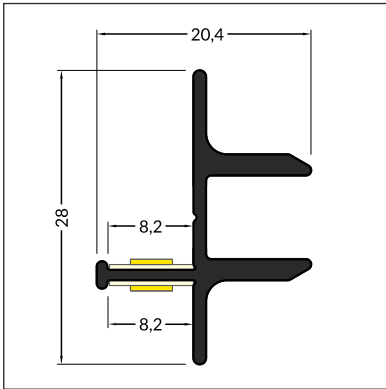

max 8 mm



glass application
do szkła

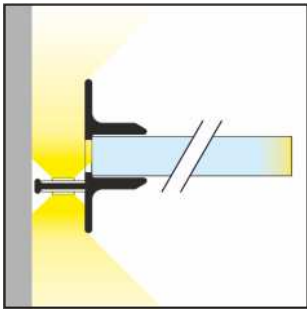
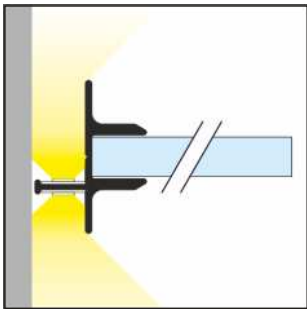
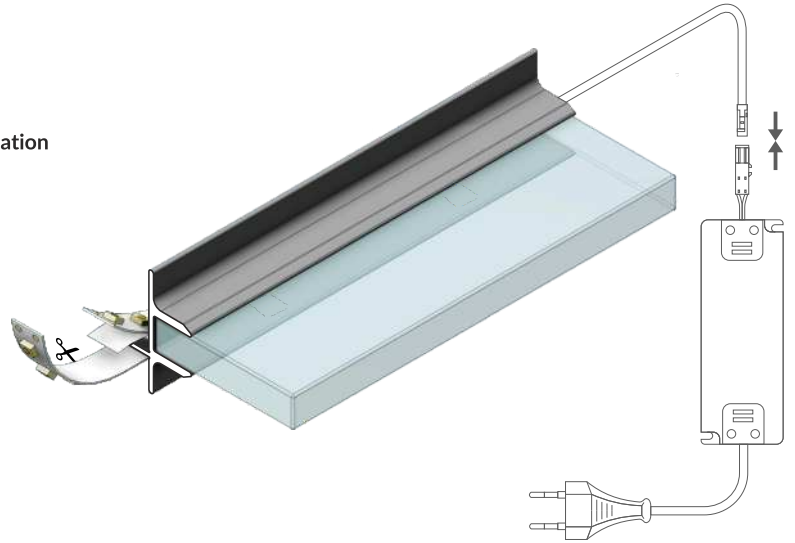

INDEX = 1 pc, length 2000 mm
package = 10 pcs
INDEKS = 1 szt., długość 2000 mm
opakowanie = 10 szt.

TWIN8
raw aluminium
surowe aluminium
82150000

TWIN8 PLUS
raw aluminium
surowe aluminium
82160000

Available lengths / Dostępne długości
1000 mm, 2000 mm, 3000 mm, 4000 mm

THERMAL TAPE / TAŚMA TERMALNA

thermal tape 45 x 10 mm
self adhesive, double-sided

taśma termalna 45 x 10 mm
samoprzylepna, dwustronna

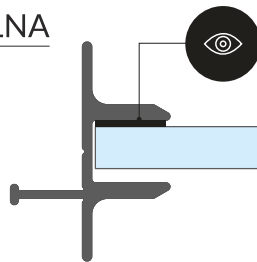

INDEX = 1 pc
INDEKS = 1 szt.

53820000

LED profiles • glass application • TWIN8
profile LED • do szyb • TWIN8



MIKRO10

A SMALL EDGE PROFILE FOR GLASS PANELS

MAŁY PROFIL KRAWĘDZIOWY DO SZYB

- to illuminate the edge or engraving on the glass panel surface
 - to be used for furniture (display cases) or advertising
 - discreet form
 - fits the 6 mm thick glass panel
 - note: the profile is not a construction element
 - maximum LED strip width: 10 mm
-
- do podświetlania krawędzi lub graweru na płaszczyźnie szyby
 - głównie do zastosowania meblowego (gabloty) lub reklamowego
 - dyskretna forma
 - do szyb o grubości 6 mm
 - uwaga: profil nie jest elementem konstrukcyjnym
 - maksymalna szerokość taśmy LED: 10 mm



SIMILAR IN THE OFFER / PODOBNE W OFERCIE



TWIN8



EDGE10
BC



MIKRO-LINE12



CABI12
E

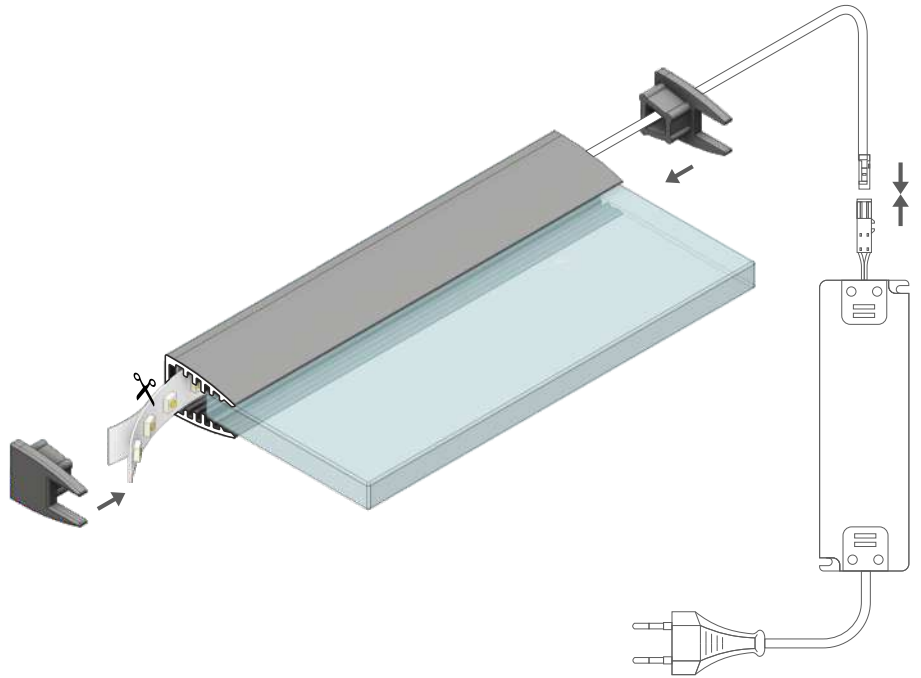
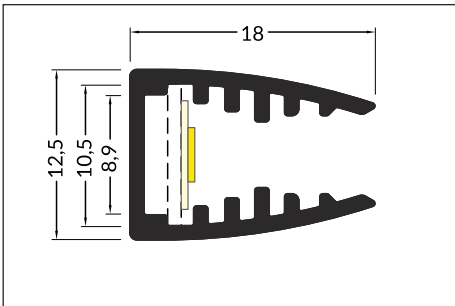
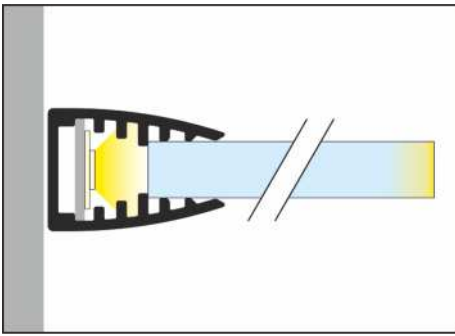

max 10 mm



glass application
do szkła



INDEX = 1 pc, length 2000 mm
package = 10 pcs
INDEKS = 1 szt., długość 2000 mm
opakowanie = 10 szt.

anodized
anodowany 68540020

Available lengths / Dostępne długości
1000 mm, 2000 mm, 3000 mm, 4000 mm

ENDINGS / ZAŚLEPKI

MIKRO10 ending
colours: silver, grey, transparent
material: ABS, ABS, PC
zaślepka MIKRO10
kolory: srebrny, szary, transparentny
materiał: ABS, ABS, PC

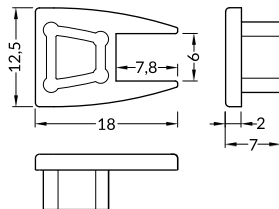

INDEX = 1 set
package of 10 sets = 20 pcs
INDEKS = 1 komplet, opakowanie
zawiera 10 kompletów = 20 szt.

silver
srebrne 68550040

grey
szare 68550022

transparent
transparentne 68550000

LED MOUNTING / MOCOWANIE LED

MIKRO10 LED mounting
material: HIPS
mocowanie LED MIKRO10
materiał: HIPS

INDEX = 1 pc, length 2000 mm
package = 10 pcs
INDEKS = 1 szt., długość 2000 mm
opakowanie = 10 szt.

68640000

Available lengths / Dostępne długości
1000 mm, 2000 mm



EDGE10 BC

FINISHING EDGES AND LIGHTING OF DISPLAY WINDOWS

WYKOŃCZENIE KRAWĘDZI I OŚWIETLENIE EKSPOZYCJI

- the product for finishing and strengthening display window edges to a thickness up to 8 mm
- suitable for decorative 'framing' of the display window
- light is emitted at an angle - it does not cause glare
- top or bottom illumination
- easy installation - a double-sided tape not visible to customers
- when using on a thinner glass, consider additional wedging or adhesive tape
- maximum LED strip width: 10 mm
- wykańcza i wzmacnia krawędź szyby o grubości do 8 mm
- umożliwia budowanie ramki okalającej szybę
- światło skierowane pod kątem - nie powoduje ośnienia
- oświetlanie od góry lub od dołu
- łatwy montaż poprzez wklejenie - niewidoczne mocowanie taśmą dwustronną
- przy zastosowaniu do cieńszej szyby należy przewidzieć dodatkowe klinowanie lub klejenie taśmą
- maksymalna szerokość taśmy LED: 10 mm

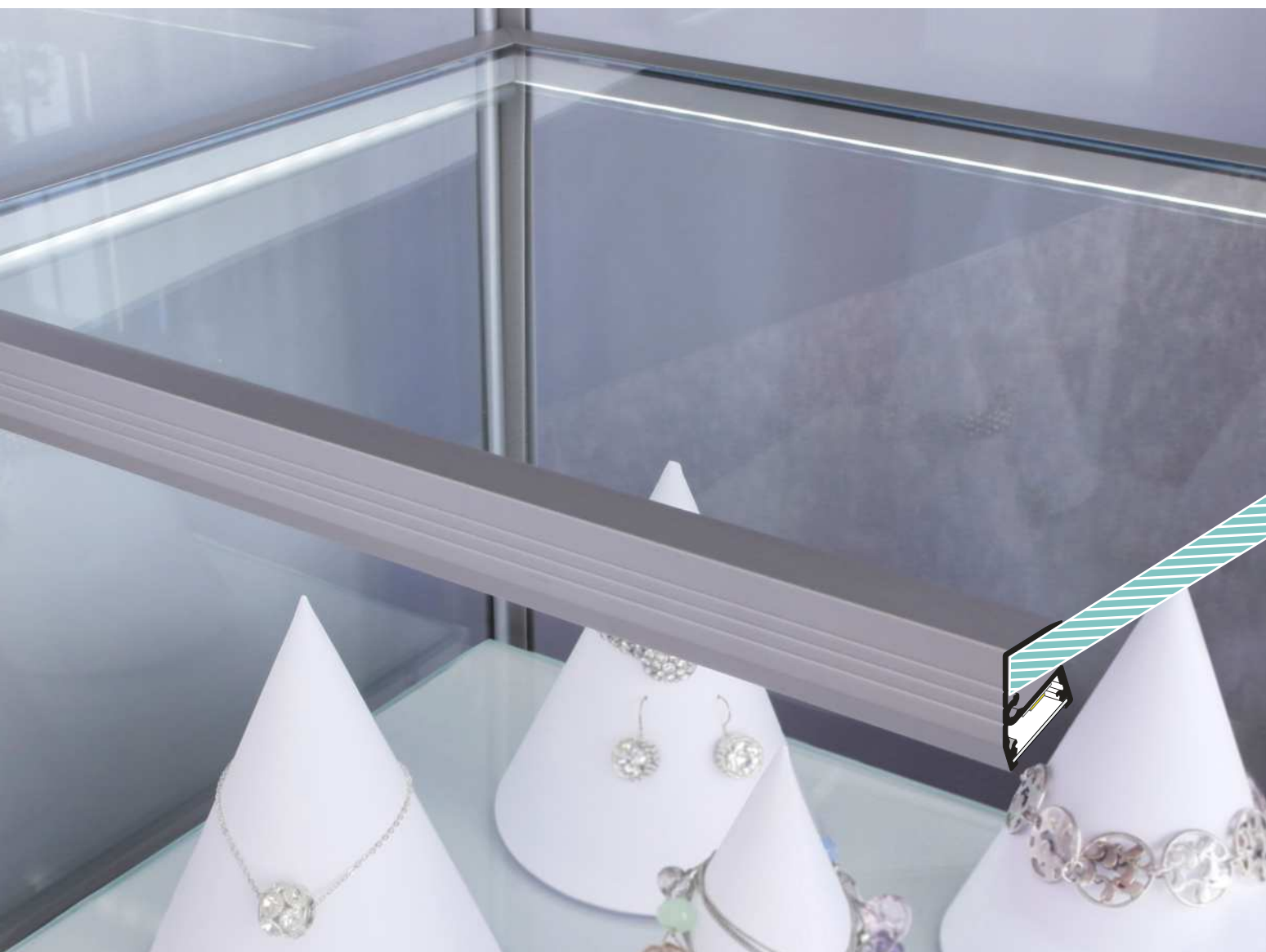

SIMILAR IN THE OFFER / PODOBNE W OFERCIE



TWIN8



MIKRO10



MIKRO-LINE12

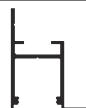

FRAME14
BC/Q



CABI12
E



B slide cover
klosz B wsuwany

C click cover
klosz C klik

C lens cover
klosz C soczewka

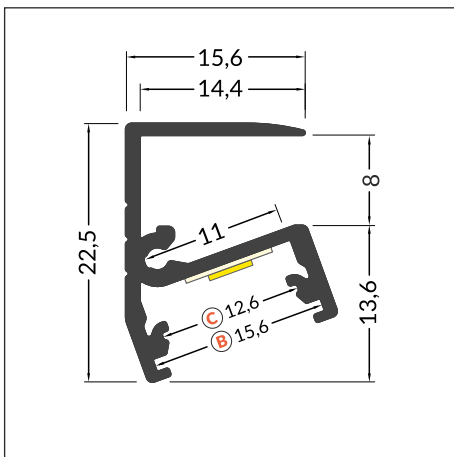
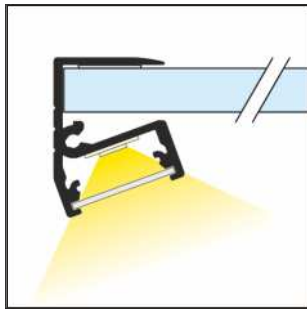
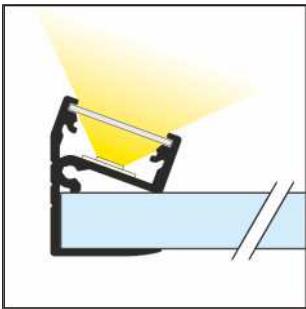
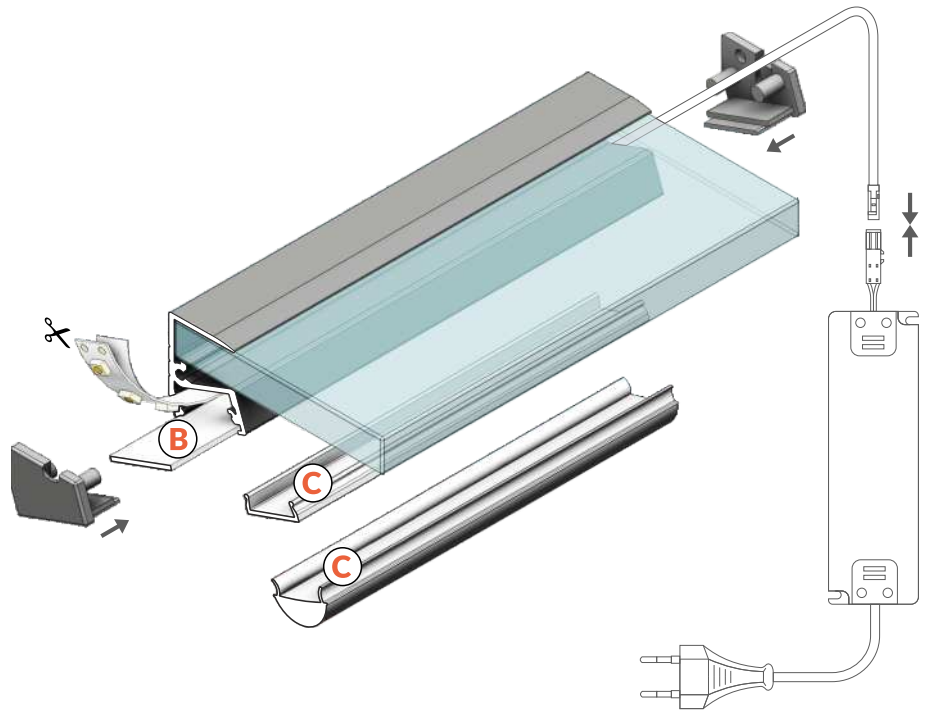

 max 10 mm

 glass application
do szkła

INDEX = 1 pc, length 2000 mm
package = 10 pcs
INDEKS = 1 szt., długość 2000 mm
opakowanie = 10 szt.

 white painted
biały malowany
A9020001

 anodized
anodowany
A9020020

 black anodized
czarny anodowany
A9020021

 raw aluminium
surowe aluminium
A9020000

Available lengths / Dostępne długości
1000 mm, 2000 mm, 3000 mm, 4000 mm



COVERS / KLOSZE

B slide cover
colours: transparent, frosted, white
material: PC, PP, PP

klosz B wsuwany
kolory: transparentny, szron, mleczny
materiał: PC, PP, PP

Note! Dimensions of the space to install LED source
Uwaga! Wymiary przestrzeni do zamontowania źródła LED

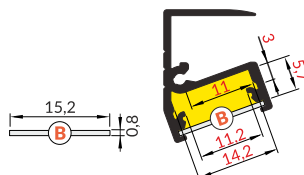

B transparent / B transparentny
76250016

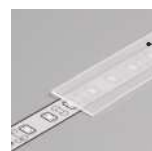

B frosted / B szron
76250039



B white / B mleczny
76250038

C click cover
colours: transparent, white
material: PMMA

klosz C klik
kolory: transparentny, mleczny
materiał: PMMA

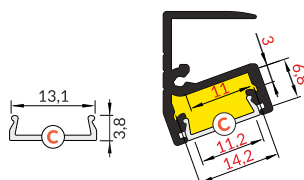

C transparent / C transparentny
76330000

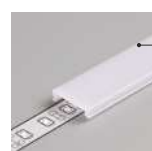

C white / C mleczny
76330038

C lens click cover
colour: transparent
material: PC

klosz C klik soczewka
kolor: transparentny
materiał: PC

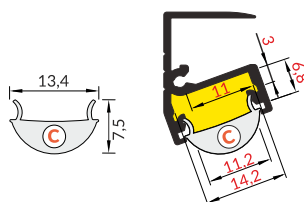

C lens / C soczewka
76300000



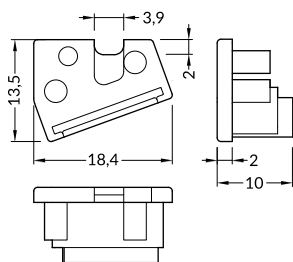

ENDINGS / ZAŚLEPKI

EDGE10 ending with hole
colours: white, silver, black, grey
material: ABS

zaślepka EDGE10 z otworem
kolory: biały, srebrny, czarny, szary
materiał: ABS



INDEX = 1 set,
package of 10 sets = 20 pcs
INDEKS = 1 komplet, opakowanie
zawiera 10 kompletów = 20 szt.

-  white / biały A9960001
-  silver / srebrny A9960040
-  black / czarne A9960002
-  grey / szary A9960022

THERMAL TAPE / TAŚMA TERMALNA

thermal tape 45 x 10 mm
self adhesive, double-sided

taśma termalna 45 x 10 mm
samoprzylepna, dwustronna

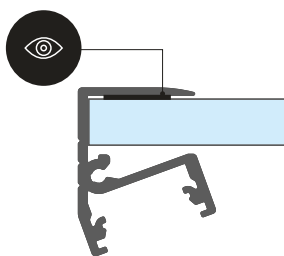

INDEX = 1 pc
INDEKS = 1 szt.

53820000



Depending on the installation method, EDGE10 profile may illuminate the display area from the top or from below.

W zależności od sposobu montażu profil EDGE10 daje możliwość oświetlenia ekspozycji od góry lub od dołu.



MIKRO-LINE12 J

EDGE PROFILE FOR GLASS PANELS

PROFIL KRAWĘDZIOWY DO SZYB

- decorative and lighting profile
- illuminates the edge or engraving on the glass panel surface
- for furniture and advertisement use mainly
- fits the 8 mm glass panels
- note: the profile is not a construction element
- maximum LED strip width: 12 mm
- profil dekoracyjno-oświetleniowy
- oświetla krawędź lub grawer na płaszczyźnie szyby
- głównie do użytku meblowego i reklamowego
- pasuje do szyb 8 mm
- uwaga: profil nie jest elementem konstrukcyjnym
- maksymalna szerokość taśmy LED: 12 mm

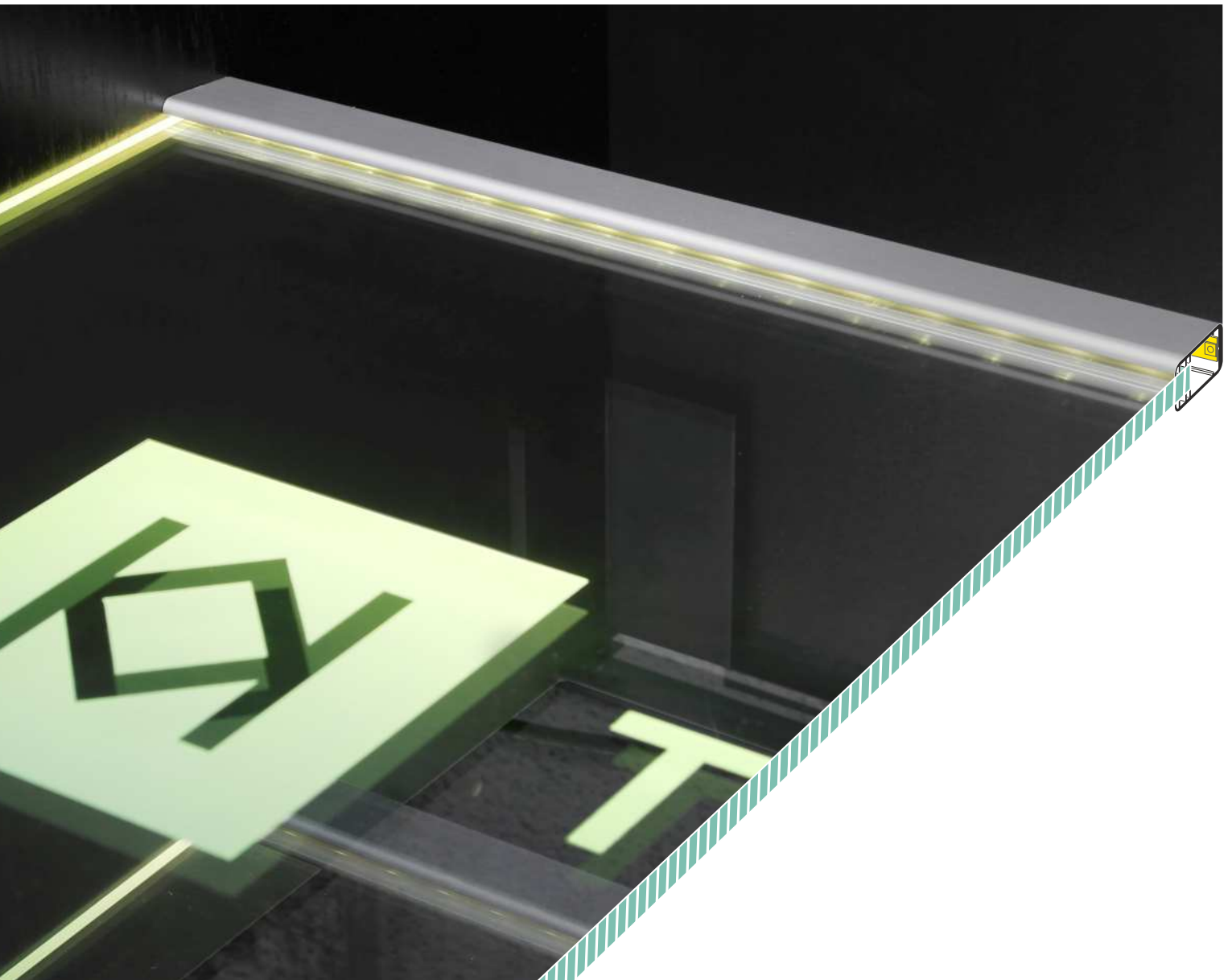

SIMILAR IN THE OFFER / PODOBNE W OFERCIE



TWIN8



EDGE10
BC



MIKRO10



CABI12
E

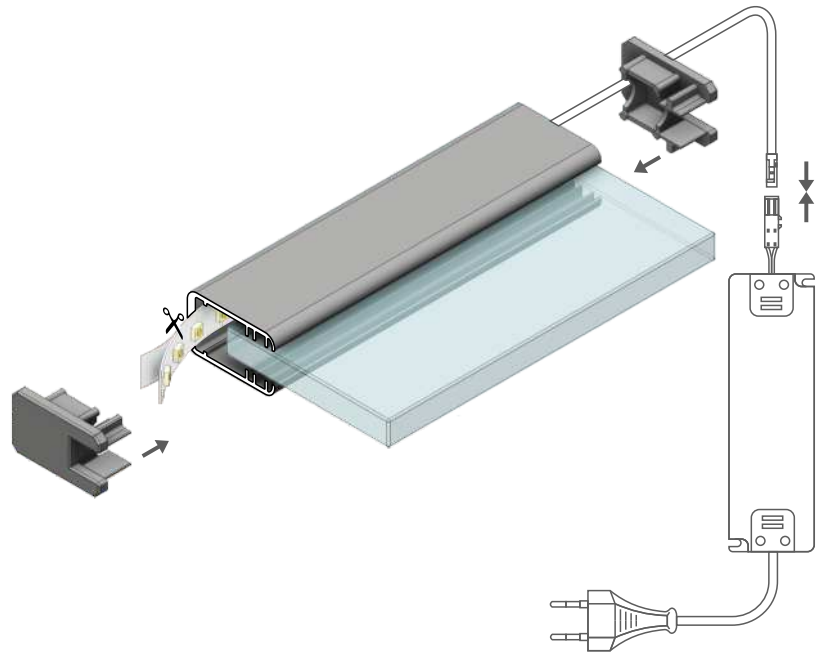
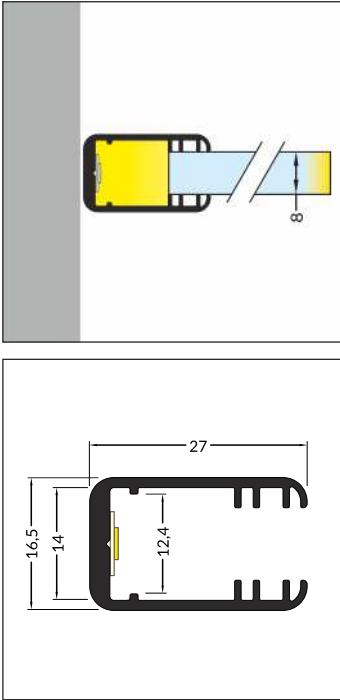

max 12 mm



glass application
do szkła



available in stock
dostępny na magazynie



INDEX = 1 pc, length 2000 mm
package = 10 pcs
INDEKS = 1 szt., długość 2000 mm
opakowanie = 10 szt.

anodized
anodowany
70280020

raw aluminium
surowe aluminium
70280000

Available lengths / Dostępne długości
1000 mm, 2000 mm, 3000 mm, 4000 mm

ENDINGS / ZAŚLEPKI

MIKRO-LINE12 ending
colours: silver, grey, transparent
material: ABS, ABS, PC
zaślepka MIKRO-LINE12
kolory: srebrny, szary, transparentny
materiał: ABS, ABS, PC

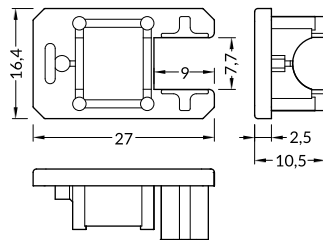

INDEX = 1 set
package of 10 sets = 20 pcs
INDEKS = 1 komplet, opakowanie
zawiera 10 kompletów = 20 szt.

silver
srebrne 70290040

grey
szare 70290022

transparent
transparentne 70290000



Note! Dimensions of the space to install LED source
Uwaga! Wymiary przestrzeni do zamontowania źródła LED

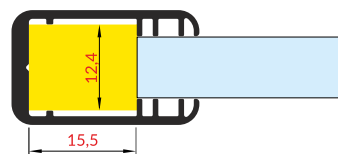

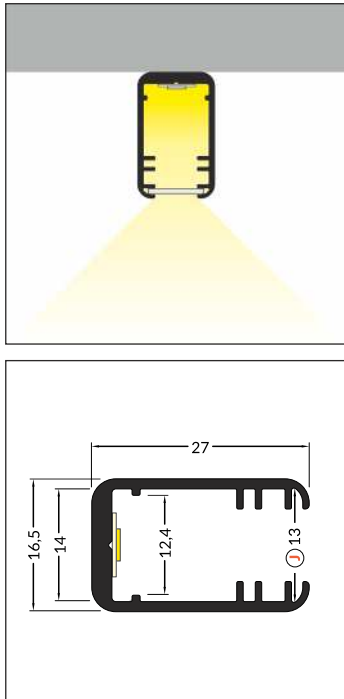

J slide cover
klosz **J** wsuwany

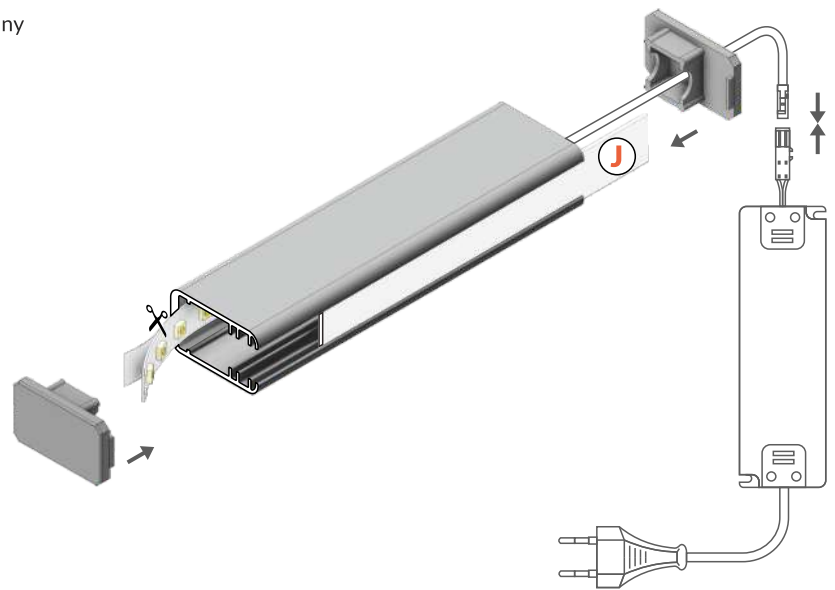

max 12 mm

special application
specjalny

available in stock
dostępny na magazynie



INDEX = 1 pc, length 2000 mm
package = 10 pcs
INDEKS = 1 szt., długość 2000 mm
opakowanie = 10 szt.

anodized
anodowany
70280020

raw aluminium
surowe aluminium
70280000

Available lengths / Dostępne długości
1000 mm, 2000 mm, 3000 mm, 4000 mm

ENDINGS / ZAŚLEPKI

MIKRO-LINE12 LINIA ending
colours: silver, grey, transparent
material: ABS, ABS, PC
zaślepka MIKRO-LINE12 LINIA
kolory: srebrny, szary, transparentny
material: ABS, ABS, PC

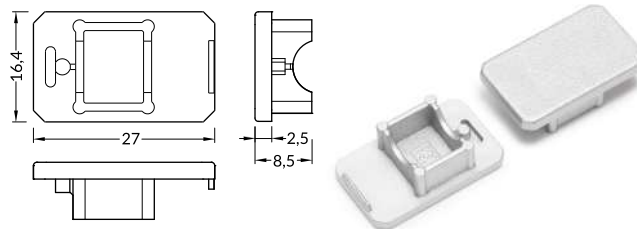

INDEX = 1 set
package of 10 sets = 20 pcs
INDEKS = 1 komplet, opakowanie
zawiera 10 kompletów = 20 szt.

silver
srebrne **70300040**

grey
szare **70300022**

transparent
transparentne **70300000**

COVERS / KLOSZE

J slide cover
colours: transparent, frosted, white
material: PC, PP, PP

klosz **J** wsuwany
kolory: transparentny, szron, mleczny
material: PC, PP, PP

Note! Dimensions of the space
to install LED source
Uwaga! Wymiary przestrzeni
do zamontowania źródła LED

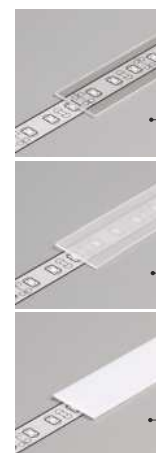
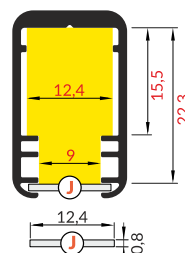

INDEX = 1 pc, length 2000 mm
package = 10 pcs
INDEKS = 1 szt., długość 2000 mm
opakowanie = 10 szt.

transparent / J transparentny
70330016

frosted / J szron
70330039

white / J mleczny
70330038

**PROFILE APPLICATION:
ZASTOSOWANIE PROFILU:**

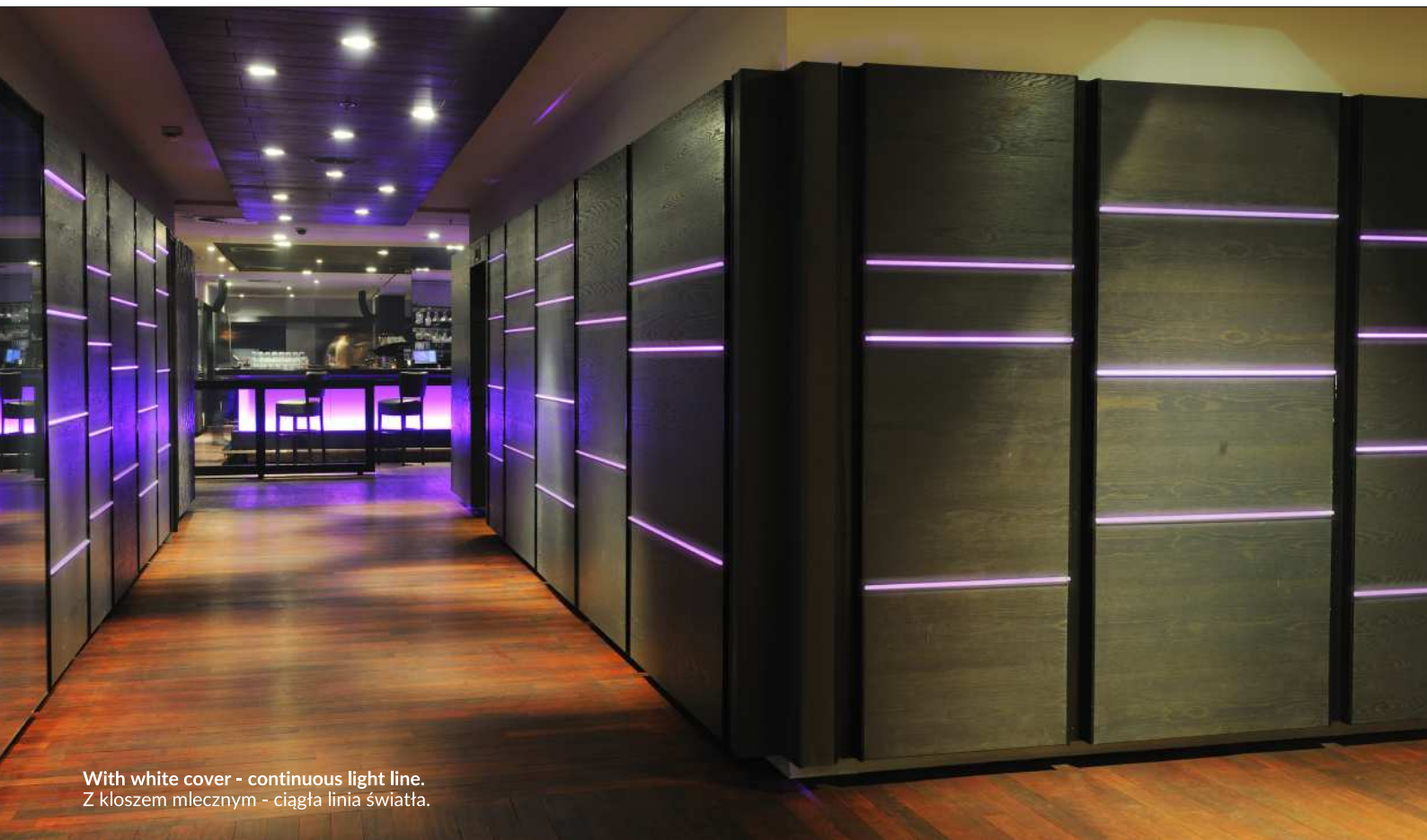

With white cover - continuous light line.
Z kloszem mlecznym - ciągła linia światła.



With glass panel - illumination of sandblasted edge.
Z szybą - podświetlenie piaskowanej krawędzi.

30

VARIO30

2018

LED profiles
profile LED



VARIOUS LIGHT IDEAS

SYSTEM ŚWIETLNYCH WARIACJI

- 18 variations and combinations
- from pendant to recessed
- housing around the powering supply
- continuous light line in angular connections
- unlimited possibilities in creating light

- 18 wariantów i kombinacji
- od wiszących do wpustowych
- obudowa wokół zasilania
- ciągła linia światła w połączeniach kątowych
- nieograniczone możliwości kreowania światła

an example / przykład
variant 18

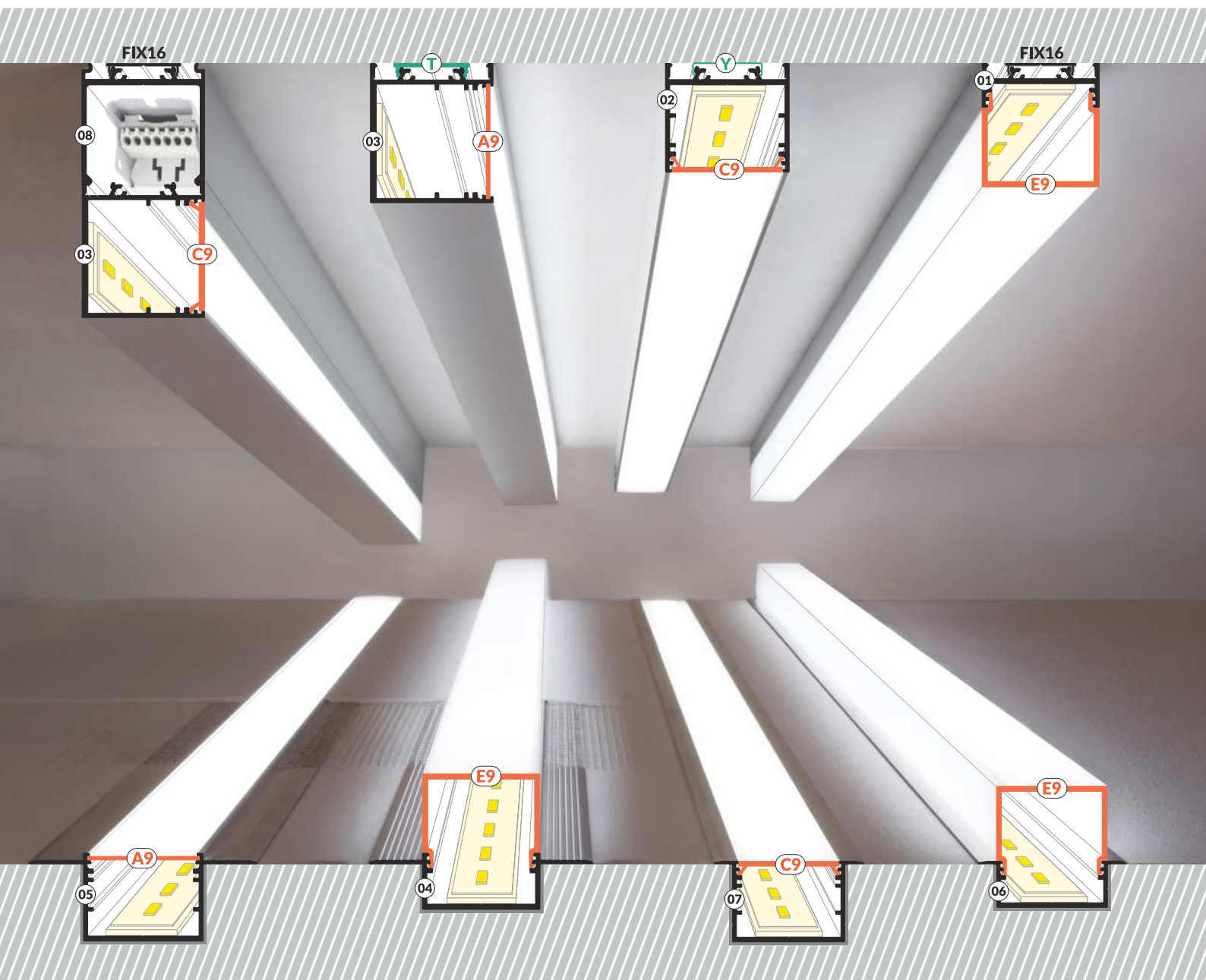
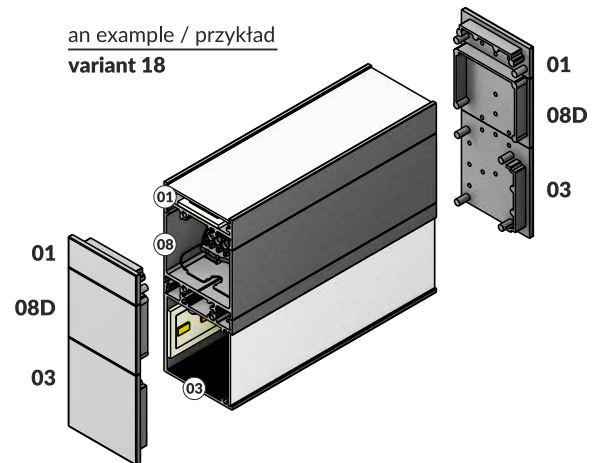

PROMOTED VARIANTS PROMOWANE WARIANTY

variant 27 - pendant 09-08-02-C9
 wariant 27 - wiszący 09-08-02-C9

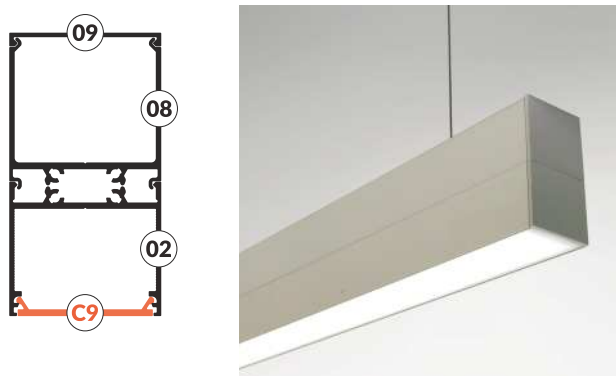

variant 15 - ceiling FIX16-08-01-E9
 wariant 15 - sufitowy FIX16-08-01-E9

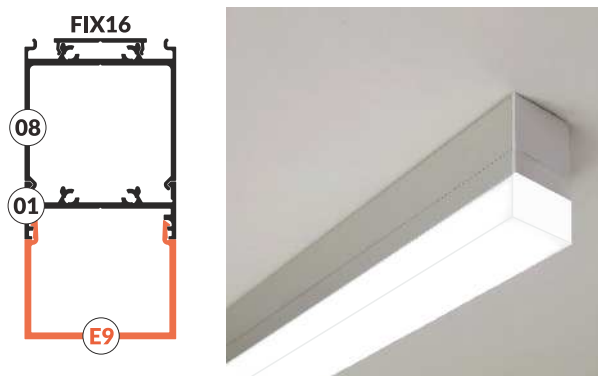

variant 32 - wall side FIX16-08-03-A9
 wariant 32 - ścienny boczny FIX16-08-03-A9

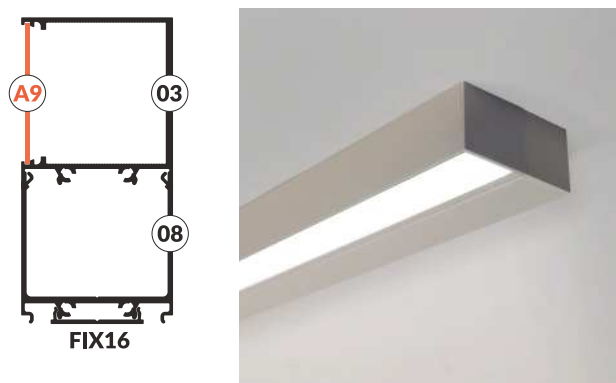

variant 11 - furniture FIX16-01-C9
 wariant 11 - meblowy FIX16-01-C9

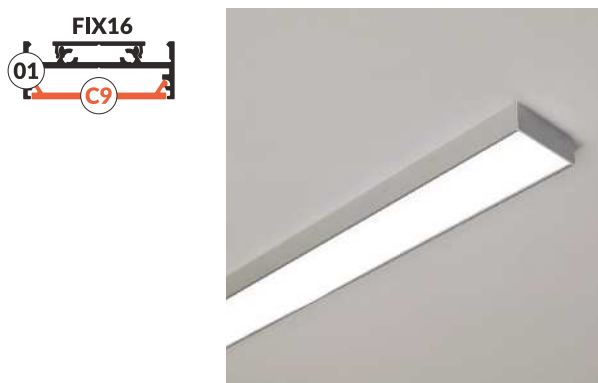

variant 06 - recessed 06-E9
 wariant 06 - wpustowy 06-E9



variant 05 - recessed 05-A9 spackle mounting
 wariant 05 - wpustowy 05-A9 do szpachlowania

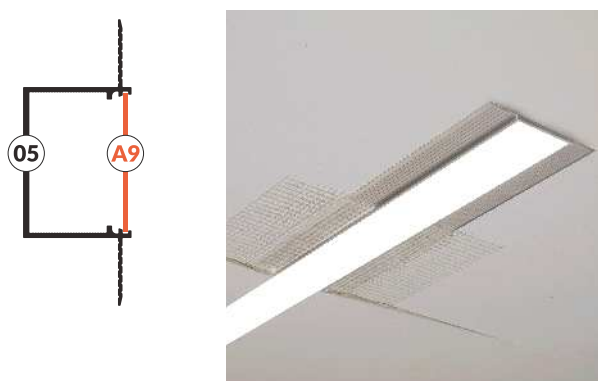

PROMOTED VARIANTS PROMOWANE WARIANTY

BASIC VARIANTS / WARIANTY PODSTAWOWE

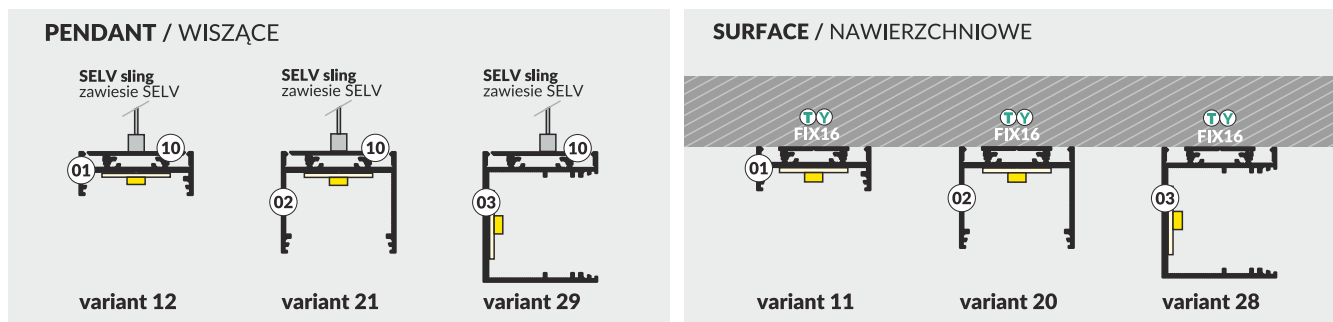

VARIANTS WITH POWER SUPPLY COVER / WARIANTY Z OSŁONĄ ZASILACZA

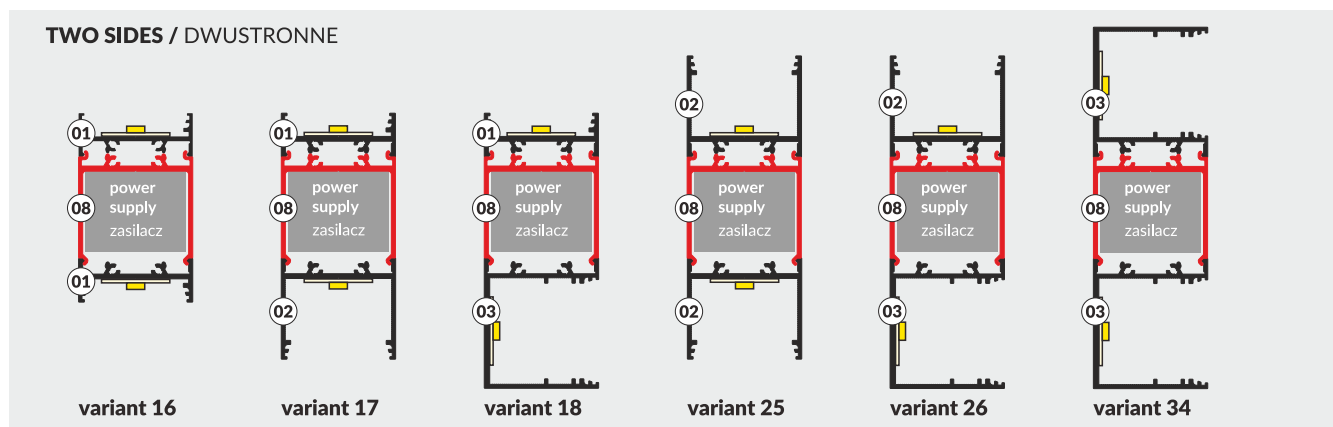
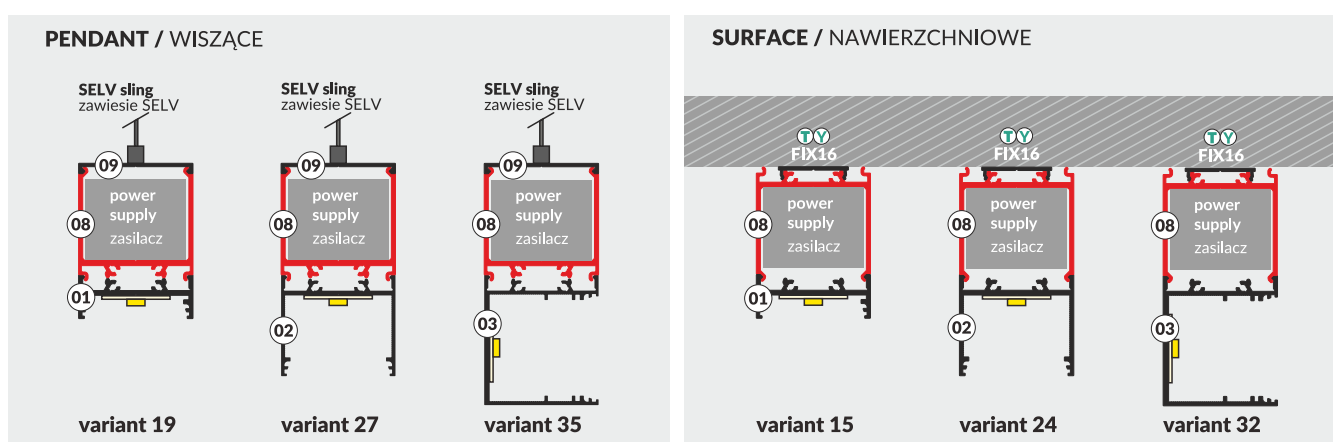

RECESSED VARIANTS / WARIANTY WPUSTOWE

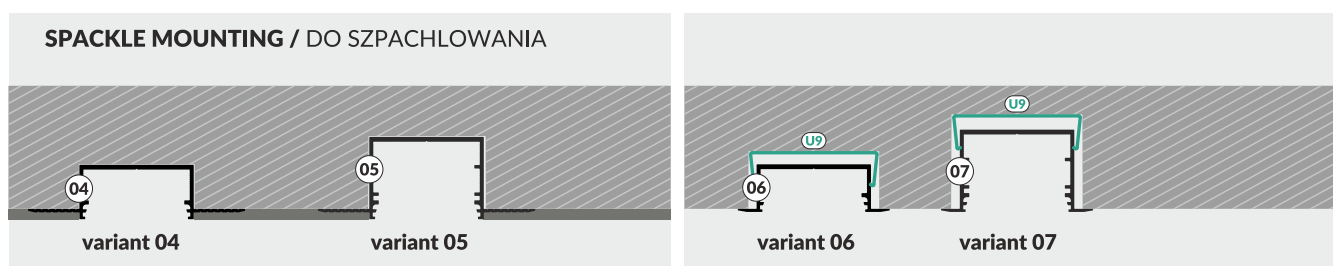

VARIO30

SURFACE MOUNTED / NAWIERZCHNIOWE

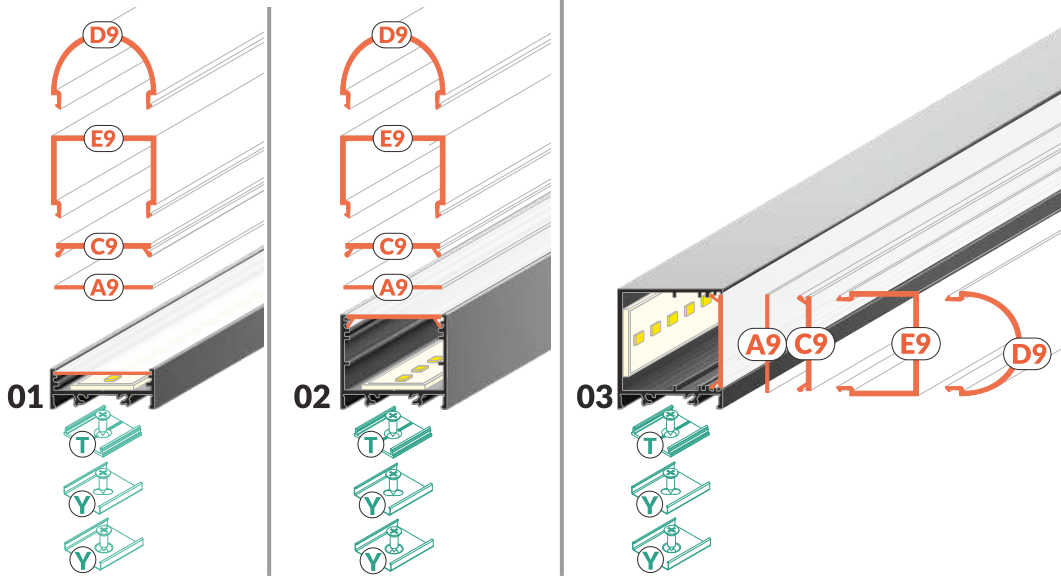

POWER SUPPLY COVER OSŁONA ZASILACZA

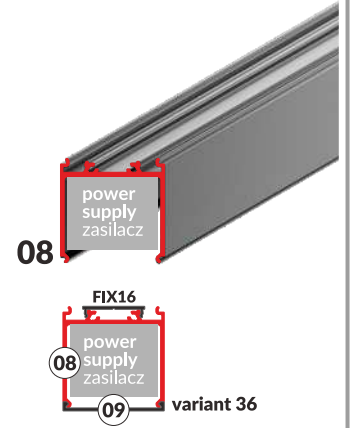

ASSISTANT PROFILES / PROFILE POMOCNICZE

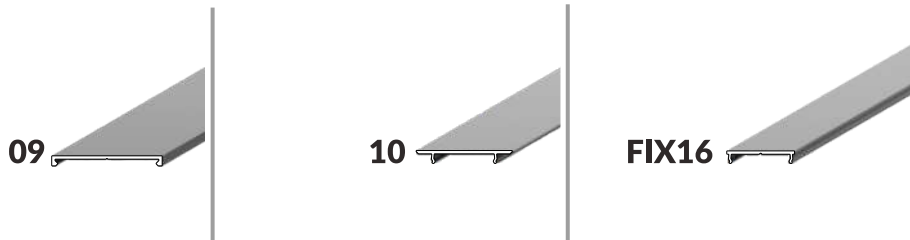

RECESSED SPACKLE FLANGE MOUNTED WPUSTOWE DO SZPACHLOWANIA

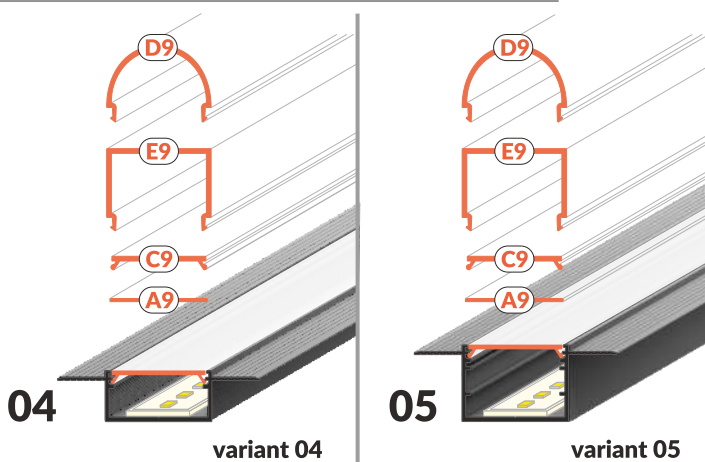

RECESSED MOUNTED WPUSTOWE

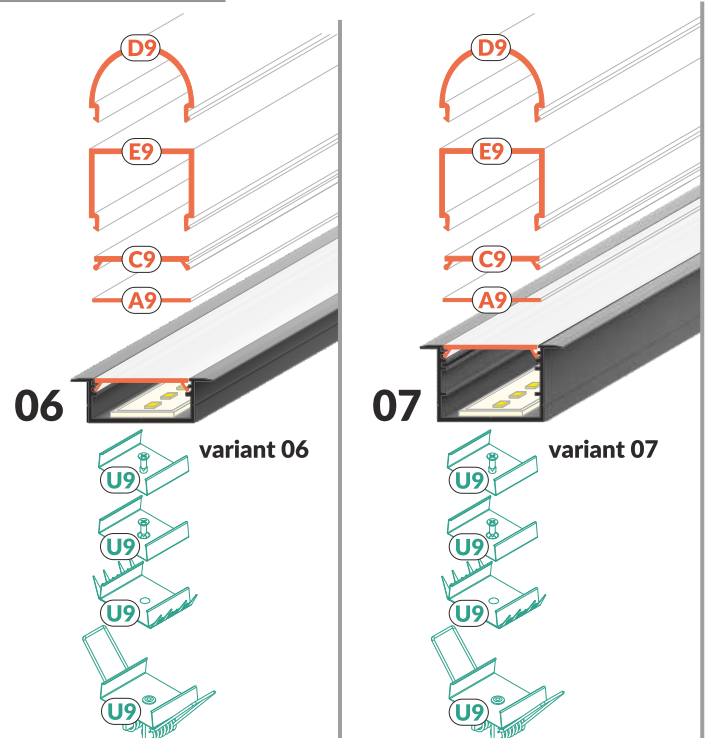

SURFACE PROFILES

PROFILE NAWIERZCHNIOWE



VARIO30-01 > 7.6
VARIO30-02 > 7.6
VARIO30-03 > 7.6
VARIO30-08 > 7.6

VARIO30-09 > 7.7
VARIO30-10 > 7.7
FIX16 > 7.7

mountings / mocowania > 7.8
endings / zaślepki > 7.9
connectors / łączniki > 7.12

others / pozostałe > 7.18
diffusers / klosze > 7.19

SURFACE, POWER SUPPLY COVER NAWIERZCHNIOWE, OSŁONA ZASILANIA

Available in stock
Dostępny na magazynie



LED profile / profil LED VARIO30-01

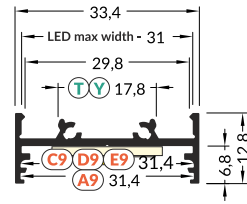
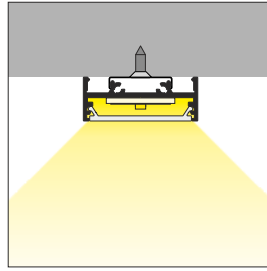

| white | anodized | black | raw |
|----------|-----------|----------|----------|
| biały | anodowany | czarny | surowy |
| V3020001 | V3020020 | V3020021 | V3020000 |

INDEX = 1 pc, length 2000 mm, package = 10 pcs / INDEKS = 1 szt., długość 2000 mm, opakowanie = 10 szt.

LED profile / profil LED VARIO30-02

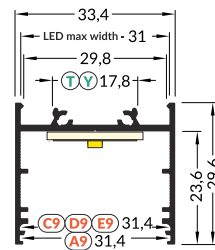
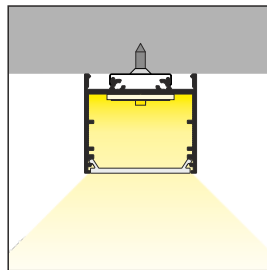

| white | anodized | black | raw |
|----------|-----------|----------|----------|
| biały | anodowany | czarny | surowy |
| V3060001 | V3060020 | V3060021 | V3060000 |

INDEX = 1 pc, length 2000 mm, package = 10 pcs / INDEKS = 1 szt., długość 2000 mm, opakowanie = 10 szt.

LED profile / profil LED VARIO30-03

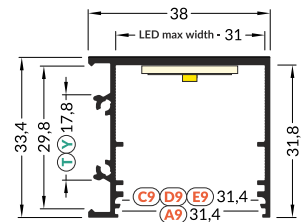
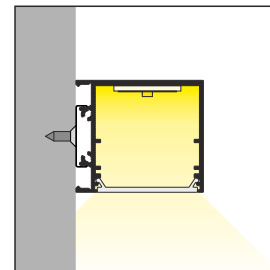
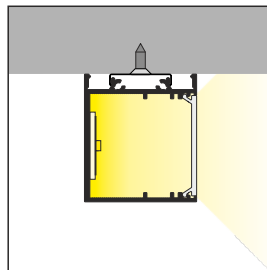

| white | anodized | black | raw |
|----------|-----------|----------|----------|
| biały | anodowany | czarny | surowy |
| V3100001 | V3100020 | V3100021 | V3100000 |

INDEX = 1 pc, length 2000 mm, package = 10 pcs / INDEKS = 1 szt., długość 2000 mm, opakowanie = 10 szt.

power supply profile / profil zasilający VARIO30-08

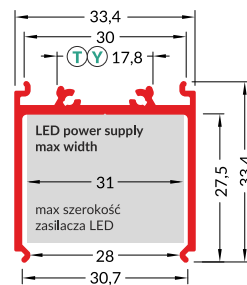
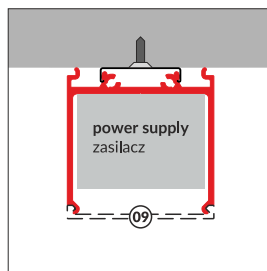

| white | anodized | black | raw |
|----------|-----------|----------|----------|
| biały | anodowany | czarny | surowy |
| V3300001 | V3300020 | V3300021 | V3300000 |

INDEX = 1 pc, length 2000 mm, package = 10 pcs / INDEKS = 1 szt., długość 2000 mm, opakowanie = 10 szt.



cover / osłona
VARIO30-09

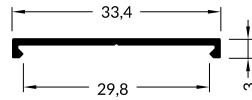

| white | anodized | black | raw |
|-----------------|-----------------|-----------------|-----------------|
| biały | anodowany | czarny | surowy |
| V3340001 | V3340020 | V3340021 | V3340000 |

INDEX = 1 pc, length 2000 mm, package = 10 pcs / INDEKS = 1 szt., długość 2000 mm, opakowanie = 10 szt.

cover / osłona
VARIO30-10

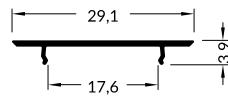

| white | anodized | black | raw |
|-----------------|-----------------|-----------------|-----------------|
| biały | anodowany | czarny | surowy |
| V3380001 | V3380020 | V3380021 | V3380000 |

INDEX = 1 pc, length 2000 mm, package = 10 pcs / INDEKS = 1 szt., długość 2000 mm, opakowanie = 10 szt.

LED profile / profil LED
FIX16

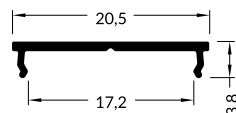

| white | anodized | black | raw |
|-----------------|-----------------|-----------------|-----------------|
| biały | anodowany | czarny | surowy |
| C6020001 | C6020020 | C6020021 | C6020000 |

INDEX = 1 pc, length 2000 mm, package = 10 pcs / INDEKS = 1 szt., długość 2000 mm, opakowanie = 10 szt.



Y flexible mounting plate uchwyt Y sprężysty

material: stainless steel
materiał: stal nierdzewna

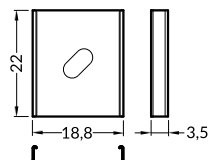

cone Y flexible mounting plate uchwyt Y sprężysty cone

material: stainless steel
materiał: stal nierdzewna

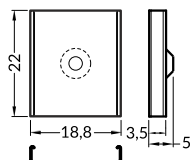

T mounting plate uchwyt T

material: aluminium
materiał: aluminium

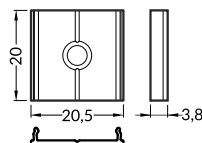

tilted bracket uchwyt uchylny

material: stainless steel, plastic
materiał: stal nierdzewna, tworzywo

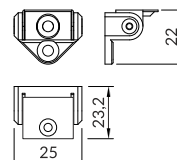

please note you need
the Y mounting plate
that is not included
do kompletu należy dokupić
uchwyt Y sprężysty cone

| mountings | inox | raw aluminium | | |
|--|----------|------------------|----------|----------|
| uchwyty | inox | surowe aluminium | | |
| Y flexible mounting plate / uchwyt Y sprężysty | A2090019 | - | | |
| cone Y flexible mounting plate / uchwyt Y sprężysty cone | A2130019 | - | | |
| T mounting plate / uchwyt T | - | C6960000 | | |
| | white | silver | black | grey |
| | biały | srebro | czarny | szary |
| tilted bracket / uchwyt uchylny | 67230001 | 67230040 | 67230002 | 67230022 |

INDEX = 1 set, package of 10 sets = 20 pcs / INDEKS = 1 komplet, opakowanie zawiera 10 kompletów = 20 szt.



diffuser / cover / profile
klosz / osłona / profil

ending dedicated to VARIO30-08 profile
zaślepka dedykowana do profilu 08

bottom of the LED profile
dół profilu LED

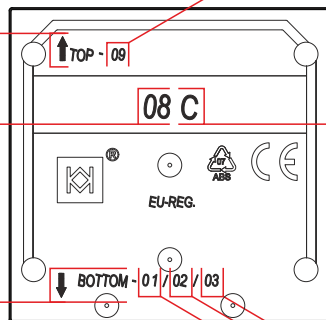

names of profiles fitting with chosen ending:
- VARIO30-09 cover

nazwy profili pasujących do wybranej zaślepki:
- osłona VARIO30-09

type of variant
typ wariantu

names of profiles fitting with chosen ending:
- LED profile VARIO30-01
- LED profile VARIO30-02
- LED profile VARIO30-03

nazwy profili pasujących do wybranej zaślepki:
- profil LED VARIO30-01
- profil LED VARIO30-02
- profil LED VARIO30-03

an example / przykład VARIANT 18

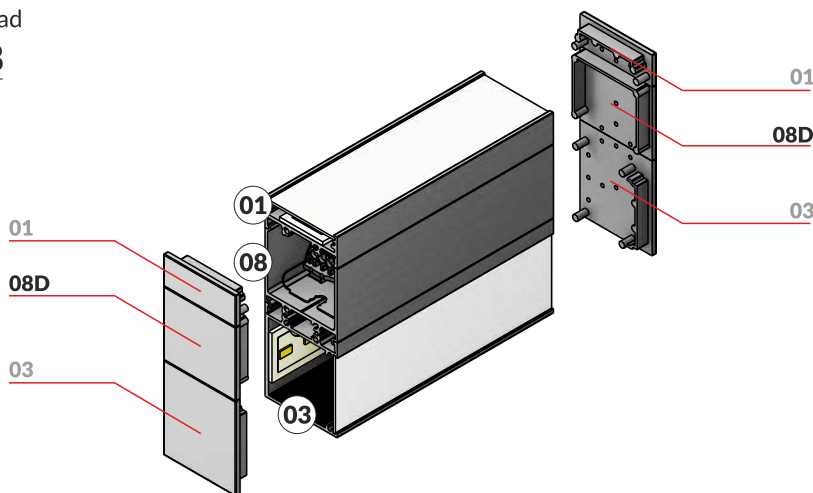

ENDINGS / ZAŚLEPKI

material: ABS

materiał: ABS

VARIO30-01 ending
zaślepka VARIO30-01

VARIO30-02 ending
zaślepka VARIO30-02

VARIO30-03 ending
zaślepka VARIO30-03

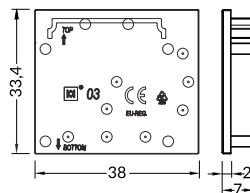
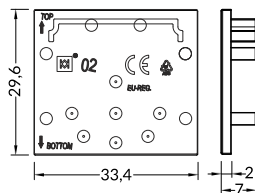
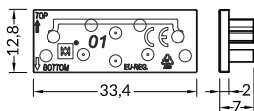
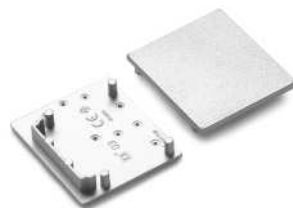

| ending for profile | white | silver | black | grey |
|---------------------|----------|----------|----------|----------|
| zaślepka do profilu | biały | srebro | czarny | szary |
| VARIO30-01 | V4870001 | V4870040 | V4870002 | V4870022 |
| VARIO30-02 | V4880001 | V4880040 | V4880002 | V4880022 |
| VARIO30-03 | V4890001 | V4890040 | V4890002 | V4890022 |

INDEX = 1 set, package of 10 sets = 20 pcs / INDEKS = 1 komplet, opakowanie zawiera 10 kompletów = 20 szt.



VARIO30-08A ending / zaślepka VARIO30-08A

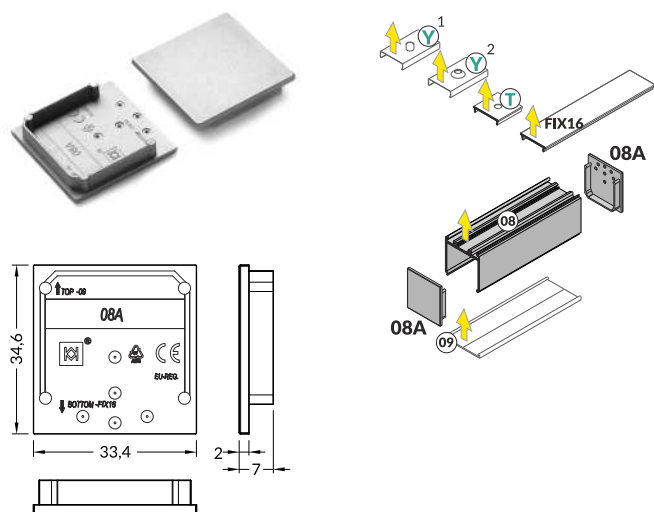

VARIO30-08B ending / zaślepka VARIO30-08B

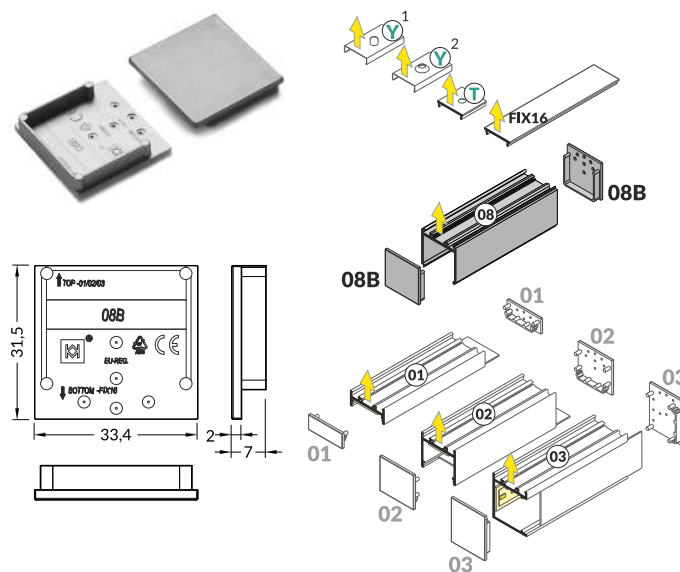

VARIO30-08C ending / zaślepka VARIO30-08C

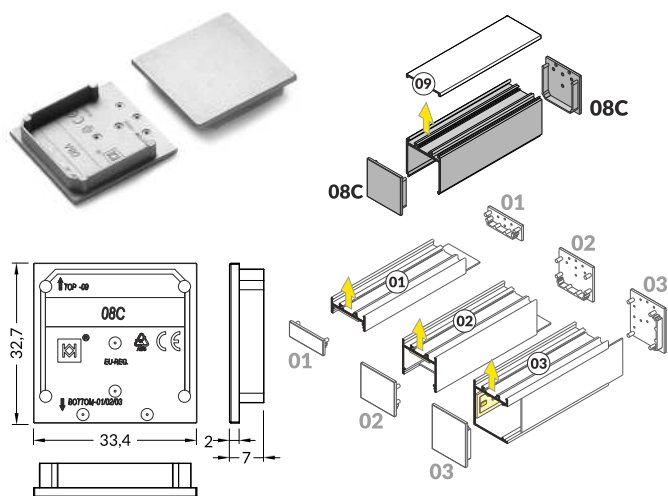

VARIO30-08D ending / zaślepka VARIO30-08D

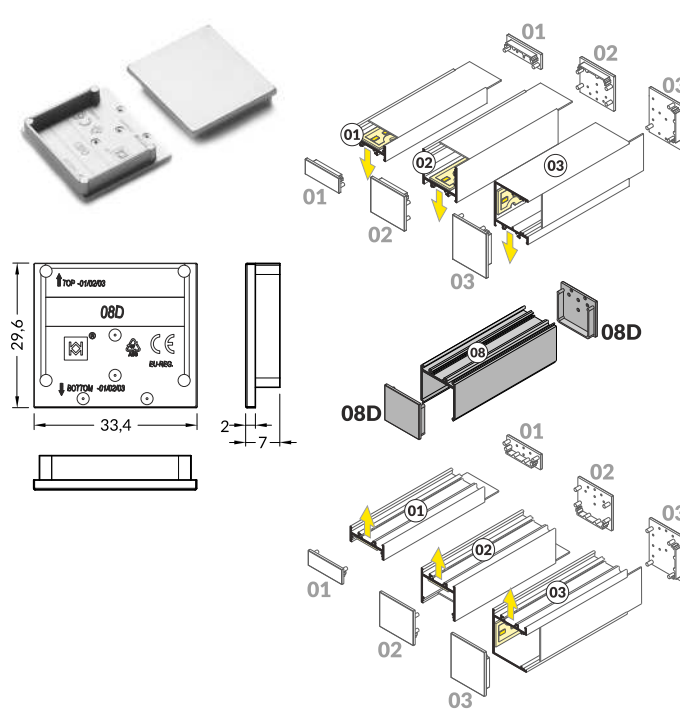

| ending for profile | white | silver | black | grey |
|---------------------|----------|----------|----------|----------|
| zaślepka do profilu | biały | srebro | czarny | szary |
| VARIO30-08ABCD | V4600001 | V4600040 | V4600002 | V4600022 |

INDEX = 1 set = 2 x 08A + 2 x 08B + 2 x 08C + 2x08D / INDEKS = 1 kpl = 2 x 08A + 2 x 08B + 2 x 08C + 2x08D



VARIO30-16-E9 metal ending / zaślepka VARIO30-16-E9 metal

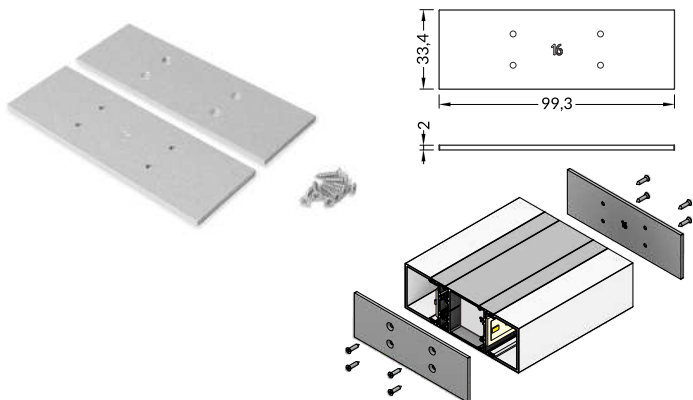

VARIO30-19-E9 metal ending / zaślepka VARIO30-19-E9 metal

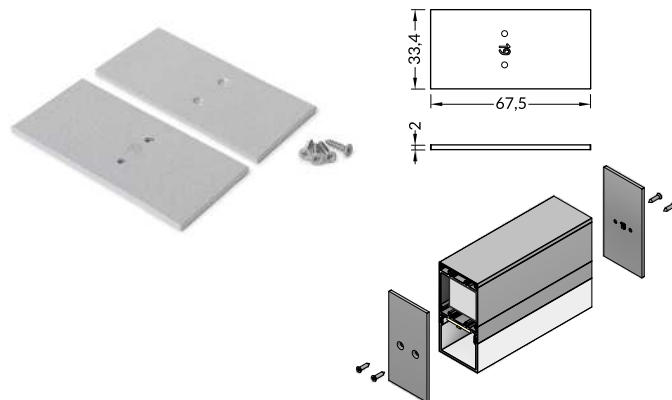

VARIO30-27 metal ending / zaślepka VARIO30-27 metal

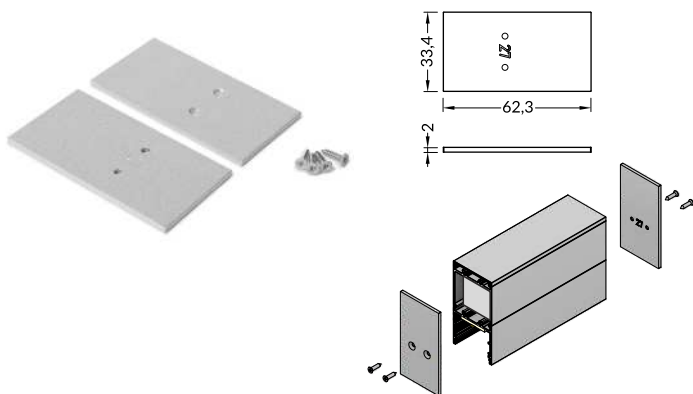

VARIO30-32 metal ending / zaślepka VARIO30-32 metal

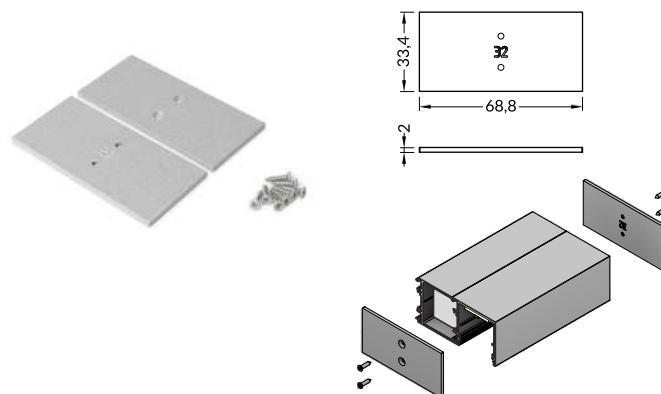

VARIO30-34 metal ending / zaślepka VARIO30-34 metal

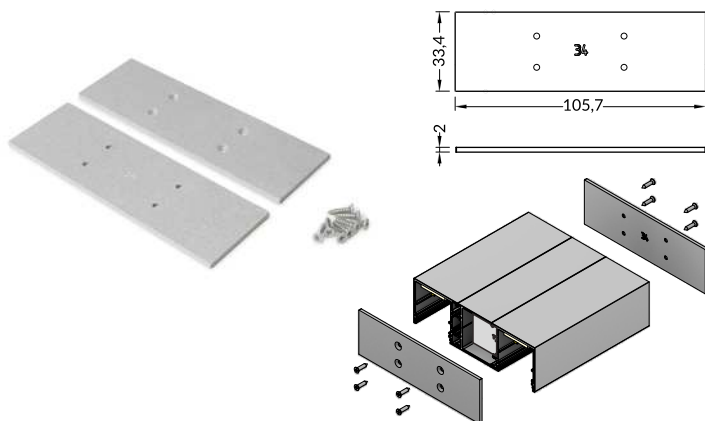

| ending for variant | white | silver | black |
|----------------------|-----------|-----------|-----------|
| zaślepka do wariantu | biały | srebro | czarny |
| VARIO30-16 | V4550001s | V4550022s | V4550002s |
| VARIO30-19 | V4560001s | V4560022s | V4560002s |
| VARIO30-27 | V4570001s | V4570022s | V4570002s |
| VARIO30-32 | V4580001s | V4580022s | V4580002s |
| VARIO30-34 | V4590001s | V4590022s | V4590002s |

INDEX = 1 set = 2 pcs / INDEKS = 1 komplet = 2 szt.

for profiles / do profili

VARIO30-02

60 deg / st

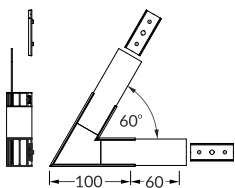

90 deg / st

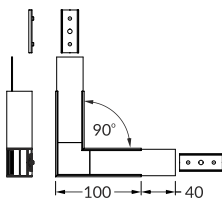

90 deg bent / st gięty

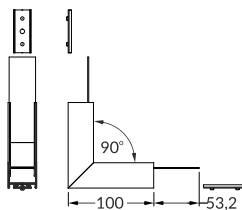

120 deg / st

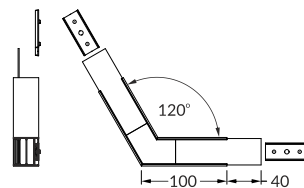

135 deg / st

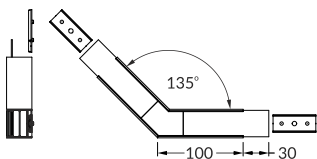

180 deg / st

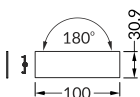

270 deg bent / st gięty

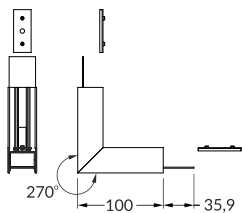

| white | anodized | black |
|-------|-----------|--------|
| biały | anodowany | czarny |

| | | | |
|---|-----------|-----------|-----------|
| VARIO30-02 connector 60 deg / łącznik VARIO30-02 60 st | V4660001s | V4660020s | V4660021s |
| VARIO30-02 connector 90 deg / łącznik VARIO30-02 90 st | V4670001s | V4670020s | V4670021s |
| VARIO30-02 connector 90 deg bent / łącznik VARIO30-02 90 st gięty | V4680001s | V4680020s | V4680021s |
| VARIO30-02 connector 120 deg / łącznik VARIO30-02 120 st | V4690001s | V4690020s | V4690021s |
| VARIO30-02 connector 135 deg / łącznik VARIO30-02 135 st | V4700001s | V4700020s | V4700021s |
| VARIO30-0203 connector 180 deg / łącznik VARIO30-0203 180 st | - | - | V4640000s |
| VARIO30-02 connector 270 deg bent / łącznik VARIO30 270 st gięty | V4710001s | V4710020s | V4710021s |

INDEX = 1 pc / INDEKS = 1 szt.

for profiles / do profili

VARIO30-03

180 deg / st

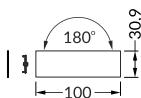

| white | anodized | black |
|-------|-----------|--------|
| biały | anodowany | czarny |

| | | | |
|--|---|---|-----------|
| VARIO30-0203 connector 180 deg / łącznik VARIO30-0203 180 st | - | - | V4640000s |
|--|---|---|-----------|

INDEX = 1 pc / INDEKS = 1 szt.

RECESSED PROFILES PROFILE WPUSTOWE

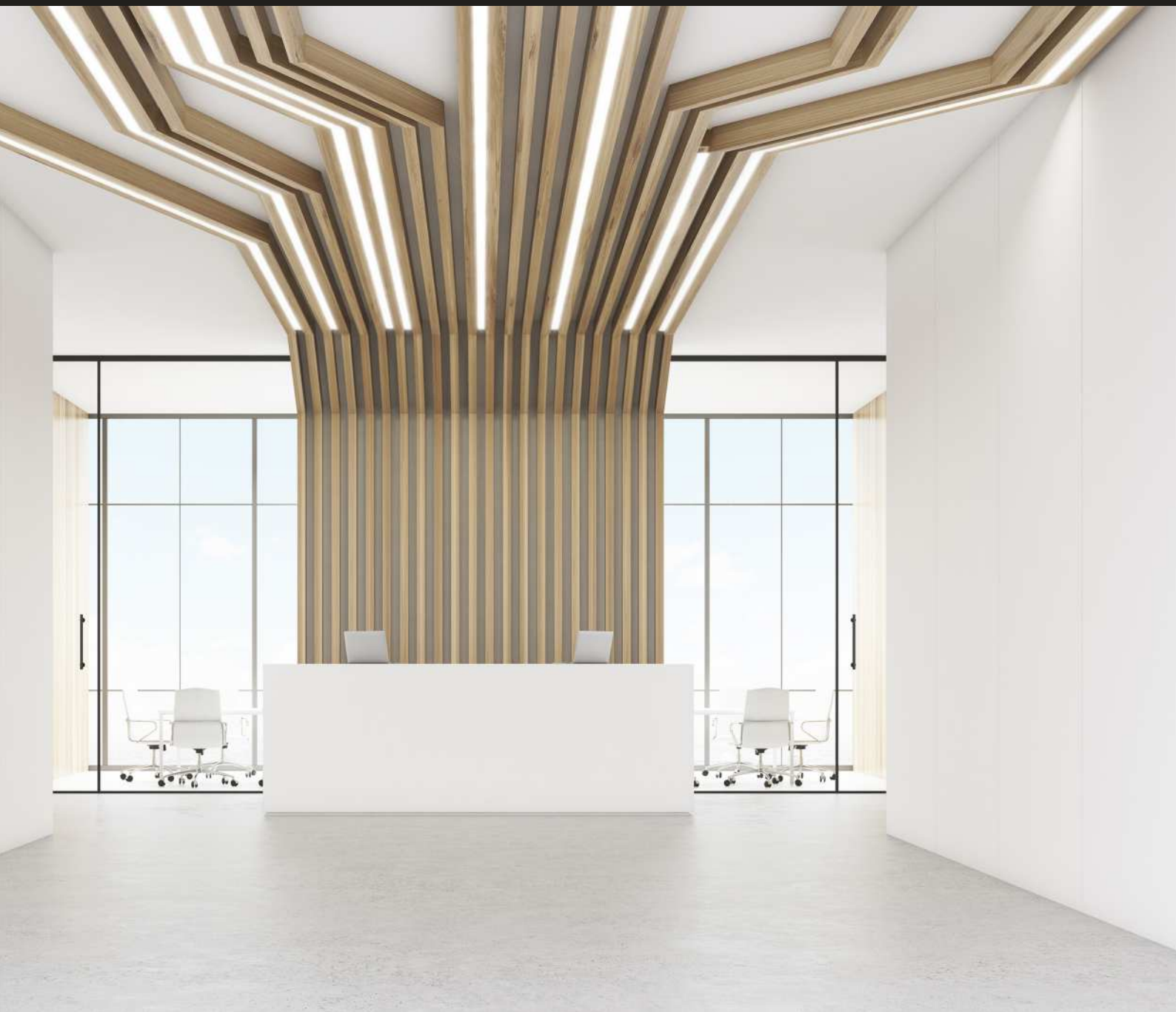

VARIO30-04 > 7.14
VARIO30-05 > 7.14
VARIO30-06 > 7.14
VARIO30-07 > 7.14

mountings / mocowania > 7.15
endings / zaślepki > 7.15
connectors / łączniki > 7.16

others / pozostałe > 7.18
diffusers / klosze > 7.19

RECESSED PROFILES PROFILE WPUSTOWE

Available in stock
Dostępny na magazynie



LED profile / profil LED VARIO30-04

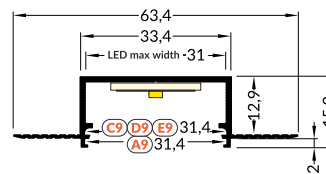
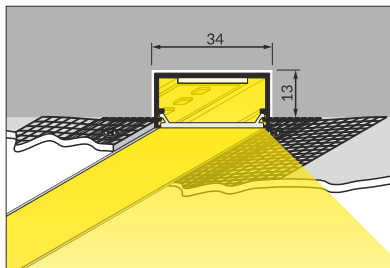

| white | anodized | black | raw |
|----------|-----------|--------|----------|
| biały | anodowany | czarny | surowy |
| V3140001 | V3140020 | - | V3140000 |

INDEX = 1 pc, length 2000 mm, package = 10 pcs / INDEKS = 1 szt., długość 2000 mm, opakowanie = 10 szt.

LED profile / profil LED VARIO30-05

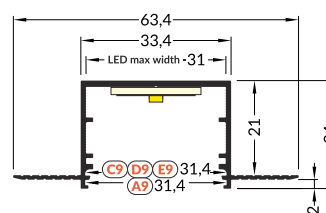
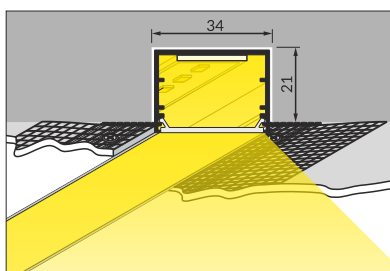

| white | anodized | black | raw |
|----------|-----------|--------|----------|
| biały | anodowany | czarny | surowy |
| V3180001 | V3180020 | - | V3180000 |

INDEX = 1 pc, length 2000 mm, package = 10 pcs / INDEKS = 1 szt., długość 2000 mm, opakowanie = 10 szt.

LED profile / profil LED VARIO30-06

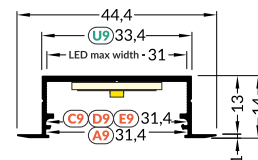
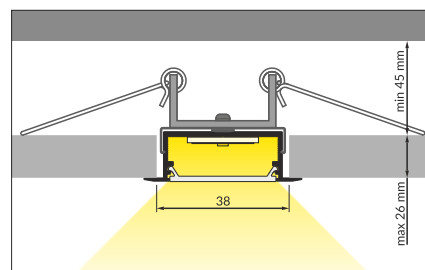
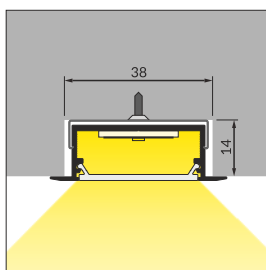

| white | anodized | black | raw |
|----------|-----------|----------|----------|
| biały | anodowany | czarny | surowy |
| V3220001 | V3220020 | V3220021 | V3220000 |

INDEX = 1 pc, length 2000 mm, package = 10 pcs / INDEKS = 1 szt., długość 2000 mm, opakowanie = 10 szt.

LED profile / profil LED VARIO30-07

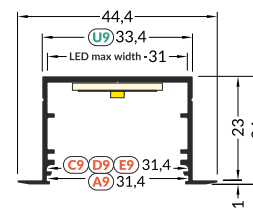
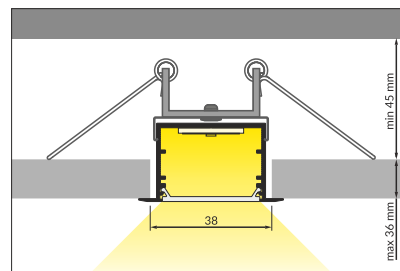
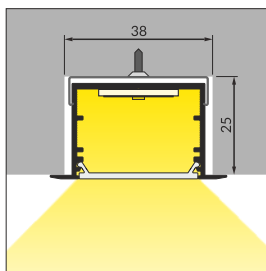

| white | anodized | black | raw |
|----------|-----------|----------|----------|
| biały | anodowany | czarny | surowy |
| V3260001 | V3260020 | V3260021 | V3260000 |

INDEX = 1 pc, length 2000 mm, package = 10 pcs / INDEKS = 1 szt., długość 2000 mm, opakowanie = 10 szt.



MOUNTINGS / MOCOWANIA

U9 mounting plate
uchwyt U9

material: stainless steel
materiał: stal nierdzewna

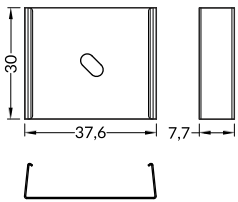

cone U9 mounting plate
uchwyt U9 cone

material: stainless steel
materiał: stal nierdzewna

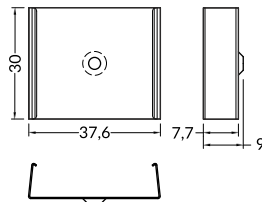

rack U9 mounting plate
uchwyt U9 rack

material: stainless steel
materiał: stal nierdzewna

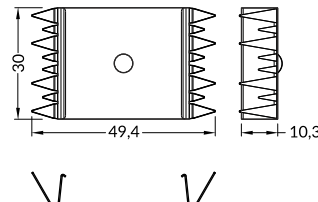

spring U9 mounting plate
uchwyt U9 sprężyna

material: stainless steel, aluminium
materiał: stal nierdzewna, aluminium

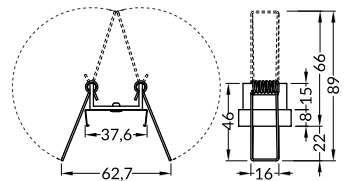

mountings

uchwyty

U9 mounting plate / uchwyt U9

cone U9 mounting plate / uchwyt U9 cone

rack U9 mounting plate / uchwyt U9 rack

INDEX = 1 set, package of 10 sets = 20 pcs / INDEKS = 1 komplet, opakowanie zawiera 10 kompletów = 20 szt.

spring U9 mounting plate / uchwyt U9 sprężyna

INDEX = 2 pcs / INDEKS = 2 szt.

inox

inox

V4840019

V4850019

V4860019

V4620019

ENDINGS / ZAŚLEPKI

material: ABS

materiał: ABS

VARIO30-04 ending
zaślepka VARIO30-04

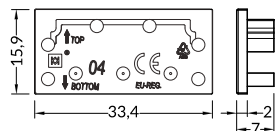

VARIO30-05 ending
zaślepka VARIO30-05

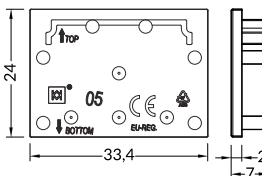
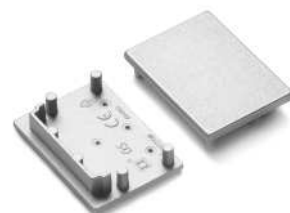

VARIO30-06 ending
zaślepka VARIO30-06

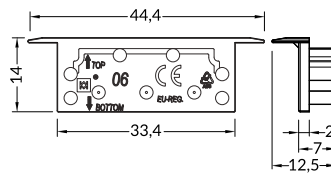

VARIO30-07 ending
zaślepka VARIO30-07

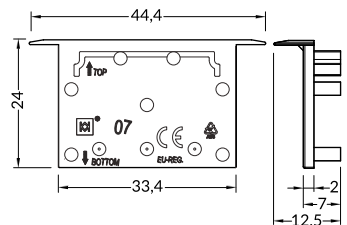
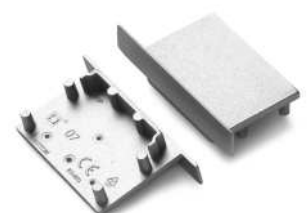

ending for profile

white

silver

black

grey

zaślepka do profilu

biały

srebro

czarny

szary

VARIO30-04

V4900001

V4900040

-

V4900022

VARIO30-05

V4910001

V4910040

-

V4910022

VARIO30-06

V4920001

V4920040

V4920040

V4920022

VARIO30-07

V4930001

V4930040

V4930002

V4930022

INDEX = 1 set, package of 10 sets = 20 pcs / INDEKS = 1 komplet, opakowanie zawiera 10 kompletów = 20 szt.

for profiles / do profili

VARIO30-05

60 deg / st

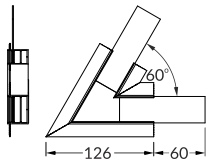

135 deg / st

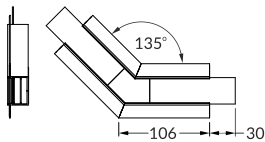

90 deg / st

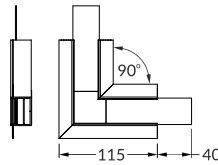

180 deg / st

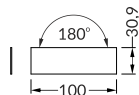

90 deg bent / st gięty

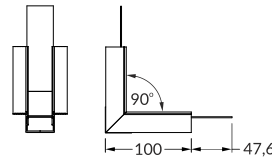

270 deg bent / st gięty

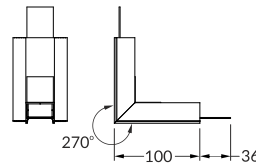

120 deg / st

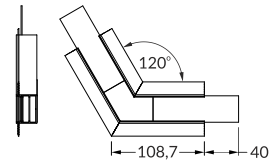

| white | anodized | black |
|-------|-----------|--------|
| biały | anodowany | czarny |

| | | | |
|---|-----------|-----------|-----------|
| VARIO30-05 connector 60 deg / łącznik VARIO30-05 60 st | V4720001s | V4720020s | - |
| VARIO30-05 connector 90 deg / łącznik VARIO30-05 90 st | V4730001s | V4730020s | - |
| VARIO30-05 connector 90 deg bent / łącznik VARIO30-05 90 st gięty | V4740001s | V4740020s | - |
| VARIO30-05 connector 120 deg / łącznik VARIO30-05 120 st | V4750001s | V4750020s | - |
| VARIO30-05 connector 135 deg / łącznik VARIO30-05 135 st | V4760001s | V4760020s | - |
| VARIO30-05 connector 180 deg / łącznik VARIO30-05 180 st | - | - | V4650000s |
| VARIO30-05 connector 270 deg bent / łącznik VARIO30-05 270 st gięty | V4770001s | V4770020s | - |

INDEX = 1 pc / INDEKS = 1 szt.

for profiles / do profili

VARIO30-07

60 deg / st

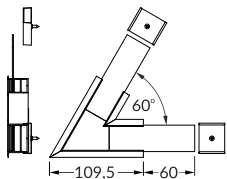

135 deg / st

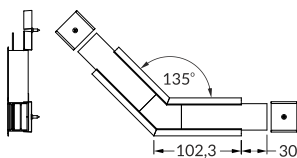

90 deg / st

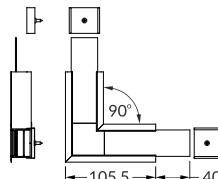

180 deg / st

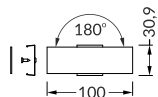

90 deg bent / st gięty

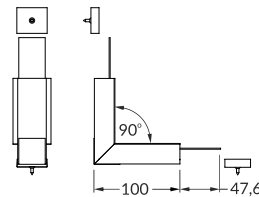

270 deg bent / st gięty

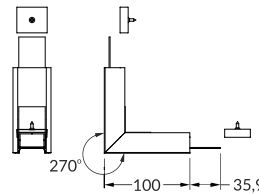

120 deg / st

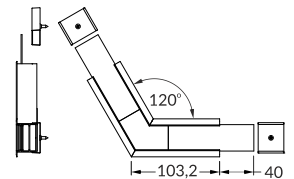

| white | anodized | black |
|-------|-----------|--------|
| biały | anodowany | czarny |

| | | | |
|---|-----------|-----------|-----------|
| VARIO30-07 connector 60 deg / łącznik VARIO30-07 60 st | V4780001s | V4780020s | V4780002s |
| VARIO30-07 connector 90 deg / łącznik VARIO30-07 90 st | V4790001s | V4790020s | V4790002s |
| VARIO30-07 connector 90 deg bent / łącznik VARIO30-07 90 st gięty | V4800001s | V4800020s | V4800002s |
| VARIO30-07 connector 120 deg / łącznik VARIO30-07 120 st | V4810001s | V4810020s | V4810002s |
| VARIO30-07 connector 135 deg / łącznik VARIO30-07 135 st | V4820001s | V4820020s | V4820002s |
| VARIO30-07 connector 180 deg / łącznik VARIO30-07 180 st | - | - | V4610000s |
| VARIO30-07 connector 270 deg bent / łącznik VARIO30-07 270 st gięty | V4830001s | V4830020s | V4830002s |

INDEX = 1 pc / INDEKS = 1 szt.

SYSTEM ACCESSORIES

AKCESORIA SYSTEMOWE

VARIO30 reflector + **VARIO30-1 LED clamp**
odbłyśnik VARIO30 + docisk LED VARIO30-1

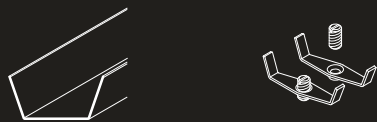

Recommended for profiles:
Rekomendowane dla profili:
02, 03 > 6
05, 07 > 14
and diffusers: / oraz kloszy:
A9, C9, D9, E9 > 18

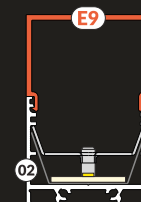

VARIO30 LED mounting + **VARIO30 LED clamp**
mocowanie LED VARIO30 + docisk LED VARIO30



Recommended for profiles:
Rekomendowane dla profili:
02, 03 > 6
05, 07 > 14
and diffusers: / oraz kloszy:
A9, C9, D9, E9 > 18

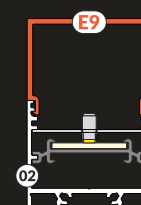
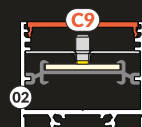

VARIO30-1 LED clamp
docisk LED VARIO30-1



Recommended for profiles:
Rekomendowane dla profili:
02, 03 > 6
05, 07 > 14
and diffusers: / oraz kloszy:
A9, C9, D9, E9 > 18



VARIO30 LED clamp
docisk LED VARIO30



Recommended for profiles:
Rekomendowane dla profili:
04, 06 > 14
and diffusers: / oraz kloszy:
A9, C9, D9, E9 > 18

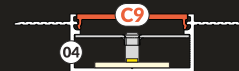

others / pozostałe
diffusers / klosze

> 7.18
> 7.19



VARIO30 LED clamp docisk LED VARIO30

material: steel, plastic
materiał: stal, tworzywo

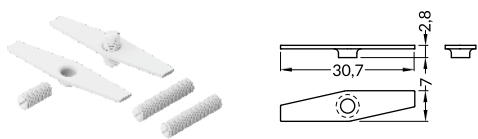

VARIO30-1 LED clamp docisk LED VARIO30-1

material: steel, plastic
materiał: stal, tworzywo

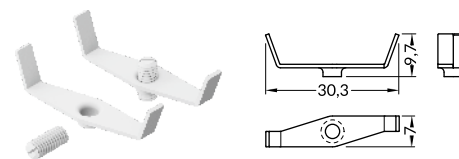

white painted

biały malowany

VARIO30 LED clamp / docisk LED VARIO30

V4630001

VARIO30-1 LED clamp / docisk LED VARIO30-1

V4520001

INDEX = 1 set, package of 10 sets = 20 pcs / INDEKS = 1 komplet, opakowanie zawiera 10 kompletów = 20 szt.

VARIO30 reflector odbłyśnik VARIO30

material: aluminium
materiał: aluminium

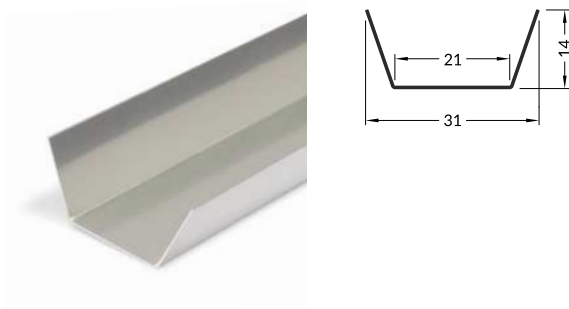

VARIO30 LED mounting mocowanie LED VARIO30

material: aluminium
materiał: aluminium

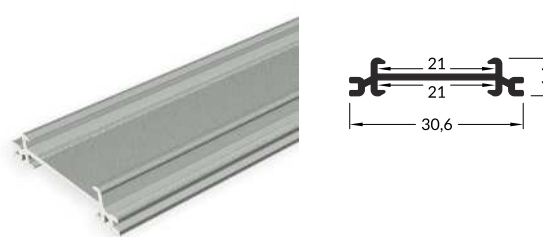

raw aluminium

surowe aluminium

VARIO30 reflector / odbłyśnik VARIO30

V3620000

VARIO30 LED mounting / mocowanie LED VARIO30

-

V3580000

INDEX = 1 pc, length 2000 mm, package = 10 pcs / INDEKS = 1 szt., długość 2000 mm, opakowanie = 10 szt.



A9 slide diffuser / klosz A9 wsuwany

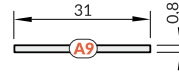
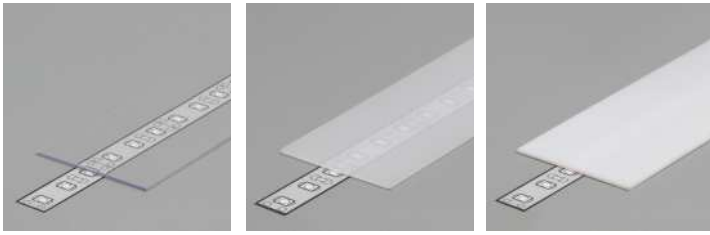

transparent
material: PC
transparentny
material: PC

frosted
material: PP
szron
material: PP

white
material: PP
mleczny
material: PP



Note! Dimensions of the space to install LED source / Uwaga! Wymiary przestrzeni do zamontowania źródła LED

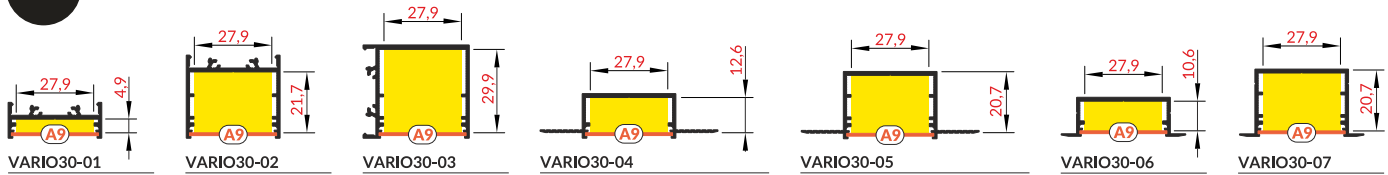

| | transparent | frosted | white |
|--|---------------|---------|---------|
| | transparentny | szron | mleczny |

| | | | |
|--------------------------------------|----------|----------|----------|
| A9 slide diffuser / klosz A9 wsuwany | V3420016 | V3420039 | V3420038 |
|--------------------------------------|----------|----------|----------|

INDEX = 1 pc, length 2000 mm, package = 10 pcs / INDEKS = 1 szt., długość 2000 mm, opakowanie = 10 szt.

C9 click diffuser / klosz C9 klik

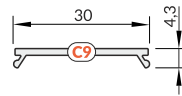

transparent
material: PMMA
transparentny
material: PMMA

white
material: PMMA
mleczny
material: PMMA



Note! Dimensions of the space to install LED source / Uwaga! Wymiary przestrzeni do zamontowania źródła LED

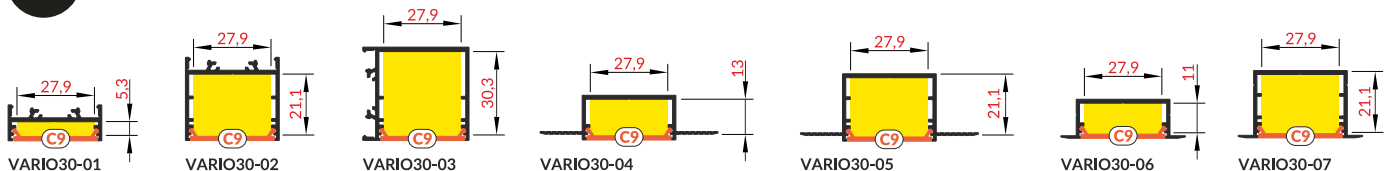

| | transparent | frosted | white |
|--|---------------|---------|---------|
| | transparentny | szron | mleczny |

| | | | |
|-----------------------------------|----------|---|----------|
| C9 click diffuser / klosz C9 klik | V3460016 | - | V3460038 |
|-----------------------------------|----------|---|----------|

INDEX = 1 pc, length 2000 mm, package = 10 pcs / INDEKS = 1 szt., długość 2000 mm, opakowanie = 10 szt.



E9 click diffuser / klosz E9 klik

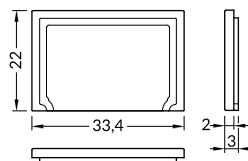
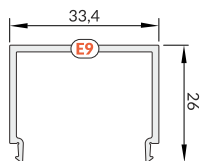

white
material: PMMA
mleczny
materiał: PMMA

white
material: PMMA
mleczny
materiał: PMMA



Note! Dimensions of the space to install LED source / Uwaga! Wymiary przestrzeni do zamontowania źródła LED

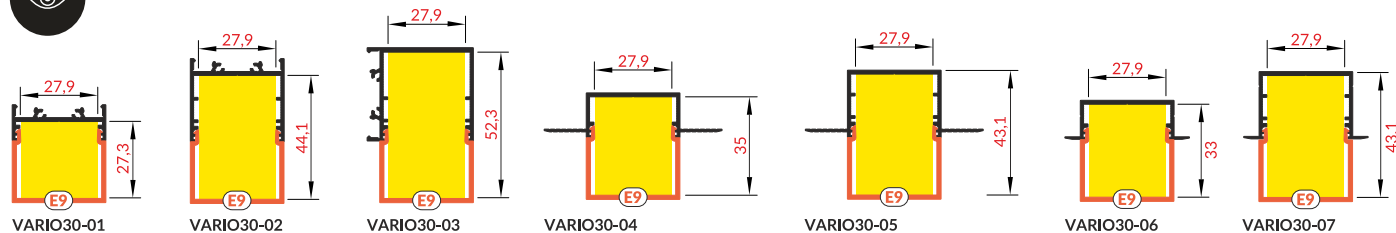

VARIO30-01

VARIO30-02

VARIO30-03

VARIO30-04

VARIO30-05

VARIO30-06

VARIO30-07

transparent frosted white

transparentny szron mleczny

E9 click diffuser / klosz E9 klik - - V3500038

INDEX = 1 pc, length 2000 mm, package = 10 pcs / INDEKS = 1 szt., długość 2000 mm, opakowanie = 10 szt.

E9 ending / zaślepka E9 - - V4990038

INDEX = 1 set, package of 10 sets = 20 pcs / INDEKS = 1 komplet, opakowanie zawiera 10 kompletów = 20 szt.

D9 click diffuser / klosz D9 klik

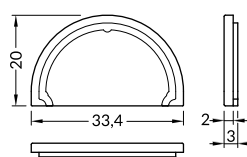
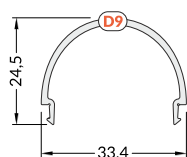

white
material: PMMA
mleczny
materiał: PMMA

white
material: PMMA
mleczny
materiał: PMMA



Note! Dimensions of the space to install LED source / Uwaga! Wymiary przestrzeni do zamontowania źródła LED

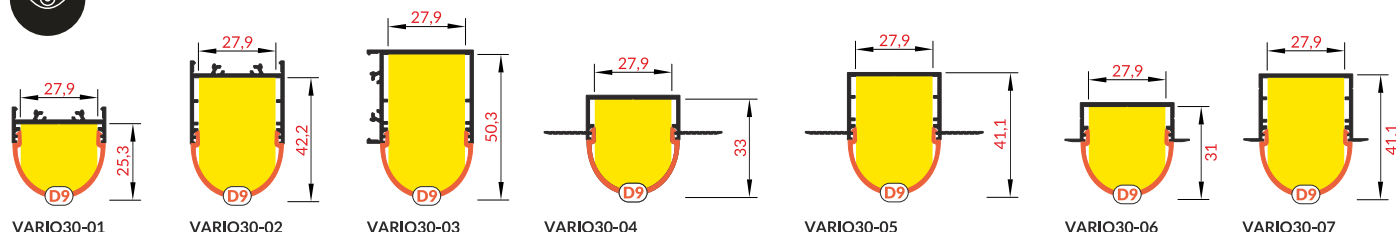

VARIO30-01

VARIO30-02

VARIO30-03

VARIO30-04

VARIO30-05

VARIO30-06

VARIO30-07

transparent frosted white

transparentny szron mleczny

D9 click diffuser / klosz D9 klik - - V3540038

INDEX = 1 pc, length 2000 mm, package = 10 pcs / INDEKS = 1 szt., długość 2000 mm, opakowanie = 10 szt.

D9 ending / zaślepka D9 - - V4980038

INDEX = 1 set, package of 10 sets = 20 pcs / INDEKS = 1 komplet, opakowanie zawiera 10 kompletów = 20 szt.

53

BIG PROFILES
DUŽE PROFILE

2018

LED profiles
profile LED

BIG PROFILES

DUŻE PROFILE





PHIL53 profile / profil PHIL53

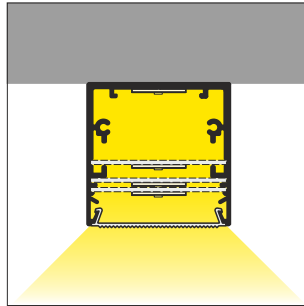
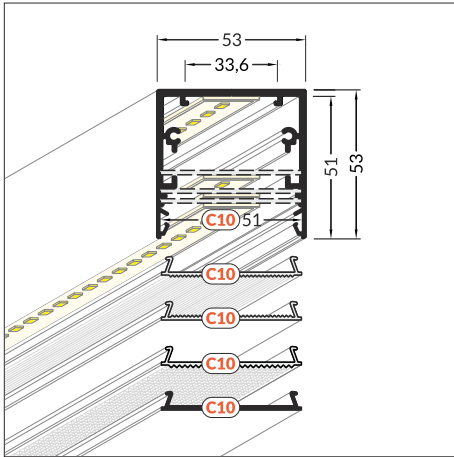

INDEX = 1 pc, length 2000 mm
INDEX = 1 szt., długość 2000 mm

-  white painted
biały malowany
63530001
-  anodized
anodowany
63530020
-  black painted
czarny malowany
63530002
-  raw aluminium
surowe aluminium
63530000

Available lengths / Dostępne długości
1000 mm, 2000 mm, 3000 mm, 4000 mm

ENDINGS / ZAŚLEPKI

PHIL53 ending
colours: white, silver, black, grey
material: ABS
zaślepka PHIL53
kolory: biały, srebrny, czarny, szary
materiał: ABS

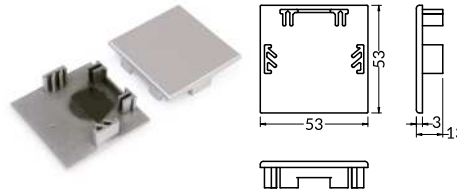

INDEX = 1 set = 2 pcs
INDEKS = 1 komplet = 2 szt.

-  white
biały **63640001**
-  silver
srebrny **63640040**
-  black
czarny **63640002**
-  grey
szary **63640022**

PHIL recessed profile / profil PHIL wpust

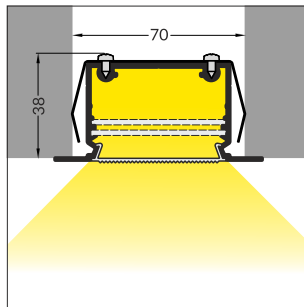
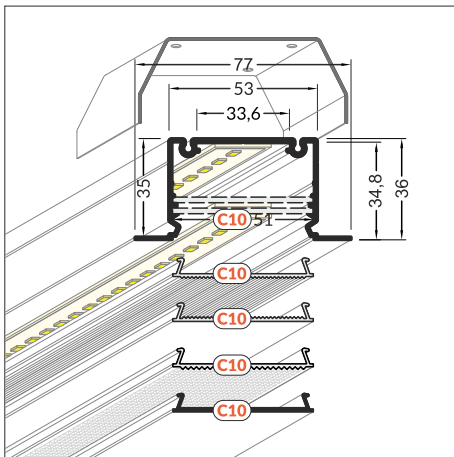

INDEX = 1 pc, length 2000 mm
INDEX = 1 szt., długość 2000 mm

-  white painted
biały malowany
97100001
-  anodized
anodowany
97100020
-  black painted
czarny malowany
97100002
-  raw aluminium
surowe aluminium
97100000

Available lengths / Dostępne długości
1000 mm, 2000 mm, 3000 mm, 4000 mm

MOUNTING / MOCOWANIE

PHIL recessed holder
colour: inox
material: stainless steel
uchwyt PHIL wpust
kolor: inox
materiał: stal nierdzewna



INDEX = 1 set = 2 pcs
INDEKS = 1 komplet = 2 szt.

-  inox
inox **97510019**

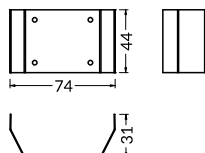

ENDINGS / ZAŚLEPKI

PHIL recessed ending
colours: white, silver, black
material: steel
zaślepka PHIL wpust
kolory: biały, srebrny, czarny
materiał: stal

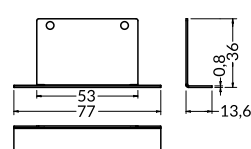

INDEX = 1 set = 2 pcs
INDEKS = 1 komplet = 2 szt.



-  white
biały **97120001**
-  silver
srebrny **97120022**
-  black
czarny **97120002**

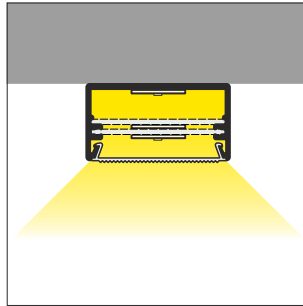
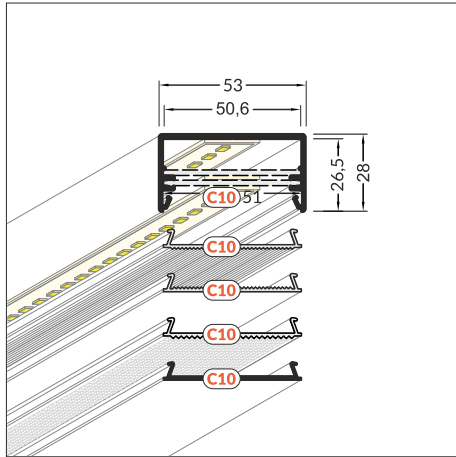

LOWI profile / profil LOWI



INDEX = 1 pc, length 2000 mm
INDEKS = 1 szt., długość 2000 mm

-  white painted
biały malowany
93030001
-  anodized
anodowany
93030020
-  black painted
czarny malowany
93030002
-  raw aluminium
surowe aluminium
93030000

Available lengths / Dostępne długości
1000 mm, 2000 mm, 3000 mm, 4000 mm

ENDINGS / ZAŚLEPKI

LOWI ending
colours: white, silver, black, grey
material: ABS

zaślepka LOWI
kolory: biały, srebrny, czarny, szary
materiał: ABS

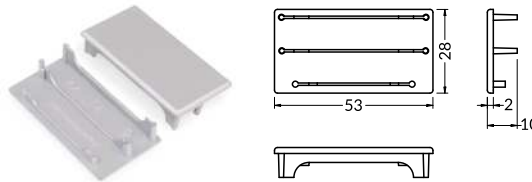

INDEX = 1 set = 2 pcs
INDEKS = 1 komplet = 2 szt.

-  white
biały **93040001**
-  silver
srebrny **93040040**
-  black
czarny **93040002**
-  grey
szary **93040022**

COVERS / KLOSZE

C10 NARROW cover
material: polycarbonate
klosz C10 NARROW
materiał: poliwęglan

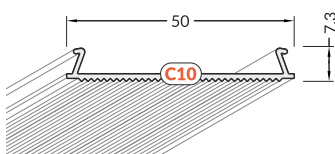

INDEX = 1 pc, length 2000 mm
INDEKS = 1 szt., długość 2000 mm

63620000

C10 WIDE cover
material: polycarbonate
klosz C10 WIDE
materiał: poliwęglan

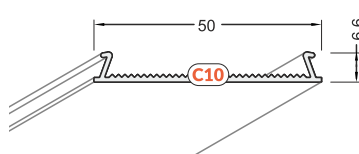

INDEX = 1 pc, length 2000 mm
INDEKS = 1 szt., długość 2000 mm

63590000

C10 OPAL cover
material: PMMA
klosz C10 OPAL
materiał: PMMA

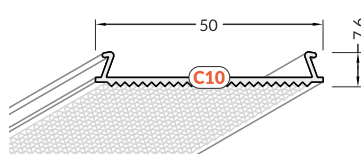

INDEX = 1 pc, length 2000 mm
INDEKS = 1 szt., długość 2000 mm

63690038

COVER / OSŁONA

C10 aluminium cover
material: aluminium
ostona aluminiowa C10
materiał: aluminium

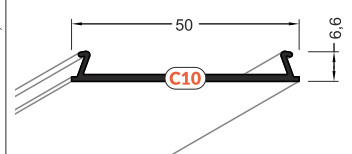

INDEX = 1 pc, length 2000 mm
INDEKS = 1 szt., długość 2000 mm

-  white painted
biały malowany
63560001
-  anodized
anodowany
63560020
-  black painted
czarny malowany
63560002
-  raw aluminium
surowe aluminium
63560000

Available lengths / Dostępne długości
1000 mm, 2000 mm, 3000 mm, 4000 mm

Comparison of variations in the light curves measured on different C10 covers
Porównanie krzywych światłości przy zastosowaniu różnych kloszki C10

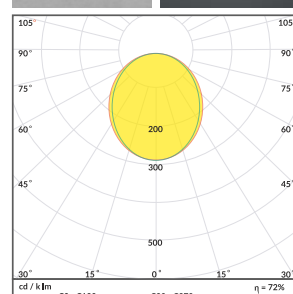
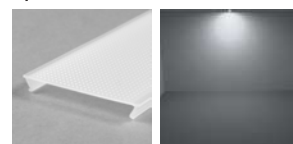
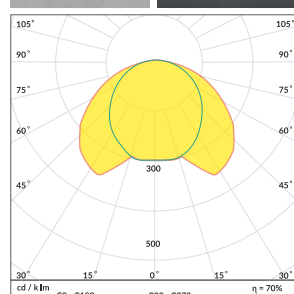
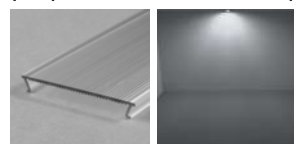
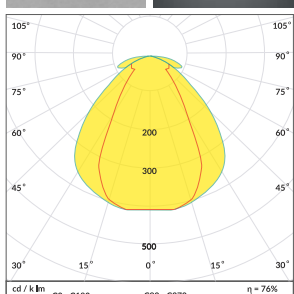
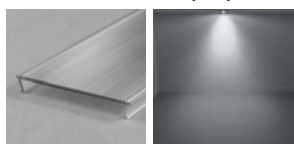



LED mounting 50
material: aluminium
mocowanie LED 50
materiał: aluminium

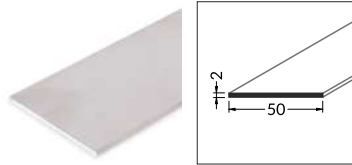

INDEX = 1 pc, length 2000 mm
INDEX = 1 szt., długość 2000 mm

raw aluminium
surowe aluminium 25090000

Available lengths / Dostępne długości
1000 mm, 2000 mm, 3000 mm, 4000 mm

DIMENSIONS TO INSTALL LIGHT SOURCE WYMIARY PRZESTRZENI DO ZAMONTOWANIA ŹRÓDŁA ŚWIATŁA

PHIL53 profile profil PHIL53

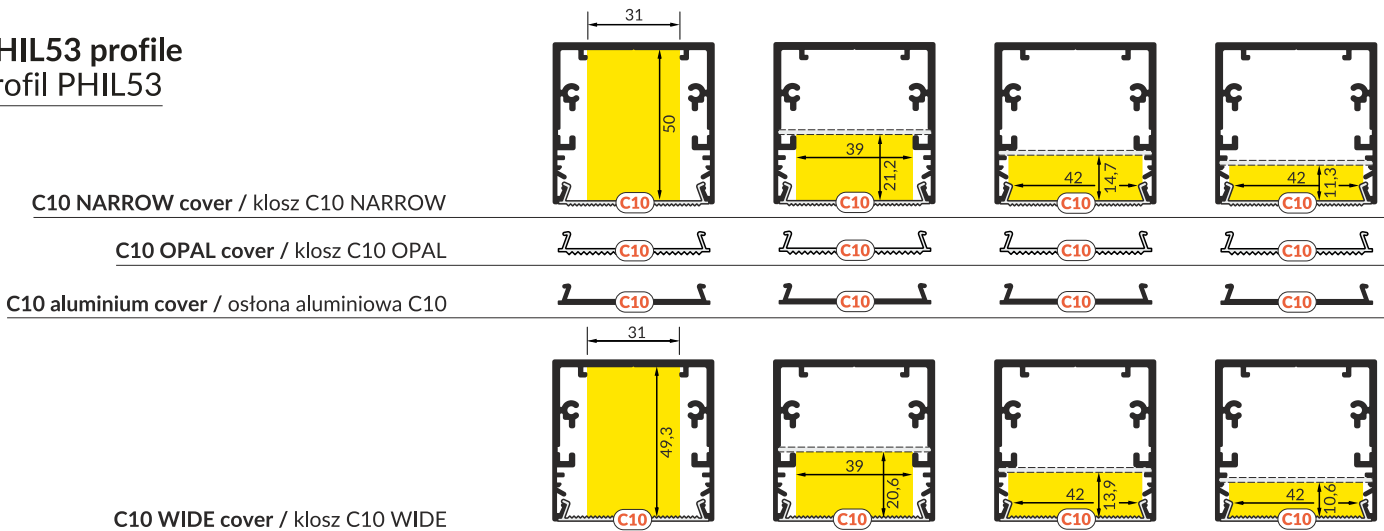

PHIL recessed profile profil PHIL wpust

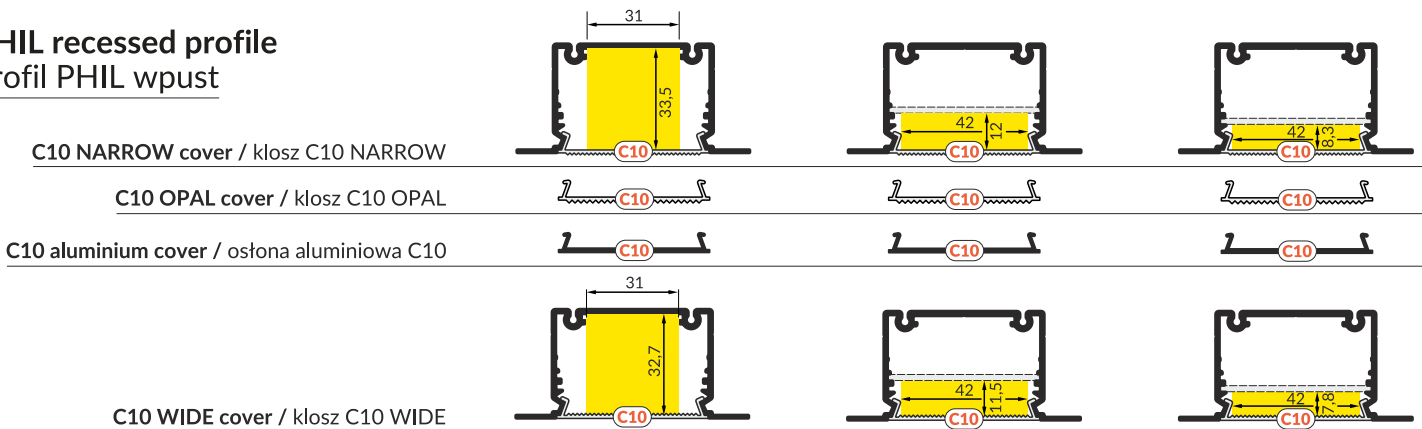

LOWI profile profil LOWI

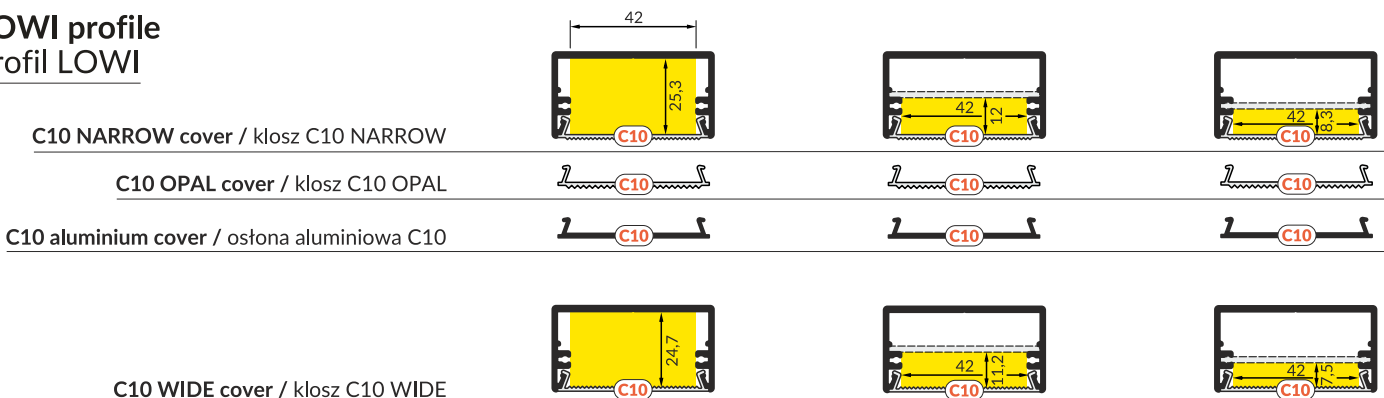



LED ACCESSORIES
AKCESORIA LED

2018

LED profiles
profile LED

PREMIUM LED strips (P)

taśmy LED z serii PREMIUM (P)



OSRAM LINEARlight VALUE Flex ECO VFEG1-FLX-300 (P) 24V; 4,2W/m

B4070000 - 827; 300 lm/m
B4080000 - 830; 330 lm/m
B4090000 - 865; 340 lm/m

MOQ = 1 reel = 9939 mm
minimalna ilość zamówienia = 1 rolka = 9939 mm

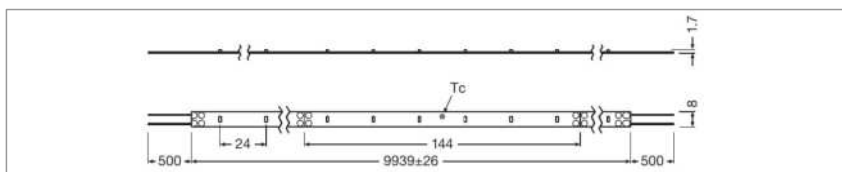

OSRAM LINEARlight VALUE Flex VF600-G2 (P) 24V; 7,7W/m

B4100000 - 827; 600 lm/m
B4110000 - 830; 600 lm/m
B4120000 - 840; 700 lm/m
B4130000 - 865; 700 lm/m

MOQ = 1 reel = 5998 mm
minimalna ilość zamówienia = 1 rolka = 5998 mm

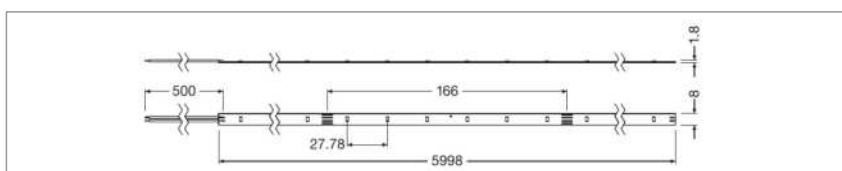
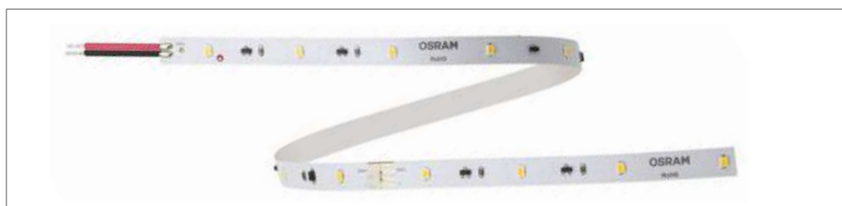

OSRAM LINEARlight VALUE Flex IP ECO VFEPG1-FLX-300 (P) 24V; 4,2W/m IP66 (water resistant • na zewnątrz)

B4140000 - 830; 250 lm/m
B4150000 - 860; 280 lm/m

MOQ = 1 reel = 6091 mm
minimalna ilość zamówienia = 1 rolka = 6091 mm

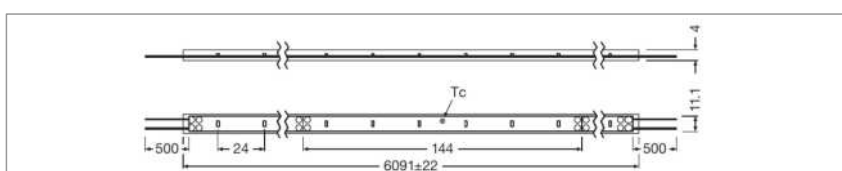

OSRAM LINEARlight VALUE Flex IP PROTECT VFP600-G2 (P) 24V; 7,7W/m IP66 (water resistant • na zewnątrz)

B4160000 - 830; 575 lm/m
B4170000 - 865; 600 lm/m

MOQ = 1 reel = 6018 mm
minimalna ilość zamówienia = 1 rolka = 6018 mm

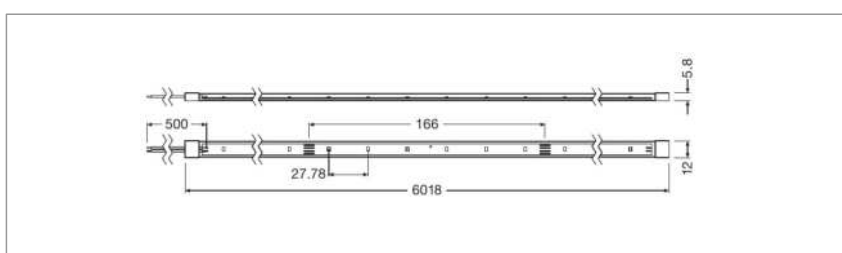

3 years warranty on LED strips when using OSRAM 24V power supplies
3 Lata gwarancji na taśmy wyłącznie z zasilaczami OSRAM 24V

see page 9.6 for OSRAM 24V power supplies • zasilacze do taśm OSRAM 24V patrz str. 9.6

STANDARD LED strips (S)

taśmy LED z serii STANDARD (S)

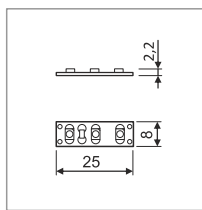
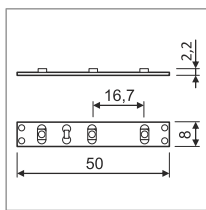

LED strip 3528 (S)
taśma LED 3528 (S)
12V; 4,8W/m; 60P/m

B4200000
2800-3200 K
360 lm/m ± 10%
Ra>80

B4210000
4000-4500 K
360 lm/m ± 10%
Ra>80

LED strip 3528 (S)
taśma LED 3528 (S)
12V; 9,6W/m; 120P/m

B4240000
2800-3200 K
720 lm/m ± 10%
Ra>80

B4250000
4000-4500 K
720 lm/m ± 10%
Ra>80

MOQ = 1 reel = 5 m

minimalna ilość zamówienia = 1 rolka = 5 m

BUDGET LED strips (B)

taśmy LED z serii BUDGET (B)

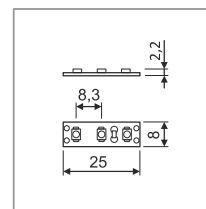
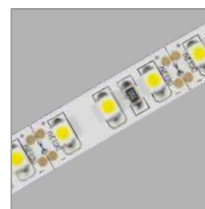
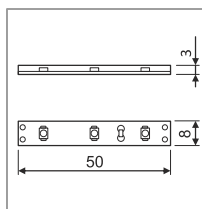
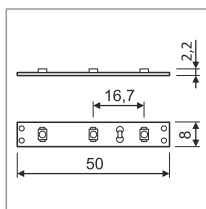
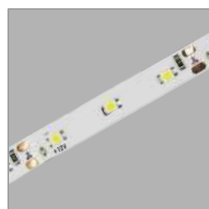

LED strip 3528 (B)
taśma LED 3528 (B)
12V; 4,8W/m; 60P/m

85414010
cool white
biały zimny

85414016
yellow
żółty

85414011
warm white
biały ciepły

85414017
red
czerwony

85414012
blue
niebieski

85414018
green
zielony

LED strip 3528 (B)
taśma LED 3528 (B)
12V; 4,8W/m; 60P/m; IP65

85414031
cool white
biały zimny

85414032
warm white
biały ciepły

LED strip 3528 (B)
taśma LED 3528 (B)
12V; 9,6W/m; 120P/m

85414055
cool white
biały zimny

85414056
warm white
biały ciepły

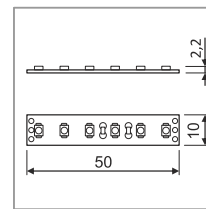
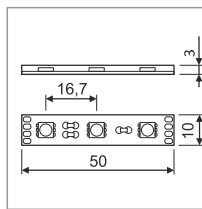
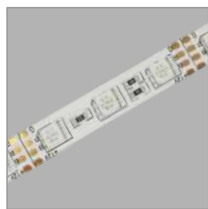
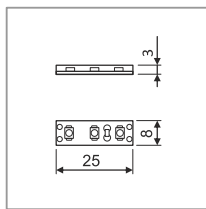
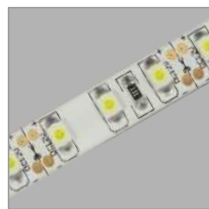

LED strip 3528 (B)
taśma LED 3528 (B)
12V; 9,6W/m; 120P/m; IP65

85414029
cool white
biały zimny

85414028
warm white
biały ciepły

LED strip 5050 RGB (B)
taśma LED 5050 RGB (B)
12V; 14,4W/m; 60P/m; IP65

85414077

LED strip 3528 warm-cool white (B)
taśma LED 3528 biały ciepły-zimny (B)
12V; 9,6W/m; 120P/m

84509900

MOQ = 1 reel = 5 m

minimalna ilość zamówienia 1 rolka = 5 m

see page 9.5 for power supplies
zasilacze do taśm patrz str. 9.5

TOPMET Light PREMIUM LED modules

moduły LED PREMIUM TOPMET Light

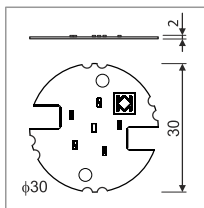
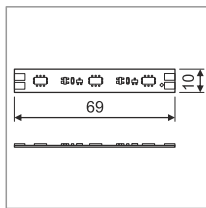

LED module

moduł LED

12V; 1,5W; 3led

85600300 - 2700 K 146 lm

85610300 - 3000 K 148 lm

85620300 - 4000 K 155 lm

Ra>80

LED module

moduł LED

12V; 1,5W; 6led

85414072 - 2700 K 106 lm

85414074 - 3000 K 110 lm

85414073 - 4000 K 115 lm

Ra>80

50 000 h durability of TOPMET Light PREMIUM LED modules

50 000 h trwałości modułów LED PREMIUM TOPMET Light

see page 9.5 for power supplies

zasilacze do modułów LED patrz str. 9.5

LED power supplies

zasilacze LED

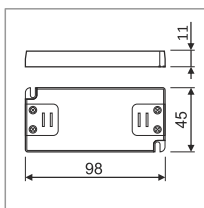

LED power supply
zasilacz LED
12V/6W; 200-240V

15700000

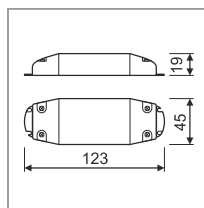

LED power supply
zasilacz LED
12V/15W; 200-240V

15850000

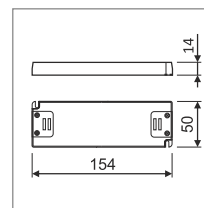

LED power supply
zasilacz LED
12V/20W; 200-240V

15640000

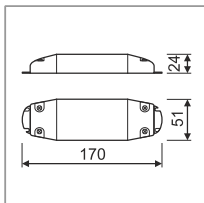

LED power supply
zasilacz LED
12V/30W; 200-240V

15810000

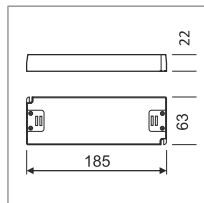

LED power supply
zasilacz LED
12V/50W; 200-240V

15650000

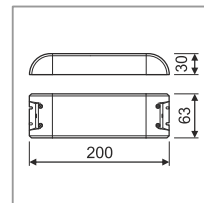

LED power supply
zasilacz LED
12V/75W; 200-240V

15800000

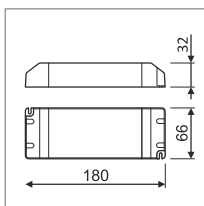

LED power supply
zasilacz LED
12V/100W; 100-240V

15760000

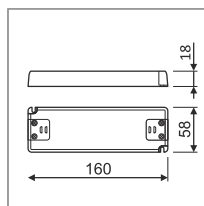

LED power supply
zasilacz LED
24V/30W; 200-240V

15770000

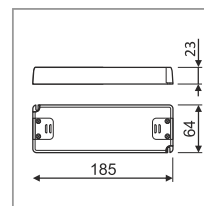

LED power supply
zasilacz LED
24V/60W; 200-240V

15780000

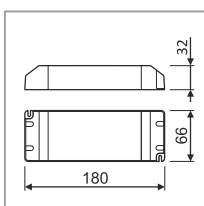

LED power supply
zasilacz LED
24V/100W; 100-240V

15790000

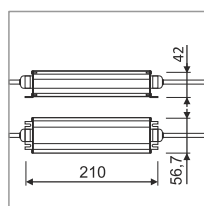

LED power supply
zasilacz LED
12V/100W; 200-240V; IP68

15710000

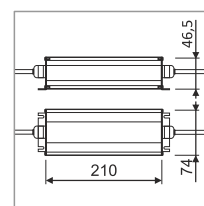

LED power supply
zasilacz LED
12V/150W; 200-240V; IP68

15720000

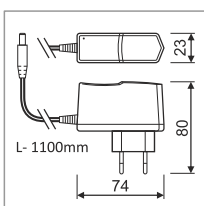

LED power supply AC adapter
zasilacz LED wtyczkowy
12V/12W; 100-240V

15480002

see pages 9.2-9.4 for LED modules and strips • moduły i taśmy LED patrz str. 9.2-9.4

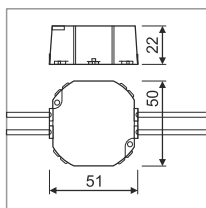

LED OSRAM OT power supply
zasilacz LED OSRAM OT
6W/200-240/24V CE

53430000

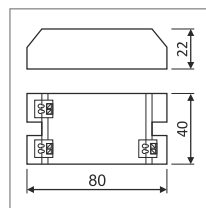

LED OSRAM OT power supply
zasilacz LED OSRAM OT
8W/200-240/24V

53440000

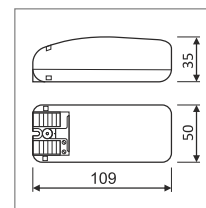

LED OSRAM OT power supply
zasilacz LED OSRAM OT
20W/220-240/24V

53450000

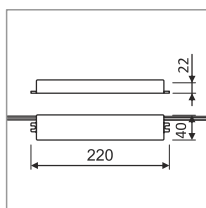

LED OSRAM OT power supply
zasilacz LED OSRAM OT
30W/220-240/24V P

53500000

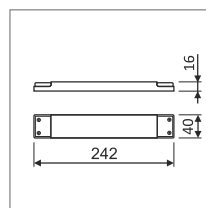

LED OSRAM OT power supply
zasilacz LED OSRAM OT
50W/220-240/24V

53470000

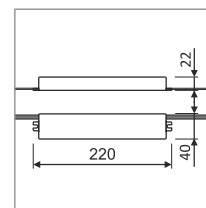

LED OSRAM OT power supply
zasilacz LED OSRAM OT
50W/220-240/24V P

53510000

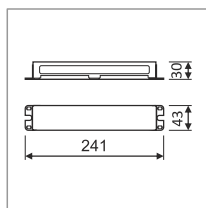

LED OSRAM OT power supply
zasilacz LED OSRAM OT
75W/220-240/24V E

53490000

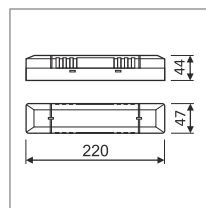

LED OSRAM OT power supply
zasilacz LED OSRAM OT
75W/220-240/24V

53480000

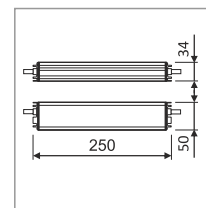

LED OSRAM OT power supply
zasilacz LED OSRAM OT
80W/220-240/24V P

53520000

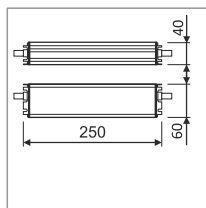

LED OSRAM OT power supply
zasilacz LED OSRAM OT
120W/220-240/24V P

53530000

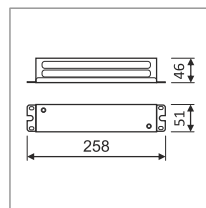

LED OSRAM OT power supply
zasilacz LED OSRAM OT
120W/220-240/24V E

53540000

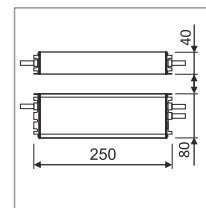

LED OSRAM OT power supply
zasilacz LED OSRAM OT
240W/220-240/24V P

53550000

see page 9.2 for OSRAM LED strips • taśmy LED OSRAM patrz str. 9.2

power supply cases

obudowy do zasilaczy

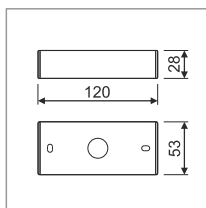

power supply case
obudowa do zasilacza
48 x 12 x 100

| | |
|----------|----------------|
| 67160001 | white • biały |
| 67160002 | black • czarny |
| 67160020 | anod. |

LED power supplies
maximum dimensions
maksymalne rozmiary
zasilaczy LED

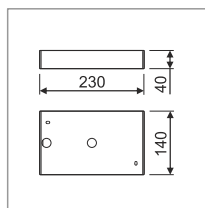
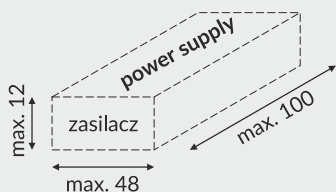

power supply case
obudowa do zasilacza
120 x 27 x 216

| | |
|----------|----------------|
| 67170001 | white • biały |
| 67170002 | black • czarny |
| 67170020 | anod. |

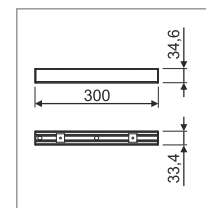
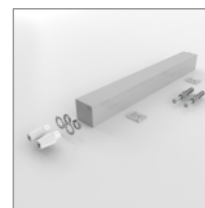

power supply case
obudowa do zasilacza
31 x 23 x 286

| | |
|----------|----------------|
| 67180001 | white • biały |
| 67180002 | black • czarny |
| 67180020 | anod. |

LED power supplies
maximum dimensions
maksymalne rozmiary
zasilaczy LED

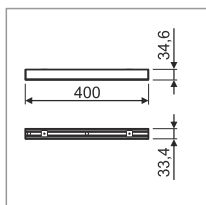
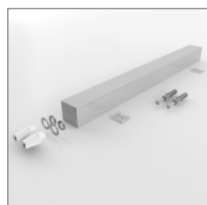
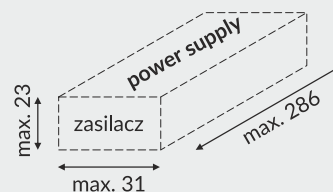

power supply case
obudowa do zasilacza
31 x 23 x 386

| | |
|----------|----------------|
| 67190001 | white • biały |
| 67190002 | black • czarny |
| 67190020 | anod. |

LED power supplies
maximum dimensions
maksymalne rozmiary
zasilaczy LED

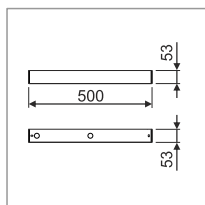
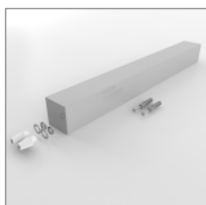
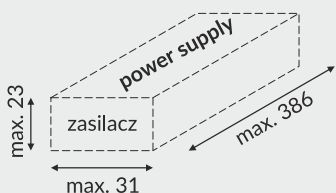

power supply case
obudowa do zasilacza
36 x 46 x 474

| | |
|----------|----------------|
| 67200001 | white • biały |
| 67200002 | black • czarny |
| 67200020 | anod. |

LED power supplies
maximum dimensions
maksymalne rozmiary
zasilaczy LED

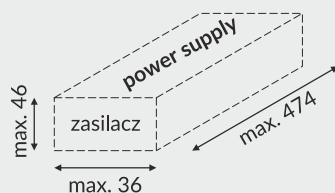

see pages 9.5-9.6 for power supplies
zasilacze do modułów LED patrz str. 9.5-9.6

lighting controllers and switches

czujniki sterujące i włączniki

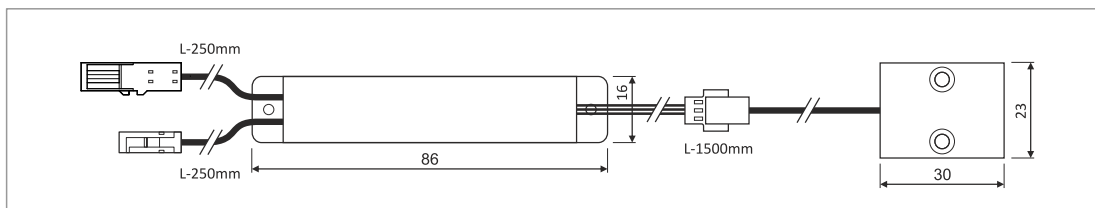

door operated sensor switch
włącznik bezdotykowy drzwiowy
12-24V/30W

15530000

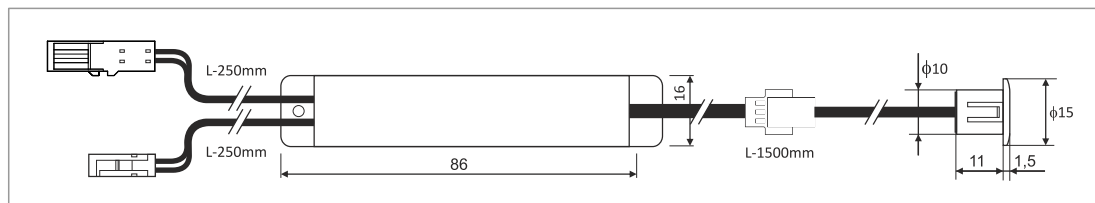

hand operated sensor switch
włącznik bezdotykowy ręczny
12-24V/30W

15540000

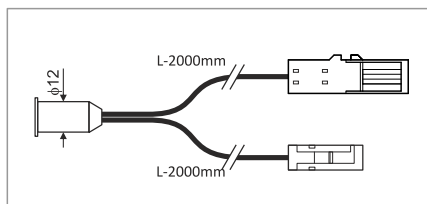

touch sensor ON/OFF switch
włącznik dotykowy ON/OFF
12V/30W

15630000

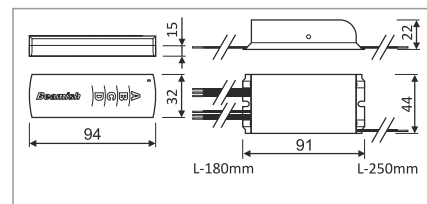

3 channel remote controller ON/OFF
pilot z włącznikiem radiowym 3-kanalowy ON/OFF
230V/1000W

78530000

lighting controllers and switches

czujniki sterujące i włączniki



LED SU/GR/CO dimmable switch
włącznik LED SU/GR/CO ściemniający
12-24V/35W

53850000



LED SU/GR/CO dimmable, touchless switch
włącznik LED SU/GR/CO ściemniający bezdotykowy
12-24V/35W

53860000

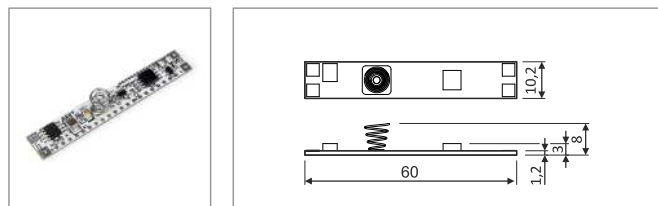

touch LED INSIDE dimmable switch
włącznik dotykowy ściemniający LED INSIDE
12-24V/36W

C5010000

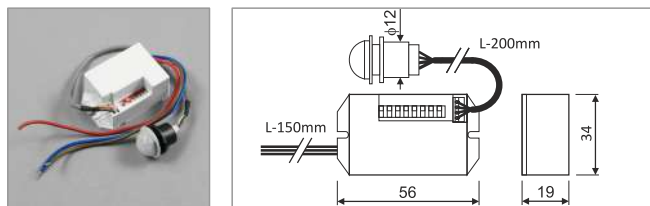

movement sensor YCB1050
czujnik ruchu YCB1050
230V/800W

85414061

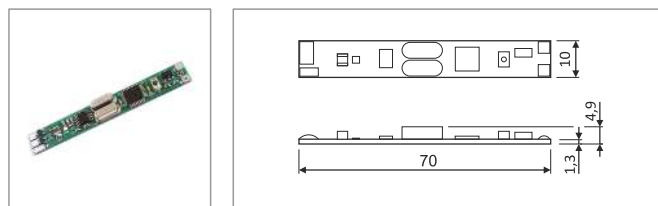

LED 1 channel basic receiver
moduł sterujący LED podstawowy 1 kanałowy
12V-24V/72W

C5020000

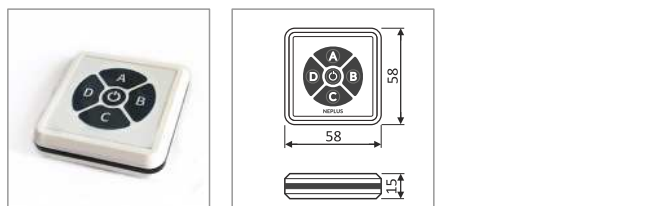

LED 4 channel basic remote controller
pilot sterujący LED podstawowy 4 kanałowy

C5030000

RGB lighting system

system oświetlenia RGB

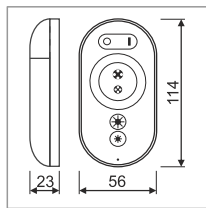
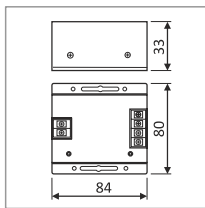

LED RGB remote controller operates with multiple drivers.
Pilot może obsługiwać kilka sterowników jednocześnie.

LED 3 channel RGB receiver
moduł sterujący
LED RGB 3 kanałowy
12V/24VDC; 216W/432W

78450000

LED RGB remote controller
pilot sterujący LED RGB

78460000

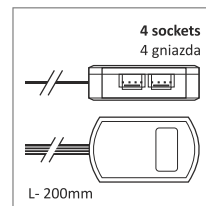
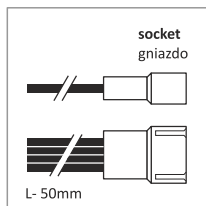
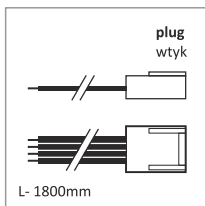

LED RGB cable with plug
przewód LED RGB 1xW
4x0,5; L-1800; MIKRO4

67060000

LED RGB cable with socket
przewód LED RGB 1xG
4x0,5; L-50; MIKRO4

67050000

LED RGB 4 way distribution box
rozdzielacz LED
zintegrowany RGB 4xG
4x0,5; L-200; MIKRO4

67040000

see page 9.3 for LED strips • taśmy LED patrz str. 9.3

Vario white lighting system

system oświetlenia Vario white

warm/cold white controllers • piloty sterujące ciepła/zimna biel

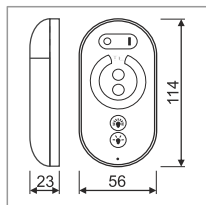
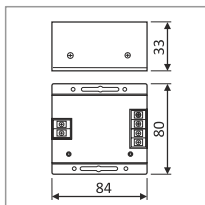

LED remote controller operates with multiple drivers.
Pilot może obsługiwać kilka sterowników jednocześnie.

LED 2 channel warm-cold receiver
moduł sterujący LED ciepły-zimny
2 kanałowy
12V/24VDC; 144W/288W

78300000

LED remote controller warm-cold
pilot sterujący LED
ciepły-zimny

78290000

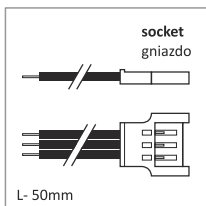
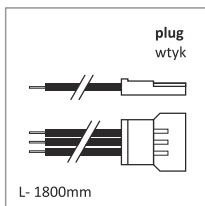

LED cable with plug
przewód LED 1xW
3x0,22; L-1800; MIKRO3

67030000

LED cable with socket
przewód LED 1xG
3x0,22; L-50; MIKRO3; 1xG

67020000

see pages 9.2-9.3 for LED strips • taśmy LED patrz str. 9.2-9.3

LED profile slings

zawiesia do profili LED



SELV sling
zawiesie SELV
50V; 1500

1 set = 2 pcs
1 kpl. = 2 szt.

| | |
|----------|-----------------|
| 67120001 | white • biały |
| 67120002 | black • czarny |
| 67120022 | silver • srebro |

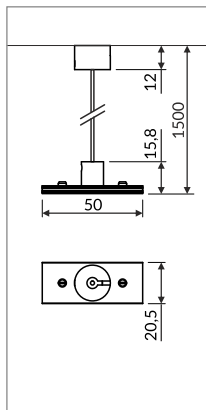

sling for LED mounting 1500
zawiesie do uchwytu LED 1500

1 set = 2 pcs
1 kpl. = 2 szt.

| | |
|----------|----------------|
| 67140003 | chrome • chrom |
|----------|----------------|

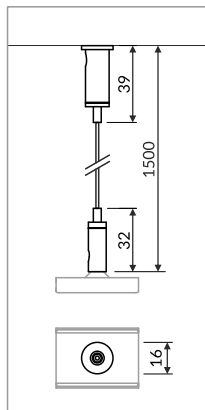

large sling
zawiesie duże

1 set = 2 pcs
1 kpl. = 2 szt.

| | | |
|----------|--------|----------------|
| 43100003 | 1500mm | chrome • chrom |
| 43110003 | 3000mm | chrome • chrom |

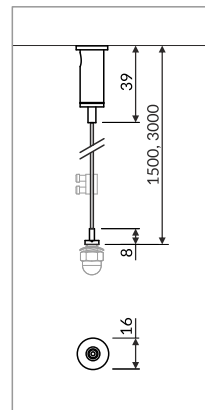

SKB sling
zawiesie SKB

1 set = 1 pc
1 kpl. = 1 szt.

| | | |
|----------|--------|----------------|
| 67160003 | 1500mm | chrome • chrom |
| 67170003 | 3000mm | chrome • chrom |

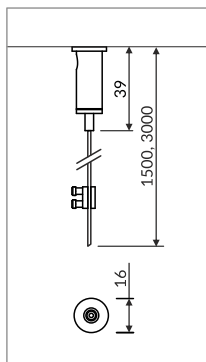

tilted bracket for LED profiles

uchwyt uchylny do profili LED



tilted bracket
uchwyt uchylny

1 set = 2 pcs
1 kpl. = 2 szt.

| | |
|----------|-----------------|
| 67230022 | grey • szary |
| 67230001 | white • biały |
| 67230002 | black • czarny |
| 67230040 | silver • srebro |

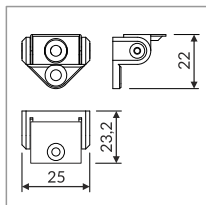

tilted bracket compatible with cone flexible mounting plates:
- U5, U6, U, W, Y, Z

cone flexible mounting plates not included

uchwyt uchylny kompatybilny z uchwytami sprężystymi cone:
- U5, U6, U, W, Y, Z

komplet nie zawiera uchwytów sprężystych cone

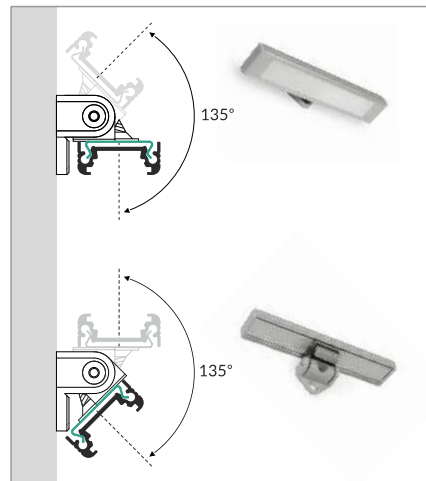

cables, extensions, connectors

przewody, przedłużacze, złączki

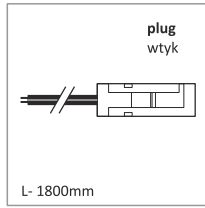

LED cable with MINI PLUG / black
przewód LED MINI 1xW / czarny
2x0,35; L-1800

85430002

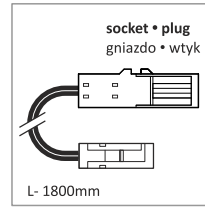

LED extension cable with MINI socket and plug / black
przedłużacz LED
MINI 1xG/1xW / czarny
2x0,35; L-1800

85460002

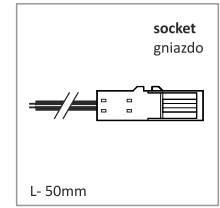

LED cable with MINI socket / black
przewód LED MINI 1xG / czarny
2x0,35; L-50

85580002

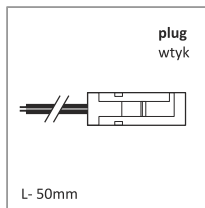

LED cable with MINI plug / black
przewód LED MINI 1xW / czarny
2x0,35; L-50

85570002

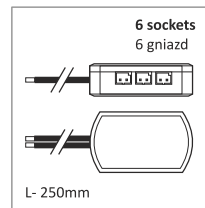

LED 6 way MINI distribution box / black
rozdzielacz LED
zintegrowany MINI 6xG / czarny
2x0,5; L-250

85366900

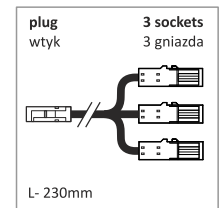

LED cable with MINI 3 sockets and 1 plug / black
rozdzielacz LED
MINI 3xG/1xW / czarny
2x0,35; L-230

85470002

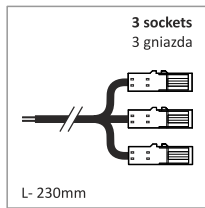

LED cable with 3 MINI sockets / black
rozdzielacz LED MINI 3xG / czarny
2x0,35; L-230

85590002

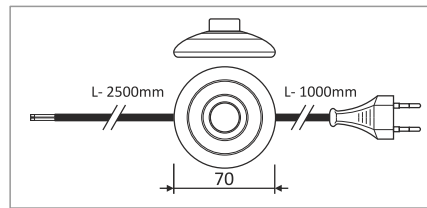

cable with footswitch and plug / black
przewód z włącznikiem nożnym / czarny
250V; 2x0,75; 2,5A; L-1000/2500

67110002

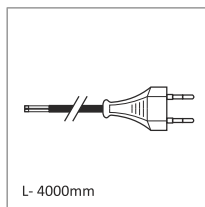

cable with plug / black
przewód 1xW / czarny
250V; 2x0,75; 2,5A; L-4000

67100002

other accessories

pozostałe akcesoria

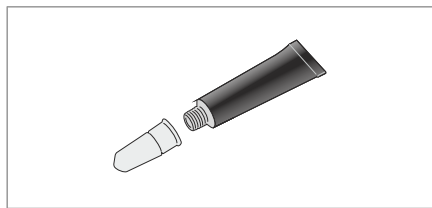

**quick-drying adhesive
mounting gel**
3g
klej do mocowania w żelu

76640000



**cleaning rubber
for anodized surfaces**
gumka do czyszczenia
powierzchni anodowanych

25250000

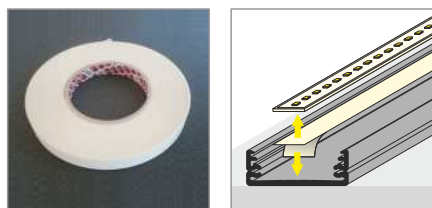

**double-sided, self adhesive,
thermally conductive tape**
taśma termoprzewodząca dwustronna
15 mm x 50 m

67990000 1 roll

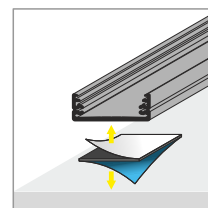
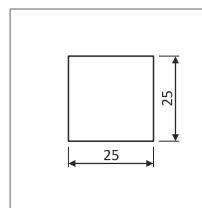
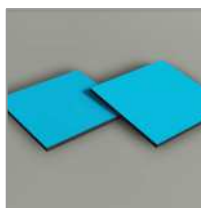

double-sided non conductive tape
taśma mocująca dwustronna
nieprzewodząca 25 mm x 25 mm

76340000

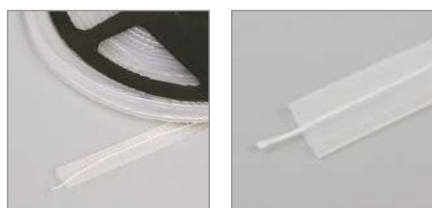

silicone housing for 8 mm LED strip
osłona silikonowa do taśmy LED 8 mm
11 mm x 5 mm x 5 mm

67980000

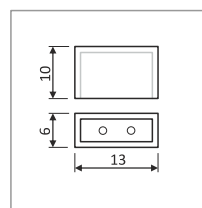
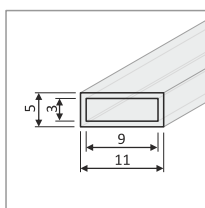

ending for silicone housing for 8 mm LED strip
zaślepka do osłony silikonowej do taśmy LED 8 mm

1 set = 2 pcs (ending with hole, ending without hole)
1 kpl. = 2 szt. (zaślepka z otworem, zaślepka bez otworu)

67970000s



GENERAL INFORMATION
INFORMACJE OGÓLNE

2018

LED profiles
profile LED

Why LED profiles? / Dlaczego profile LED?

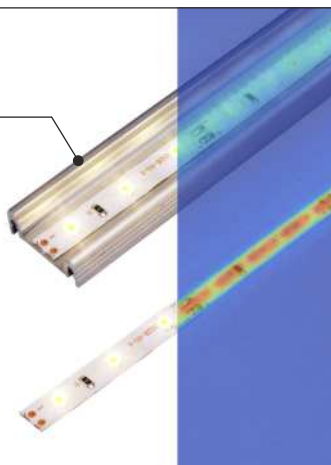
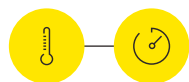

HEAT DISSIPATION

An aluminium profile is a radiator - it dissipates heat from the LED source. Lower temperature means better operating conditions for the diodes, therefore, extension of the LED lifespan and better illumination parameters. It also translates to economic considerations - LED does not require such frequent replacement of light sources. An aluminium profile is an investment, which pays off.



Some LED sources available on the market may exceed radiation capabilities of a given aluminium profile. In order to ensure correct operation, a LED source with appropriate parameters needs to be matched to an aluminium profile.

ODPROWADZANIE CIEPŁA

Profil aluminiowy jest radiatorem - odprowadza ciepło ze źródła LED. Niższa temperatura to lepsze warunki pracy dla diod, a tym samym przedłużenie żywotności LED i lepsze parametry świetlne. Przekłada się to również na względy ekonomiczne - LED nie wymaga tak częstych wymian źródeł światła. Profil aluminiowy to inwestycja, która się opłaca.



Niektóre źródła LED dostępne na rynku mogą przekraczać radiacyjne możliwości wybranego profilu aluminiowego. W celu zapewnienia poprawnego działania, należy dobrać do profilu aluminiowego źródło LED o odpowiednich parametrach.



AESTHETICS / STRIP PROTECTION

An aluminium profile is a protection for a LED source against mechanical damage. The assembly is much more durable in comparison to gluing a LED strip directly to the surface. Using a profile increases aesthetics and facilitates maintaining cleanliness.

ESTETYKA / OCHRONA TAŚMY

Profil aluminiowy stanowi zabezpieczenie źródła LED przed mechanicznym uszkodzeniem. Montaż jest znacznie trwalszy w porównaniu z przyklejeniem taśmy LED bezpośrednio do podłoża. Użycie profilu podwyższa estetykę oraz ułatwia utrzymanie czystości.



ANODIZED COATING / COLOUR VERSIONS

In the standard TOPMET offer, aluminium LED profiles are available in 4 basic finishes:
white painted - powder coated,
anodised aluminium in silver colour,
anodised aluminium in black colour,
raw aluminium - economic version, not resistant to damage.

The most eagerly used ones are the anodized versions with a high degree of scratch resistance. The thickness of the anodic coating on all our profiles is about 15 μm .

ANODOWANA POWŁOKA / WERSJE KOLORYSTYCZNE

W standardowej ofercie TOPMET profile aluminiowe LED występują w 4 podstawowych wykończeniach:
biały malowany - powłoka farby proszkowej,
aluminium anodowane w kolorze srebrnym,
aluminium anodowane w kolorze czarnym,
aluminium surowe - wersja ekonomiczna, nieodporna na uszkodzenia.

Najchętniej stosowane są wersje anodowane o wysokim stopniu odporności na zarysowania. Grubość powłoki anodowej na wszystkich naszych profilach to około 15 μm .



ACCESSORIES

The design department is constantly working on expanding the offer with further components, which facilitate the assembly and multiply the possibilities of combinations, connections and assembly. Apart from system mounting plates, which match different profiles, many collections also have dedicated solutions for more advanced, specialist needs. The accessories for LED profiles include, i.a.: endings, covers, mounting plates, holders, extension arms, connectors, clamps, slings and many more.

AKCESORIA

Dział projektowy stale pracuje nad wzbogaceniem oferty w kolejne komponenty, które ułatwiają montaż i wielokrotnie zwiększają możliwości kombinacji, połączeń, montażu. Poza uchwytami systemowymi, pasującymi do różnych profili, wiele kolekcji ma także dedykowane rozwiązania do bardziej zaawansowanych, specjalistycznych potrzeb. Wśród akcesoriów do profili LED są m.in.: zaślepki, klosze, uchwyty, wysięgniki, łączniki, dociski, zawieszaki i wiele innych.



EU-registered industrial design
Wzory przemysłowe EU



PL
Made in Poland
Wyprodukowane w Polsce

DESING / PRODUCTION

All profiles are unique - designed by TOPMET designers.
All the designs are registered - legally protected throughout the European Union.
TOPMET profiles, accessories and luminaires are manufactured in Poland.

PROJEKT / PRODUKCJA

Wszystkie profile są unikatowe – zaprojektowane przez projektantów TOPMET.
Wszystkie wzory są zarejestrowane – chronione prawnie na terenie całej Unii Europejskiej.
Profile, akcesoria i oprawy TOPMET wyprodukowane są w Polsce.



Why is it worth to choose LED technology? Dlaczego warto wybrać technologię LED?

ECONOMY / EKONOMIA

Comparison of light sources of similar lumen output / Porównanie źródeł światła o zbliżonej wartości strumienia świetlnego



traditional bulb
żarówka tradycyjna
power / moc: 100 W
price / cena: 0,78 €



halogen source
żarówka halogenowa
power / moc: 70 W
price / cena: 1,19 €



LED source
źródło LED
power / moc: 11,5 W
price / cena: 9,50 €

Energy / Energia

Watts necessary to obtain lumen output of 1000 lm / Ilość watów potrzebna do uzyskania światła o strumieniu 1000 lm

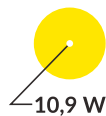
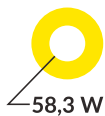
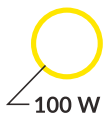

Lifespan / Żywotność

Time in hours for which one light source will glow until the lumen output decreases by 20 - 30% compared to the initial value

Czas podany w godzinach, w którym będzie świecić jedna żarówka zanim wartość strumienia świetlnego zmniejszy się o 20 - 30% w stosunku do wartości początkowej



Expenses / Wydatki

Amount and costs of worn-out light sources during one LED source lifespan / Ilość i koszt zużytych źródeł światła w okresie żywotności jednego źródła LED

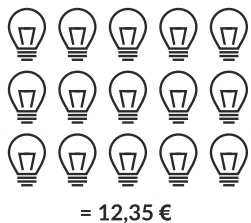

Daily costs of energy if the light glows for 8h* / Koszt energii z jednego dnia przy świetle zapalonym przez 8 h*

0,11 €

0,07 €

0,01 €

Costs of energy throughout the LED source lifespan* / Koszt energii z całego okresu żywotności źródła LED*

203,58 €

142,50 €

23,41 €

Total cost / Suma kosztów

of operation and light source prices** / eksploatacji oraz ceny źródła światła**

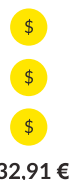

How much can you save by using a LED light source? ** / Ile można zaoszczędzić stosując źródło LED? **



In relation to traditional bulb
W stosunku do tradycyjnej żarówki
183,01 €



In relation to halogen source
W stosunku do żarówki halogenowej
118,55 €

* assuming the rate per 1 kWh at a level of: 0,14 € / przy założeniu stawki za 1 kWh na poziomie 0,14 €

** throughout the LED source lifespan / w całym okresie żywotności źródła LED

ECOLOGY / EKOLOGIA



What we should pay particular attention to is the impact of everyday use devices on the natural environment. And so, lights using the LED technology are biodegradable, have a longer lifespan compared to traditional sources and consume less energy. Moreover, LED does not contain mercury.

less source replacements = less waste reaching the environment

To, na co powinniśmy zwrócić największą uwagę, to oddziaływanie na środowisko naturalne urządzeń codziennego użytku. I tak, światła wykorzystujące technologię LED są biodegradowalne, mają większą żywotność w stosunku do tradycyjnych źródeł oraz zużywają mniej energii. Ponadto LED nie zawiera rtęci.

mniej wymian źródeł = mniej odpadów trafiających do środowiska





SALES SUPPORT
WSPARCIE SPRZEDAŻY

2018

LED profiles
profile LED

Sales support / Wsparcie sprzedaży

LED PROFILES SAMPLE BOX



LED PROFILES SAMPLE CASE



LED profiles / profile LED



VARIO30



big profiles / duże profile



LED PROFILES SAMPLE BOARD



LED PROFILES DISPLAY STAND

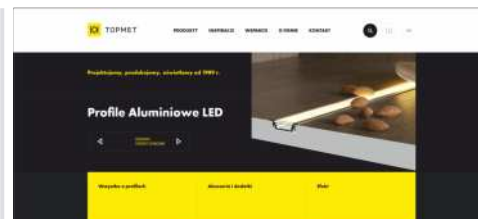

www.topmet.co.uk
www.topmet.pl



professional consultancy service
profesjonalne doradztwo



LED luminares catalogues
karty katalogowe opraw LED



General terms and conditions available
on website:

<http://www.topmet.pl/en/tc/>

Ogólne warunki gwarancji dostępne
są na stronie:

<http://www.topmet.pl/pl/polityka-prywatnosci/>

marking of covers fitting the sockets in the profile

oznaczenia kloszy pasujących do gniazd w profilu



marking of holders fitting the profile

oznaczenia uchwytów pasujących do profilu



profile with Slick socket

profil z gniazdem Slick



LED profile categories

kategorie profili LED



surface
nawierzchniowy



recessed
wpustowy



corner
kątowy



special application
specjalny



glass application
do szkła

pictograms

piktogramy



maximum LED strip width
maksymalna szerokość taśmy LED



note
uwaga



assembly adhesive
klej montażowy



available in stock
dostępny na magazynie



made in Poland
wyprodukowane w Polsce



EU-registered industrial design
wzory przemysłowe EU

**SURFACE
NAWIERZCHNIOWE**

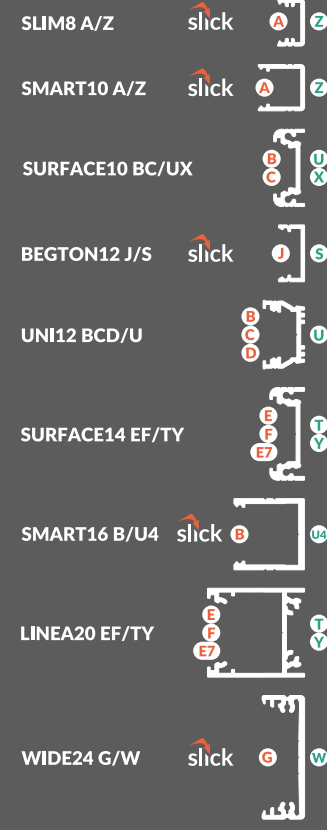

**SPECIAL APPLICATION
SPECJALNE**

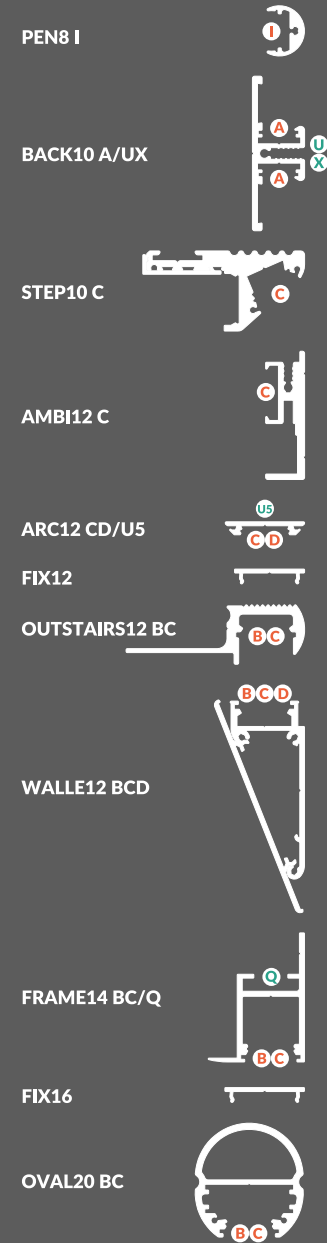

**RECESSED
WPUSTOWE**

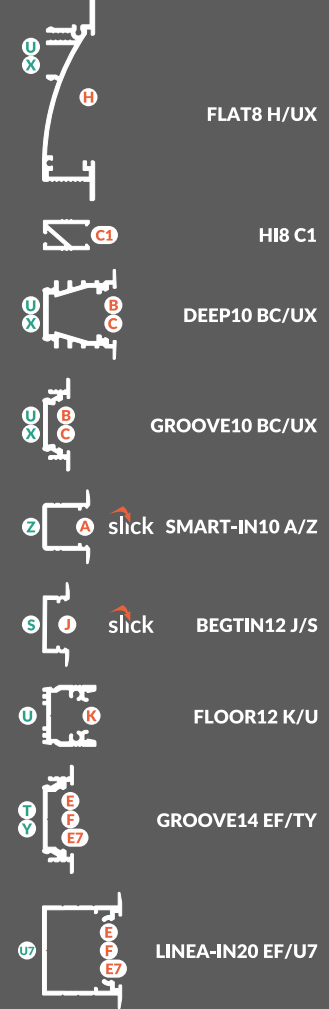

**CORNER
KĄTOWE**

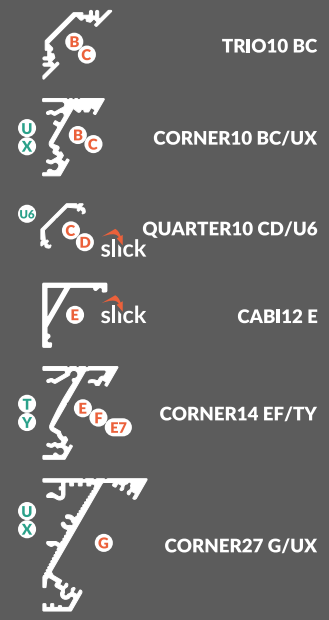

**GLASS APPLICATION
DO SZKŁA**

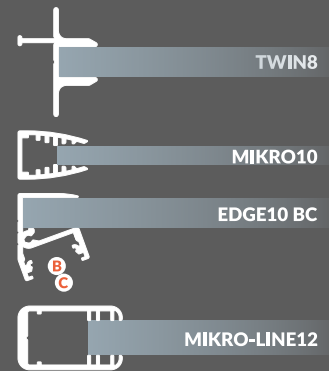



Made in Poland
Wyprodukowane w Polsce



EU-registered industrial design
Wzory przemysłowe EU

**TOPMET LIGHT Kłosowicz Wiśniewski i Wspólnik Sp. j. ADDRESS: Ostrowska 354, 61-312 Poznań, POLAND
tel. +48 61 87 27 500, fax. +48 61 87 27 518 biuro@topmet.pl, www.topmet.pl**

The catalogue is not an offer under Polish Civil Code regulations. Colours of particular products may vary slightly from colours shown in pictures. The dimensions given are approximate and can not be a reason for complaint. TOPMET Company reserves the right to make technical changes.

Katalog nie stanowi oferty w myśl przepisów Kodeksu Cywilnego. Aktualną ofertę firmy stanowi cennik. Kolory poszczególnych produktów mogą się nieznacznie różnić od kolorów prezentowanych na zdjęciach. Podane wymiary są wymiarami orientacyjnymi i nie mogą stanowić podstawy reklamacji. Firma TOPMET zastrzega sobie prawo do wprowadzania zmian technicznych.

catalogue designer • proj. folderu: M. Kędziora, A. Szafran 08.2017. photo • fot.: K. Samulska, A. Szafran, S. Wawrzyn, L. Wesołowski, A. Wierdak
visualisations • wizualizacje: M. Kędziora, A. Szafran, P. Wos

Dystrybutor / Dystrybutor